



COLLEGIATE
COMMISSIONERS
ASSOCIATION

2023

SOFTBALL UMPIRES

MANUAL

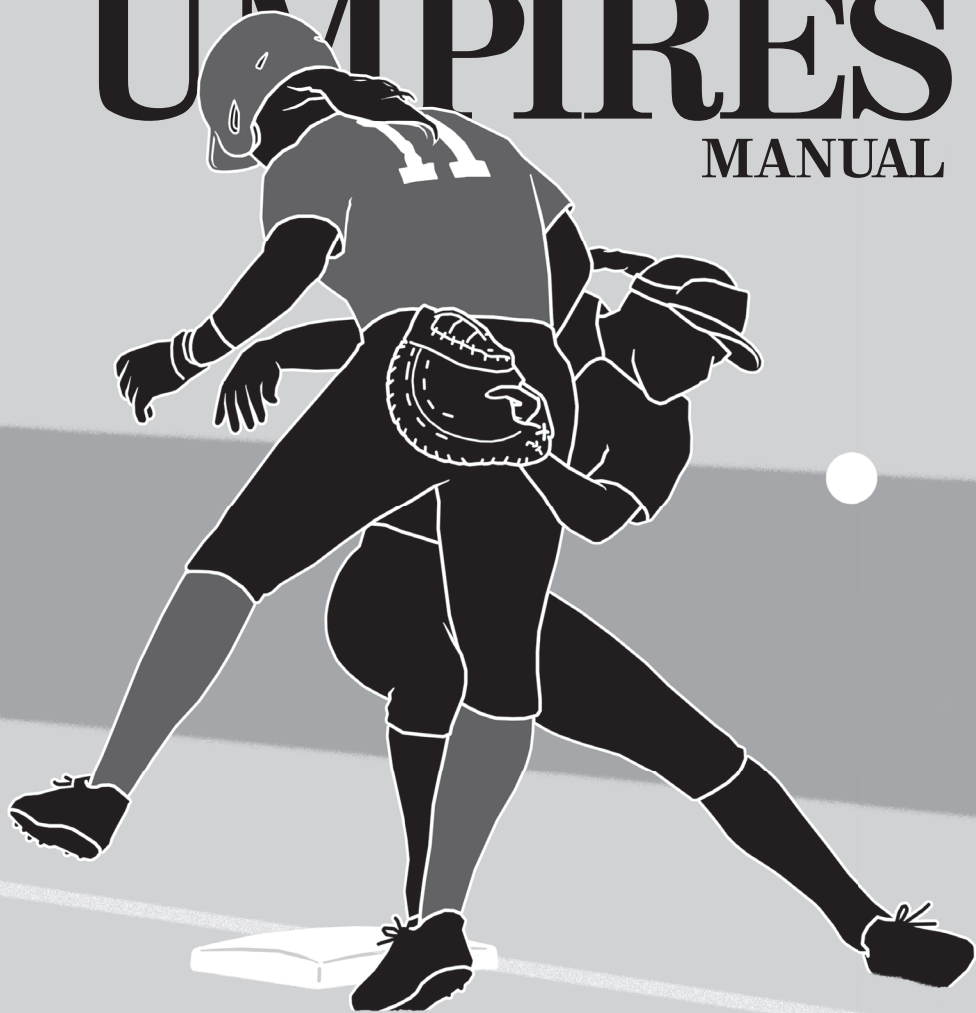

FOR CREWS OF TWO & THREE UMPIRES



STANDING BEHIND YOU AND YOUR GAME

Baseball • Basketball • Football • Lacrosse • Soccer
Softball • Volleyball • Wrestling

NASO
PREFERRED VENDOR





COLLEGIATE
COMMISSIONERS
ASSOCIATION

**Softball Umpires
Manual 2023**

Softball Umpires Manual 2023

Copyright © 2023 by the Collegiate Commissioners Association
To order, contact Referee Enterprises, Inc., at 262-632-8855.

Produced by Referee Enterprises, Inc., publishers of *Referee* magazine.

Major portions of this book are protected by copyrights of Referee Enterprises, Inc., and are used by permission. Copying in whole or in part is prohibited without prior written consent from Referee Enterprises, Inc. *and* the Collegiate Commissioners Association. PlayPic® and MechaniGram® are registered trademarks of Referee Enterprises, Inc.

Printed in the United States of America.

ISBN-13: 978-1-58208-541-8

Table of Contents

Introduction	7
SECTION 1 — Opening Pitch	8
SECTION 2 — Manual Changes/Additions.....	10
New Mechanics	10
Mechanics Changes/Updates	11
In-Game Guidance	11
Professionalism Update	15
SECTION 3 — Responsibilities	17
Preparation	18
Expectations	18
Social Media Guidelines	20
Policies	21
Uniform and Equipment	23
SECTION 4 — Pregame Administration	25
Before the Game	25
Equipment Check	26
SECTION 5 — General Game Information	28
Game Management	28
Replay Procedures	29
General Guidance for Handling Player Altercations — Early Intervention	29
Warnings	30
Behavioral and Administrative Ejections	32
Managing Ejections	33
Protests	34
Forfeits	35
Submitting Report	35
SECTION 6 — In-Game Umpiring/Situations	37
Crewness	37
The Value of Verbal	37
Strike Zone	38
Option Plays	40
Correcting the Count	41
Base Umpires Returning From Outfield Ball Coverage	42
Checking the Pitcher’s Resin Bag	42
Hit By Pitch	43
Hit By Pitch vs Off the Bat	43
Time Between Pitches Violation	44
Leaving Before the Pitch is Released	44
One Umpire Calls Obstruction and Another Has Play on That Runner	44
Interference, Obstruction, or Contact Between Two Umpires	45
Timing Play	45
Getting the Call Right/Going for Help	46
Conference Management	47
At the Conclusion of the Game	48
SECTION 7 — Mechanics	50
Crewness Through Mechanics	50
All Umpire Positions	51
Plate Umpire	57
Base Umpires	62

First Base Umpire	63
Third Base Umpire.....	64
Situational Mechanics	66
SECTION 8 — Signals	67
Standard Umpire Signals	68
Umpire-to-Umpire Signals	78
Three-Person Mechanics Key	82
SECTION 9 — Three-Umpire System	83
No Runners on Base	84
Runner on First	108
Runner on Second	136
Runner on Third	162
Runners on First and Second	188
Runners on First and Third	214
Runners on Second and Third	240
Bases Loaded	266
Between Inning Positions	298
Two-Person Mechanics Key	292
SECTION 10 — Two-Umpire System	293
Starting Positions	295
Between Inning Positions	296
Plate Umpire Responsibilities	296
Base Umpire Responsibilities	296
Tag-Up Responsibilities	297
Chasing Fly Balls	297
No Runners on Base	300
Runner on First	308
Runner on Second	318
Runner on Third	326
Runners on First and Second	334
Runners on First and Third	342
Runners on Second and Third	350
Bases Loaded	358
SECTION 11 — Definitions	366

Introduction

The integrity of college softball games is entrusted to its umpires. For the most part college softball umpires officiate as an avocation and are representatives of what is good in amateur athletics. The NCAA, its member conferences and game participants appreciate the efforts of college softball umpires.

This manual assumes a basic knowledge of umpiring fundamentals, and it is meant to inform umpires of the preferred methods and expectations of umpiring college softball. It provides a consistent system that offers the very best field coverage for college softball umpires. Uniformity of performance and rules interpretations by all umpires is an absolute necessity. This manual provides uniformity.

Conferences may have policies in place that are not listed in this manual. Conference umpires need to review their respective conference policies and procedures on softball umpiring.

A thorough understanding of the materials and statements of the NCAA must supplement knowledge of the procedures outlined in this manual. Intelligence, imagination, perspective and good judgment must be combined with study and interpretation of both the rulebook and mechanics manual.



Opening Pitch

Message From Steve McCown

NCAA National Coordinator of Softball Officials



Welcome back for the 2023 Softball season. To say that the staff is excited about the direction our program is going would be an understatement.

We have expanded our staff and the number of umpires on committees to allow for more ownership and transparency.

We are reinstating a progression for advancement in post season.

We are aligning ourselves with the direction of the NCAA and intend to be a leader in the recruiting and retention of officials, which includes diversity and inclusion.

You will find that “Work to the Manual” is going to be a reoccurring theme. We are looking to promote athleticism and purposeful movement. We continue to eliminate gray areas that result in umpires taking liberties that were not the intent of the mechanic and we have simplified the Chase/Coverage verbiage.

We have been encouraged by the number of young umpires coming through camps this Summer. Great listeners, energetic and eager to do what’s right. Competition will make us all better umpires.

The transition to RefQuest is in full swing. There will obviously be a learning curve for everyone, but the advanced messaging, video library and testing will prove to be a benefit for those using it as their assigning platform.

Video Review was indeed a challenge for us. Staff members and umpires involved spent countless hours prepping and the effort paid off during the year and continued into post season. It also proved to calm volatile situations, assisted us in getting the call right and reinforced that we’re pretty good at what we do.

I look forward to crossing paths with each of you and encourage you to pursue your umpiring goals.

Softball Umpire Program

Steve McCown

National Coordinator
steve25mccown@aol.com

Cody Little

Regional Advisor
codylittle.ok@gmail.com

Sally Walker

Regional Advisor
sewalker06@gmail.com

Joanne Venditto

Regional Advisor
jvenditto22@gmail.com

Marty Abezetic

Video Services Coordinator
National Director of Video Review
abezetic.m@gmail.com

Robbie Guest

Umpire Rep - Rules Committee
rguest408@gmail.com



Section

2

Manual Changes/Additions

2.1 New Mechanics

The SUP has approved two mechanics changes to correct breakdowns that have been happening with specific plays at third base. When U1 starts on the line and U3 chases, for runner configurations of U3 only and no runners, it is difficult for U1 to come across the infield and be in a good position for the play on the BR at third base. Typically this play results in U1 trailing the BR with a poor angle on the play or the plate umpire has come up the line and there is confusion as to which umpire has the call. These changes are designed to provide the crew more consistency and less confusion while putting the calling umpire in the best position at third base. This change will also take place in the two umpire system when U1 starts on the line and there is a triple.

U3 Point and Stay

When there is a line drive deeper down the left field line (even with or past the left fielder) that U3 takes fair/foul only on, U3 can point the ball fair and then stay at third base for a possible play on the BR. U3 needs to work their way back to the base, establish a good wedge position for the tag play and verbalize that they are there. This mechanic is never in effect for a catch/no catch, it is only foul/fair on line drives. The plate umpire needs to mirror any movement by U3 and be alert to covering third base if U3 doesn't stay or returning to home plate when U3 takes third base. U1 will read that the ball is deeper and U3 must stay longer to call fair/foul and be responsible for the BR at first and second base.

U3 Chases (MechaniGrams on Pages 104-105, 184-185 and 306-307)

When U3 chases a fly ball to make a catch/no catch decision, the plate umpire needs to move into the infield or the holding zone between third base and home plate. When the ball is caught with a runner on third, the plate umpire will read and be responsible for R3 at third base and home plate. When the ball is not caught, the plate umpire will move into the holding zone between third base and home plate. They will read the developing play and be responsible for all plays on the BR at third base and home plate. Do not commit to a calling position at third base without a pending play. When the plate umpire does commit to third base, verbalize to the crew that you are there. U1 will be responsible for the BR at first and second base. U1 will need to visually confirm that the plate umpire has moved up towards third base for any possible play on the BR.

◆ 2.2 Mechanics Changes/Updates

Home Run Mechanics

Starting in 2023 the alternate homerun mechanics have been discontinued. Over the last two seasons there have been numerous issues with crews not being on the same page, looking confused, not communicating and not covering home runs well. These lapses have made the umpires look disjointed and lost on the field. There will now be one home run mechanic that will be the full rotation of the crew. This movement allows umpires to show their crewness, communication and athleticism while working as one smooth team.

Base Umpire Starting Position on the Line

A base umpire needs to take many things into consideration when they choose their starting position when set on the line with base runner responsibilities. They have multiple responsibilities including, leaving early, illegal pitch, check swing, pick off, illegally batted ball, fair/foul and plays on batted balls.

The new specific guidance for starting position when the umpire is set on the line:

- No Runners on Base: 18-20 feet beyond the base completely in foul territory within one foot of the foul line.
- First Base with Runner On: 6-12 feet beyond the base completely in foul territory with their field side foot no farther than one foot off of the line.
- Third Base with Runner on Second: 6-12 feet beyond the base completely in foul territory with their field side foot no farther than one foot off of the line.
- Third Base with Runner on Third: 6-12 feet beyond the base completely in foul territory. Distance from the foul line up to four feet, depending on where the runner takes their lead, to see the check swing.

These starting positions allow the base umpire the best position for all of their responsibilities. The umpire will need to work hard to read a pick off play and move quickly to an unobstructed view.

◆ 2.3 In-Game Guidance

Check Swing

The plate umpire will make appeals to the open umpire when both umpires are on the line, if an umpire is rotated or counter-rotated the appeal will go to the umpire on the line. When the umpire is on the line they have set parameters and angles to gauge the swing attempt, the front hip of the batter, the front of the plate, and the bat. The umpire on the line can see clearly if the batter attempts to hit the pitch as any swing will have cleared the body and



crossed in front of the front leg. The base umpire should focus on the bat and the front hip to help in determining if the batter attempted to hit the pitch. When the umpire is on the closed side, they need to be able to see the bat. If they never see the bat then there can be no swing attempt. When they do see the bat, then they need to judge the attempt by the batter. Did the bat cross home plate, did the bat cross in front of the batter's front leg? Did the batter reach at the ball on a bunt attempt, or pull the bat back?

Collisions

Player safety continues to be paramount in our game. The rules are written to encourage runners and defensive players to avoid collisions whenever possible. If the runner is obstructed or blocked by a defender, it is still the runner's responsibility to attempt to avoid a collision. The runner must make a legitimate attempt to get to the base, and when sliding must make contact with the ground prior to reaching the defender. To prevent a deliberate collision ruling, the runner can slide, jump over the top of the defender, go around the defender or return to the previous base touched. If there is any doubt or the play happened between two umpires, get the crew together to determine any outcome.

Plays resulting in a dead ball out:

- The runner deliberately crashing into a defender with or without the ball.
- The runner attempting to dislodge the ball from the defender, including contact above the waist.

Plays not penalizing the runner:

- When the defenders actions make it impossible for the runner to avoid contact.
- When the defender deliberately crashes into the runner.

Plays with ejections:

- Any actions by a player judged flagrant/malicious.

The mechanics for this have to be clear and deliberate. If a collision occurs with the fault on the runner, raise both arms, call "Dead Ball," then point to the location where the collision occurred and rule accordingly say, "On the collision, runner's out" while giving a firm hammer. If the collision is the fault of the defender, signal obstruction, wait until the conclusion of the play to award any bases.

Fly Ball/Line Drive Coverage

Fly ball coverage is the crew working together to have the best possible look at a catch/no catch or foul/fair decision. Fly ball chasing is an individual umpire's decision to leave the infield and take responsibility from the plate umpire for the catch/no catch or foul/fair decision. Chasing fly balls is never an automatic, it is an educated choice dictated by the play on the field.



Prior to every pitch, each umpire should pre pitch their coverage area and mentally note the locations of the defenders. When a ball is hit into the outfield the umpire shall process the following information:

Is the ball in my coverage area;

Is the ball near an out of play fence/line;

Is there potential for fan interference;

Is the defender running hard towards the ball, possibly diving;

Are fielders converging;

Is the ball near the foul/fair line.

If the umpire determines that any of the above situations are happening, they commit to chasing the ball. If there is a ball that is on the border between base umpires coverage area, U1 has first right of refusal. Your movements and communication should be clear and easy for your partners to read as their responsibilities hinge on your decision. It is your responsibility to communicate clearly to your crew with your body language, verbal communication, and movement. **Do not chase balls that are clearly down, clearly out of play, or will be caught with little/ordinary effort from the fielder.**

The umpire should be set prior to the ball hitting the ground, fielders glove or wall. The distance and angle of the chase is dictated by how the play develops, work parallel to the path of the ball and move as far as you need to while the ball is in the air. If a diving catch ends up in a roll or a collision, you can continue to close distance to be sure any release of the ball is voluntary.

After you make your original chase decision, do not give up on the ball. If the play develops and needs an umpire to chase it, do not be afraid of going late and communicating with your crew, yelling your partner's first name several times. The catch/no-catch is an important call and should be chased if needed. As the non-chasing umpire you need to always be aware of what your partner is doing. Do not assume they will or won't chase a fly ball and continue to read them as the play develops in case they commit to the ball late and be prepared to adjust. When the ball is not in your coverage area you should be reading partner -> runner -> ball -> partner.

Line Drives in the Infield

All catch no catch decisions in the infield are the responsibility of the plate umpire, this includes all line drives. There are some low frequency high risk plays where the plate umpire may need help on the catch no catch and the base umpire should be prepared to assist with the call. If the plate umpire is blocked or is unable to determine catch/no catch they should not guess. They need to make eye contact with a base umpire who has an angle on the play to help them. The base umpire after delaying and making eye contact with the plate umpire can move toward the defender and make the call, then continue umpiring the rest of the play. The base umpire will not make



this call without looking at the plate umpire first, this will prevent a double call. Depending on the position of the umpire on the field and the defender, help may not be available.

In instances when the plate umpire makes a call that the base umpire is 100% certain is incorrect, they shall move towards the fielder and emphatically give the correct signal during live play to get the call right.

This play may include but is not limited to a player diving and the ball rolling out of their glove after hitting the ground or a player trapping the ball underneath them out of the view of the plate umpire.

These plays are not video reviewable with runners on base and less than 2 outs, we need to get them correct on the field in live time. Correcting this type of play after the fact will include placing runners, which we work to avoid.

This does not include plays where the infielder turns their back and dives toward the outfield. These trouble balls will continue to be covered by the base umpire's decision to chase.

Look-Back Rule (The Circle)

All umpires hold responsibility for the administration of the look-back rule. The calling umpire will verbalize and signal dead ball, step towards and point to the offending runner and call them out.

Guidance for the Batter-Runner Overrunning First Base when the Pitcher is within the Circle with Possession of the Ball

First-base umpire is responsible for the call, all umpires give help.

First Base umpire: Increase your depth to not let the runner get behind you, watch the runner return to and touch first base. Be alert to the runner leaving the baseline.

Third Base umpire: stay set and do not move to your next position until the BR has returned to first base.

Home Plate umpire: watch to see if the runner steps beyond the baseline in either foul or fair territory, committing to first or second base.

General Guidance

At the conclusion of a play, continue actively umpiring until the pitcher has possession of the ball in the pitcher's circle and all base runners have stopped on a base.

One umpire must keep eyes on the runner(s) and pitcher while the other umpires move to their next starting position. It is acceptable for the watching umpire to also move back to their position as long as they can maintain a view of the runners and the pitcher.

If time is requested by either the offense or defense before the ball is in the pitcher's control in the pitcher's circle, do not immediately grant it. Check to confirm all runners are stopped on a base, action has concluded and then grant time.

Runner's Lane

The runner's lane violation call is the primary responsibility of the plate umpire but all umpires on the field need to be looking through the play and be ready to give assistance. The plate umpire needs to be in a set position near the line, watching the batter runner run through first base. If the batter runner is out of the lane and interferes with the defender receiving the throw at first base, the plate umpire shall signal dead ball and call interference. Any time a thrown ball contacts a batter runner between home plate and first base, the plate umpire shall signal "That's Nothing" or call the interference. Note that the batter runner does not have to be hit by the ball to interfere with the defender.

The first base umpire needs to be aware of possible interference. While reading the play and being prepared to make the call at first base, they need to know the position of the defender so if there is any contact they can determine obstruction vs interference. Any additional base umpires will have a better look at where the runner is in proximity to the base when the throw hits or passes them. They can provide vital information as to whether the batter runner had or had not obtained the base prior to any potential interference.

Remember that a throw is required to call runner's lane interference, but not other types of runner interference. If interference is called on the batter-runner, all runners return to where they were at the time of the pitch. The batter-runner may run outside of the runner's lane without jeopardy of interfering if the lane hasn't been reached yet, if the runner is avoiding the defensive player fielding the batted ball, or on the last step prior to first base. **If the batter-runner never gets into the runner's lane, there is no longer protection during the last step to first base.**

For guidance with the double first base, please refer to RQ.

NOTE: The runner's lane does not protect a batter-runner from being called out for intentional interference or for interference with a batted ball.

2.4 Professionalism Update

Officials shall support and treat with respect their officiating partners, coaches and players before, during and after the contest. This includes time spent as a crew before and after the game in the locker room. The locker room is part of the umpire's workplace, it is not a gym locker room. It is an environment to discuss umpiring, mechanics, philosophy and to pre/post



game in an open and honest manner. It is also a place where all umpires deserve to feel comfortable and safe to be able to do their job. One must have an appreciation for diversity in skill, gender and ethnicity and shall not criticize partners, coaches or players in a public forum. Officials shall refrain from making disparaging statements or committing acts of prejudice. That includes making comments based upon economics, race, creed, color, age, gender, sexual orientation, physical handicap, country or national origin. Non-softball discussion topics that elicit controversy or offense should be avoided.



Section

3

Responsibilities

Umpires are expected to exhibit and uphold the highest standards of integrity. A collegiate umpire has the responsibility to base their judgment on the circumstances and facts presented regardless of an umpire's history with a team or player.

A collegiate umpire continuously seeks self-improvement through the study of the game, rules, mechanics and game management. Umpires use established and approved signals and mechanics. Collegiate umpires must have a complete understanding of the rules, their intent and purpose and the ability to interpret and enforce these rules and principles.

Umpires are expected to:

- Enforce the NCAA softball rules as interpreted by the NCAA Softball Rules Committee and the Secretary Rules Editor.
- Possess an overriding sense of reason, justice and integrity.
- Render decisions promptly, confidently and with integrity.
- Conduct all business in a courteous and professional manner.

In addition to administering the game according to the NCAA Softball Rules and rendering decisions based on the actions in accordance with rules, umpires are expected to be a model for fair play.

Umpires must:

- Ensure that every student-athlete has a reasonable opportunity to perform to the best of their ability.
- End any situation that threatens the safety of a student-athlete.
- Maintain a healthy environment for competition.
- Never allow intimidation by word or action toward a student-athlete, coach or umpire.
- Resolve conflicts with dignity and respect.



◆ 3.1 Preparation

Preparation for a game assignment begins in your pre-season. All umpires on every level need to make a commitment to work on improving all facets of their game.

- **Rules and mechanics:** Every umpire should review and study the current NCAA Rules and Case Books along with the CCA manual. Knowing the intent and spirit of the rule can help when dealing with plays that may fall into a gray area.
- **Physical fitness:** All umpires should be physically fit in order to keep pace with the players and the game.
- **Schedules:** Umpires are responsible for keeping all assigning platforms updated with current availability and you should honor all accepted assignments from your coordinators.
- **Uniform:** You only get one chance to make a good first impression. Take pride in your appearance, it sends a strong message of who you are and your attention to detail.

Sometimes the mental part of umpiring is the most difficult. An umpire can acquire the mechanical skills, perfect the timing and be able to recite the rules verbatim, but the mental aspects can be most elusive. Commit to improving your mental performance as much as your physical, research and engage in mental performance training, work on your conflict resolution skills and refine your focus.

The CCA manual's diagrams guide us to positions where we can read the play to make adjustments to see and make a call. Umpires must adapt to where the ball is, where the fielders are and where the runner might be — adjust and move to have the best possible look at a call.

If you know the theory and keep the four elements in front of you, ball, defensive player, base and offensive player, you will be in a good position to make the call.

◆ 3.2 Expectations

A governing sports committee or games committee shall ensure officials adhere to the NCAA's policies related to gambling activities, drug and alcohol use. Furthermore, officials must conduct themselves in a manner befitting intercollegiate athletics. Failure to do so may result in termination of the officiating assignment.



Never bring attention to yourselves by announcing to people who you are and why you are in town. Umpires are adults and should know these things, but experience mandates these policies. Umpires are visible and recognizable to the media, coaches, student-athletes and fans.

Code of Conduct for Sports Officials

1. Officials shall bear a great responsibility for engendering public confidence in sports.
2. Officials shall be free of obligation to any interest other than the impartial and fair judging of sports competitions.
3. Officials shall hold and maintain the basic tenets of officiating, which include history, integrity, neutrality, respect, sensitivity, professionalism, discretion and tactfulness.
4. Officials shall master both rules of the game and mechanics necessary to enforce the rules, and shall exercise authority in an impartial, firm and controlled manner.
5. Officials shall uphold the honor and dignity of the profession in all interactions with student-athletes, coaches, school administrators, colleagues and the public.
6. Officials shall display and execute superior communication skills, both verbal and non-verbal.
7. Officials shall recognize that anything, which may lead to a conflict of interest, either real or apparent, must be avoided. Gifts, favors, special treatment, privileges, employment or a personal relationship with a school or team, which can compromise the perceived impartiality of officiating, must be avoided.
8. Officials shall prepare themselves both physically and mentally, shall dress neatly and appropriately, and shall comport themselves in a manner consistent with the high standards of the profession.
9. Officials shall not be party to actions designed to unfairly limit or restrain access to officiating, officiating assignments or to association membership. This includes selection for positions of leadership based upon economic factors, race, creed, color, age, sex, physical handicap, country or national origin.
10. Officials shall be punctual and professional in the fulfillment of all contractual obligations.



11. Officials shall work with each other and their governing bodies in a constructive and cooperative manner.
12. Officials shall resist every temptation and outside pressure to use one's position as an official to benefit oneself.
13. Officials shall never participate in any form of illegal gambling on sports contest, may never gamble on any sporting event in which they have either a direct or indirect involvement and may never gamble on events involving high school athletics.
14. Officials shall not make false or misleading statements regarding their qualifications, rating, credentials, experience, training or competence.
15. Officials shall accept responsibility for all actions taken.

Copyright© 2006, Officiating Development Alliance (ODA)

◆ 3.3 Social Media Guidelines

The SUP wants every umpire to enjoy the experience of working NCAA Softball; however, we must be aware of the perception that can be created by inappropriate posts using social media.

- Consider social media communications as public at all times — even if created with private intentions. If you are going to use social media in any form, consider your communication may be read by anyone at anytime.
- You represent the officiating industry, your associations, your assigners and your partners. Act accordingly.
- Promote officiating in a positive light and with a general feeling of pride and professionalism. You are an ambassador for officiating.
- You have a unique access to information. The same ethical restrictions that apply to any form of public speech also apply to social media. It is inappropriate to communicate specifics about your assignments, other officials, conferences/schools, coaches, players or any related personnel.
- Do not engage in specific play and or ruling evaluation/commentary, whether it is of a game you worked, one that you witnessed or in general about the impact of officials in any sporting event.
- Communications among officials for learning purposes should be done privately and not through the use of social media. Be mindful that email and other forms of direct communication can be made public.
- Be very sparing in the sharing of your personal information, including photos. Adjust security settings accordingly. Report fake profiles or posts to the appropriate authorities/governing bodies in a timely fashion.



- Follow specific conference, school and/or governing body social media policies.

— NASO Board of Directors

Officials are asked not to make any public statements about Conference or NCAA officiating duties, about the officiating (whether by the official or another person) of any contest involving a member institution, about the contest itself, or about any of the institutions, coaches, or players involved.

3.4 Policies

Affiliation/Conflict of Interest

- Officials shall not have an affiliation with any parties in the contest. Without equivocation, game decisions must be free from perceived or actual personal bias.
- The NCAA will request information regarding any affiliations during website registration and expects all officials to divulge any and all affiliations with member institutions and conferences (and others as requested) when asked to be considered to work postseason contests.
- Officials must recognize that anything that may lead to a conflict of interest, either real or perceived, must be avoided. Any privileges, employment or personal relationships with an institution, team/team member or conference that can compromise the perceived impartiality of officiating must be avoided.
- Officials shall communicate with all of their coordinators/assigners about any conflicts of interest or affiliations.

Tobacco

The use of tobacco products by umpires at the site of competition (e.g., umpires' locker room, playing field, other areas of the stadium) is prohibited.

Alcohol

Alcoholic beverages of any type are not permitted in the umpire locker room. After an umpire has completed the days assignment(s) (including serving as an alternate), drinking alcoholic beverages is allowed. However, a few guidelines should be adhered to:

- Never drink at the stadium or field.
- Never drink in any public place at the hotel if teams are staying there. Find a reputable establishment that is not frequented by the media, coaches or student-athletes.
- When you are in an establishment and members of the media, coaches or student-athletes arrive, you should finish your drink and leave.
- Adhere to a two-drink limit.
- Never under any circumstances, drive an automobile after having consumed alcohol.



Gambling

The NCAA opposes all forms of legal and illegal sports wagering. Sports wagering has the potential to undermine the integrity of sports contests and jeopardizes the welfare of student-athletes and the intercollegiate athletics community. Sports wagering demeans the competition and competitors alike by sending a message that is contrary to the purposes and meaning of “sport.” Sports competition should be appreciated for the inherent benefits related to participation of student-athletes, coaches, and institutions in fair contests, not the amount wagered on the outcome of the competition. For those reasons, the NCAA membership has adopted specific rules prohibiting athletics department staff members and student-athletes from engaging in gambling activities as they relate to intercollegiate or Professional sporting events. NCAA softball umpires should adhere to the following guidelines:

- Never ever bet on a game — with anyone. Various tactics will be used by gamblers to encourage your involvement.
- Never associate with known or suspected bettors.
- Never offer any opinions about any game to anyone — before or after the game.
- Never put yourself in a compromising position through any personal misconduct.
- Never accept favors or gifts from suspected or known bettors.
- Never furnish any information about a game, student-athletes, coaches, or officials to anyone except when following your conference’s procedures.
- Never hesitate to discuss any suspicious person(s) with your supervisor, who will notify investigative authorities. If necessary, a confidential investigation can be conducted.

Always inform your supervisor and law enforcement officials anytime an individual suggests (even apparently in fun) that you accept money to affect the outcome of a game. Gambling is not only big business — it is dangerous business. Your cooperation in the fight to combat it will not only protect intercollegiate competition from its harmful influences, but also will place one of your most important aspects — your personal integrity — above reproach.

The Softball Umpire Program and the NCAA are very concerned about the perception of its umpires and gambling. Any local area casino, racetrack or other establishment where any form of wagering occurs is strictly off limits at all times while working or traveling to work games involving NCAA teams. No exceptions or allowances will be given in this area.



◆ 3.5 Uniform and Equipment

Beginning with the 2021-2022 season, there are two uniform options— a standard uniform (Uniform 1) and an alternate uniform (Uniform 2). Uniform 1 is the uniform required by the SUP for postseason play. The umpiring crew shall be dressed alike. Conferences or associations may dictate what uniform(s) may be worn during conference and non-conference play.

Uniform 1 (Standard/Post Season Uniform):

- A plain navy blue fitted cap,
- A blue short-sleeve pullover shirt (with a collar, contrasting button placket and dark navy/white insert on the sides beginning under the arms), or a dark navy short-sleeve pullover shirt (with a collar, contrasting button placket and blue/white insert on the sides beginning under the arms),
- Navy undershirt,
- Non-pleated dark gray pants,
- Navy blue ball bag,
- Black belt with silver buckle, no patent leather,
- All black socks and shoes, no patent leather,
- A dark navy blue umpire jacket with blue accents on the shoulders and back (short or long sleeves).

Uniform 2 (Alternate Uniform):

- A plain navy blue fitted cap,
- A powder blue short-sleeve pullover shirt (with a collar, button placket and navy, powder blue and white trim on the collar and sleeves), or a navy blue short-sleeve pullover shirt (with a collar, button placket and red, navy and white trim on the collar and sleeves),
- Navy or white undershirt,
- Non-pleated navy blue pants or non-pleated heather grey pants,
- Navy blue or heather grey ball bag,
- Black belt with silver buckle, no patent leather,
- All black socks and shoes, no patent leather,
- A plain navy blue umpire jacket with powder piping (short or long sleeves).
- Pink shirts (with a collar, button placket), may be worn when honoring “Breast Cancer Awareness Day.”

All umpires must wear the same color shirt, but individual umpires may wear a short or long sleeve shirt. Individual umpires may choose not to wear a jacket, wear a jacket with full sleeves, or wear a jacket with short sleeves. If a jacket is worn it must be zipped 3/4 of the way up and it is not to be tucked in the pants.

Conference affiliation may be embroidered on caps for use in conference play only. Shirts and jackets should be plain for both conference and non-conference play.



“NCAA” may be embroidered on caps and approved NCAA logos and marks may be embroidered on shirts and /or jackets for use in NCAA postseason play only.

A 3-by-2 inch patch of the American flag may be sewn with its bottom edge on the hem of the uniform shirt's left sleeve.

Equipment

- Mask — Non-reflective black frame, all-black harness, black or black and tan pads (with the tan next to the umpire’s face), and, if one is attached, an all-black throat protector. If the helmet style mask is worn, it must be black and a hat (worn correctly) must be worn under the helmet. **All visible logos must be blacked out.**
- Ball/strike indicators must be used on plate and base.
- Black bristled brush.
- Navy blue ball bag(s) with no insignias or logos. One or two ball bags may be worn.
- Pen or pencil.

Optional Equipment

- Line-up cardholder.
- Chest protector; exposed parts navy or black with as little advertising as possible. **All visible logos must be blacked out.**
- Shin guards; exposed parts must be navy or black. **All visible logos must be blacked out.**
- Sunglasses should be non-mirrored with dark or clear lens with all black frames (G-30 are approved if non-mirrored).
- When a strap is used it must be black and hold the glasses tight to the head.

Jewelry

Acceptable:

- Small discreet stud earrings, no more than one per-ear.
- Small tight-to-the-ear loop earrings.
- One necklace that must be, and remain at all times, tucked in the uniform shirt.
- Wedding bands and religious or medical jewelry.

Not acceptable:

- Wristwatch.
- Any type of bracelet.
- Anything that dangles, sparkles, or draws attention.
- Choker style necklaces.



Section 4 Pregame Administration

4.1 Before the Game

Each conference may have a predetermined contact date for the crew chiefs to contact their crews and/or game management staff. If not, it is advised you contact your crew a minimum of one week before the game day.

Crew Chief

- Contact your crew and the on-site administrator to confirm the date, time and location of your assignment.
- Agree to a pregame meeting location and time.
- Discuss flight, rental car and/or hotel arrangements, if necessary.

Game Day

- Crew arrives at pre-arranged site at least one hour before game time.
- Dress in professional attire when traveling to the game, between games and when in a softball environment.
- Crew chief reports to on-site administrator.
- Crew turns off cell phones.
- Crew checks the field and determines ground rules.
- First game plate umpire leads pregame discussion with partners.
- Crew arrives at the field fully dressed approximately 20 minutes before game time.
- Crew performs bat inspection.
- Confirms game balls and rotation method.

Pregame Topics with Partners

- New rules and rule interpretations
- New mechanics and points of emphasis
- Unusual situations and mechanics
- Run rule
- Tiebreaker
- Halted game
- Drop-dead time
- Weather conditions
- Fly ball chasing
- Fair/foul coverage
- Leadoff responsibilities
- Tag up responsibilities
- Check swings
- Between play coverage



- Fairly common situations (obstruction, etc.) and mechanics
- Illegal pitches, hit by pitch, hit by batted ball
- Any pertinent history with the crew members and teams
- Warnings — required: record
- Going for help/Providing additional information to the calling umpire — how, when, when required
- Umpire huddles — when, how to conduct
- Umpire verbal and non-verbal communication
- Confrontations and role of non-involved umpires
- Ejections
- Exiting the field

Pregame with Coaches

- Introductions
- Home team lineup, visiting team lineup, substitution procedures
- Ground rules
- Halted game and drop dead time
- Conference/special rules
- Questions
- Play ball

◆ 4.2 Equipment Check

Institutions are responsible for ensuring that the equipment used in competition meets the prescribed industry standards of safety and legality. Coaches are responsible for ensuring that players are legally equipped and properly attired. If an umpire notices equipment that is defective or illegal or unsafe, it should be brought to the attention of the head coach and acted on according to the rules.

Bat Protocol

Softball barrel compression testing is required to be conducted according to accepted protocols at a minimum prior to the start of each tournament, series, doubleheader, or single game during the regular season. In the pregame meeting with the crew, review the bat protocol and the steps to follow for inspecting the bats. Upon entering the field, ask the coaches to provide all bats for inspection that are intended to be used during the game if they are not out. This includes all bats on the field and in the dugout. Any bat NOT tested may not be in the dugout – even in the equipment bag.

Coaches shall provide their team's copy of the current NCAA Approved Softball Bat List. The list should have the following information recorded before the umpires check the bats: team name, date and game time, BCT testing manager name and initials, sticker color, and total number of passed bats. Teams are to also highlight and record a count of each make and model of bat that is available to be used in the game.

Before each game, the umpires shall reconcile the total number of appropriately stickered bats with the number of bats indicated on the team's BCT annotated NCAA Approved Softball Bat List, making sure the number of stickered bats does not exceed the number of bats listed as having been tested. Also before each game, the umpires shall inspect the bats for suitability and any obvious damage.

In addition to softball bats on the current NCAA Approved Bat List, fungo bats and non-altered, one-piece wooden baseball or softball bats may be used in pregame warm-ups and may be in the on-deck circle.

In conferences where teams are playing a double-header or multiple games in a day, bats must be inspected at the beginning of each game. Umpires should make every attempt to return to the field in a timely manner, especially in areas where games could be hindered by darkness. Bat check should not be negated.

Bats deemed inappropriate or damaged by the umpires shall be removed from the team's possession and secured by the on-site administrator for the duration of the game, doubleheader, series or tournament, and the team's NCAA Approved Softball Bat List appropriately edited.

Bat Inspection:

Listed on RQ, umpires are able to view the current bat inspection procedures.



Section General Game Information

5.1 Game Management

Good game management and attention to detail are ways to prevent unexpected things from happening in the game. Beyond rendering decisions, it is the manner in which you approach all of the other situations that may occur in a game. Umpires need to listen and address all game participants and/or issues in a professional manner.

Game administration: Establish and maintain an appropriate game pace. Administer all timing rules as written in the rules book. When asked a question by a coach, listen to the question and respond to it in a respectful manner.

Sportsmanship: It is important that we have a clear understanding of the expectations for good sportsmanship. If a coach or any game personnel exhibits poor sportsmanship it is your responsibility to address the issue. If the behavior warrants a warning, then it is your responsibility to issue the warning and to make certain the crew is aware when and why a warning is issued. If there is an ejection, follow the protocol in the rules book and manual.

On the field: Partner communication is extremely important. Use umpire-to-umpire signals, verbal and non-verbal communication to convey information to all members of your crew. Work as a team and communicate with each other. Know your responsibilities as well as your partner(s).

Hustle: An umpires movement on the field at all times should be brisk, purposeful, educated and appropriate. Move to your next position by choosing the most efficient path to achieve an optimum position for all possible situations. However, don't move for the sake of moving if you are already in the right position.

Line-up cards: Good line-up card management begins at the pre-game conference with the coaches when you verify the cards. When a change occurs in the line-up, confirm the change before giving it to the opposing coach and the scorekeeper. This will alleviate possible line-up change protests. Take your time. It is recommended that you do not cross out the names of any player not present on game day. If the game is halted and the player on the line-up card is available, they are eligible to play when the halted game is resumed. Before you stop play for a change, look to make sure that the pitcher has the ball in the pitcher's circle and then call "time" to accept the change.

Listed on the Central Hub (main page, under general umpiring information, players and substitutions — rule 8) umpires are able to view the lineup card management system.

◆ 5.2 Replay Procedures

Crews are encouraged to use replay as an asset. Replay will allow correction of clear mistakes and will lead to improved sportsmanship on the field and better training for officials. Specific replay protocols will be published in a separate document on Ref Quest. General guidelines include one umpire remaining on the field, monitoring team members. The remaining umpire(s) including the crew chief reviews the play then the crew chief (or plate umpire) gives the final replay decision. Coaches are not allowed to argue replay decisions.

◆ 5.3 General Guidance for Handling Player Altercations — Early Intervention

Umpires should be alert to warning signs and situations that could lead to player-to-player altercations. Not all situations require intervention; however, a crew with good game management skills will be aware of opportunities to be involved and potentially avoid fights or brawls. Here are some examples of early intervention.

Hit by Pitch: On every hit by pitch, move forward a step or two and observe the body language of the batter. If you detect frustration, take a few steps towards first base in fair territory keeping yourself between the batter and the pitcher.

Raising Elbows or Nearly Stepping on Fielders: Be prepared if a player raises an elbow (but doesn't make contact) or steps hard near the foot or leg of an opponent. These situations do not always require a formal warning but should be addressed by the umpire. A simple statement to the player, "I'm watching your elbow" or "I'm watching your feet" may be sufficient.

Players Jawing at Each Other: Players will make comments to other players. Umpires should only intervene if they determine that it is affecting the game, unsporting, inciting, or will lead to further problems.

Unsporting Behavior: If a comment or action is worthy of a warning or ejection, issue it immediately before it becomes a fight. If an altercation starts too quickly, wait until it is over before issuing warnings or ejections.

Physical Altercations

Never touch or restrain players. The closest umpire should attempt to stand between them if there is sufficient space, otherwise stand on the perimeter. The



other umpire(s) are responsible for monitoring team areas and not allowing other players to join. Use firm visible and verbal gestures such as holding palms out (stop sign) and saying “Stop! Go back to your dugout/position.” Allow coaches and game administration to assist in restoring order.

Do not eject player(s) until calm has been restored, and the crew has been able to confer with each other how to handle it per Rule 13. This includes:

- Identifying the players who will be ejected for the start of the altercation,
- Identifying all personnel who left their team areas, defensive position, or bases to join the brawl.

Handling Multi-Coach Arguments

Umpire coach arguments or discussions should always be completed one on one. If multiple coaches approach an umpire for a discussion that umpire should inform the coaches that they will only talk to one of them. Do not engage in the discussion until only one coach is present.

If you are not the umpire directly in the argument you need to help in removing any additional coaches from the discussion. Engage the coach not in the argument and walk them away from the discussion working to talk them down. Prevent other coaches from joining an argument. Do not follow coaches if they are leaving the argument.

5.4 Warnings

The NCAA would like more consistency in administering warnings across all levels of softball. A warning is a statement of fact: a warning is not a threat. For unsportsmanlike behavior, the warning is a courtesy given by the umpire, but is not required before taking action as some behavior warrants an ejection. When a warning is issued, action must be taken on the next occurrence. Some rule infractions stipulate that a warning has to be issued before stronger action is taken. Some rule infractions do not need a warning to be given prior to removal from the game. Some rule infractions mandate that a warning be given leaving the umpire no choice or discretion. The following is a list of incidents that require a warning from the umpire. Be aware of which warnings are team vs individual and the result of a second offense.

Individual Warnings

- Illegal equipment, inappropriate warm-up bats, or non-compliance with uniform rules.
- A player not wearing a facemask to take warm-up pitches on the field of play.
- Use of illegal electronic equipment (head coach is also warned).
- Violation of offensive warm-up requirements and allowing uniformed team members near or behind home plate or the backstop during live or warmup pitches.
- Defensive team personnel, except the nine defensive players on the field, not remaining in the dugout, bullpen or team area while the ball is in play.

- Violation of defensive warm-up requirements (head coach is also warned).
- For the following types of obstruction (head coach is also notified): rounding, leading off or returning, pushing a runner off a base, batter or base runner vision obstruction.
- Applying moisture or any substance to the ball or into a glove that will then contact the ball or doing anything else to deface the ball.
- A catcher not returning the ball directly to the pitcher after a foul tip and each pitch not contacted (with exceptions).
- Intentionally violating the time allowed between pitches in order to walk the batter without pitching.
- Deliberately throwing or kicking a piece of equipment as a result of disgust or frustration.
- A base runner intentionally distracting or running at any fielder in an effort to distract them while not making an attempt to run directly to the base. This pertains to any defensive player regardless if the defensive player is the one making a play on the ball.

Team/Head Coach Warnings

- Intentionally removing or covering any lines or plates.
- Use of artificial noisemakers or equipment to make noise.
- Offensive team not keeping all personnel, except base coaches, batter, base runner(s) and on-deck batter, in the dugout, bullpen or dead-ball area while the ball is live.
- Defensive and offensive teams not keeping all personnel in the dugout during stoppages of play during the inning, including during conferences, pitching changes, substitutions, and injuries, except for those players directly involved in the situation.
- Huddling after an out.
- Committing any act (e.g., “Time” or any similar word or phrase, holding up a hand, stepping out of the batter’s box) while the ball is live and in play for the obvious purpose of trying to make the pitcher deliver an illegal pitch.
- Intentionally attempting to hit the batter with a pitch (pitcher, catcher, and head coach warned).
- A player other than the pitcher of record throwing a warmup pitch (head coach is warned).
- Throwing a bat into fair or foul territory, and it has the potential to endanger anyone who is not making a play on the ball.
- Offensive team personnel interfering with a runner(s) who is legally running the bases on a dead-ball award until the runner(s) contacts home plate, or interfering with the umpire’s ability to see that all bases are properly touched.
- A runner sliding out of the base line at a defender (if the play isn’t egregious enough for an automatic ejection).
- Using equipment in any way other than what is intended by the manufacturer (head coach is warned).
- Verbal misconduct (using profanity or vulgarity toward, baiting, making insulting or disparaging remarks to or about, or otherwise taunting an opponent or umpire; questioning the integrity of an umpire).



- Questioning the strike zone and any call based purely on umpire's judgment.
- Inciting or attempting to incite, by word or sign, a demonstration by spectators (e.g., reenacting the play, charging the umpire in a hostile and aggressive manner, jumping around or waving arms in disgust).

The umpire shall remain calm while issuing the warning, and explain what the warning is for. The head coach shall be notified of any warnings given to their team. It is imperative that certain information is recorded on the plate umpire's lineup card: the inning, the individual, and the circumstances of the warning. Umpires shall inform their partners when a warning has been issued.

◆ 5.5 Behavioral and Administrative Ejections

Behavioral Ejections

Umpires are empowered to remove any participant for unsporting behavior or verbal misconduct, a responsibility that should never be taken lightly. The NCAA recognizes that every situation is unique and that umpire discretion is essential to proper game management. Student-athletes and coaches look to umpires for uniformity in applying standards to determine grounds for ejection.

Umpires will inform the coach when the ejection is subject to a possible games suspension. (See Rule 13 Misconduct)

The following general principles should be considered when deciding whether to eject a player, coach or team member from a game:

- Was there use of profanity directed at an umpire?
- Was there an accusation of bias or cheating?
- Was there physical contact with an umpire?
- Was there refusal to stop arguing that led to delaying the game after an umpire had provided a player or coach adequate opportunity to make a point?
- The umpire should warn the player or coach that they were heard.
- Was someone questioning the strike zone after being warned?
- Was there use of gestures, (for example, jumping up and down, drawing on the ground, or violently waving arms) while arguing with an umpire?
- Did someone make gestures toward an umpire to incite the crowd?
- Did someone throw equipment or other items while arguing?
- Was there fighting?
- Did anyone leave the dugout to join a brawl?
- Was there an unsporting act that is defined by rule?
- Was the pitch intentionally aimed at a batter or umpire?
- Did a coach argue the final decision from a video replay?

Umpires have the authority to issue a pregame or postgame ejection for unsporting behavior that occurs after the umpires arrive on-site but prior to the first pitch or after the last out of the game and before the umpires have left the site. If the conduct would have resulted in an ejection had it occurred during the game, the behavior deserves the same attention and consequences before or after the contest.

Administrative Ejections

An administrative ejection is given for a rule violation regarding equipment, line-up card management, excessive conferences and warm-up activities. See Rule 13 Misconduct.

5.6 Managing Ejections

Umpires must present a united front in the event of an ejection. Members of the crew as well as the players and fans, need to know when there has been an ejection. Be alert when an umpire is having a discussion or any time a coach approaches another umpire.

Process:

- Once an umpire ejects a coach, player or team member, that umpire should move away from the ejected person.
- One of the other umpires must step in and help to defuse the situation by talking calmly and guiding the ejected person (without touching them) off the field.
- The umpire who is walking the ejected person off the field should instruct them where they may remain for the rest of the game.
- If the head coach is the ejected individual, a new acting head coach will need to be designated prior to the game continuing.
- The non-ejecting umpire may be required, if warranted to inform the remaining coach and game management that by rule the offending coach has one minute to leave the game or the game can be subject to forfeit.
- In a three or four person system, the remaining umpire(s) is/are to monitor team dugouts to ensure that personnel do not leave the dugout area.
- Do not resume the game until the ejected person has left the facility or is in the designated area.

Finally, once the coach or player has left the facility or is in a required area, the umpires should meet to record the pertinent information around the ejection, assess the game situation and award any penalties or base awards.

At the end of the game, the umpires should discuss the ejection and contribute to the written incident report. The ejecting umpire is responsible for submitting the incident report (located under the Forms tab on the Central Hub Home Plate) to the softball secretary-rules editor as soon as



possible but no later than 24 hours after the game. **If the ejection carries a game suspension, the ejecting umpire must call the secretary-rules editor at the conclusion of the game.**

◆ 5.7 Protests – Regular Season:

Protests May Involve

- The failure to apply the correct rule to a situation.
- The failure to impose the correct effect for a given violation.
- The misapplication of a playing rule.
- The misapplication of a playing rule combined with a judgment call.

Protests May Not Involve Judgment Only

When faced with a protest that involves only umpire's judgment, the umpire should first attempt to explain the rule or reason for the disputed call to the protesting coach. If that does not produce a resolution, the umpire should verify the explanation with the umpiring crew and reiterate it to the coach or, if the umpire was in error, correct the situation. If resolution still cannot be reached, even if the umpiring crew is positive of the ruling, one coach of each team should be brought together and be allowed to give input while the umpire crew attempts to settle the dispute using the rulebook. If the protest cannot be settled to the satisfaction of the protesting coach, the coach may continue the game under protest by notifying the plate umpire of the intent to protest before the next pitch.

If the game ends (legal contest) and there is a possibility of a protest, the offended team has one minute to voice its protest intentions.

If the Game is Continued Under Protest:

1. The plate umpire must announce to the opposing coach, both team's scorekeepers, the official scorer and the public-address announcer that the game will be resumed under protest.
2. The plate umpire and the protesting coach must note and record the relevant information including:
 - a. The opponent, date, time and place of the game.
 - b. The names and phone numbers or email addresses of the umpires and the official scorers.
 - c. The rule references, or the ground rule under which the protest is being made.
 - d. The essential facts, details and conditions pertinent to the protested decision.
3. As soon as possible after the conclusion of the game the plate umpire is to notify the NCAA secretary-rules editor of the protest.

Within 24 hours, the plate umpire and the protesting coach must each complete an official protest form (located under the forms tab on the Central



Hub Home Plate) and send it to the secretary-rules editor. The opposing coach may also choose to complete and send the official protest form to the secretary-rules editor.

5.8 Forfeits

A forfeit is a no win situation for umpires and teams alike. When considering how to handle a difficult situation, a forfeit should not be considered as a viable option. Umpires should use every means available to them before declaring a game a forfeit. However, if incidents occur that by rule mandate the game be forfeited, then umpires must have the courage to enforce the rule.

Umpires must concur in order to declare a game forfeited. A forfeit of a contest cannot occur until the umpire has assumed jurisdiction of the contest. The score of a forfeited game shall be 7-0 in favor of the team not at fault unless the game is regulation. The score and all game stats shall stand and be credited as played if the offended team is ahead at the time of the forfeit.

The plate umpire is responsible for submitting an incident report (located under the forms tab on the Central Hub Home Plate) to the softball secretary-rules editor as soon as possible but no later than 24 hours after the game.

5.9 Submitting Report

The NCAA Softball Incident Report is used for all reports.

- Any bat that fails inspection.
- Ejection.
- Protest.
- Forfeit.

When a Report Must Be Submitted

- As soon as possible. **If the incident requires a suspension, umpires must call the secretary-rules editor at the conclusion of the game.**
- No later than 24 hours.

Who Receives the Report?

- NCAA secretary-rules editor.
- Optional: Umpires conference coordinator or assigner, if requested.
- It is good practice for the umpire to keep a copy of the report.

Who Writes the Report?

The plate umpire will complete all forms concerning protests, forfeits and all bats that do not pass field inspection. For ejections the ejecting umpire shall file the report.



Following the incident the plate umpire should write down the details of the ejection: name, number, inning, score, situation and briefly what happened. After the game the crew should review the incident to ensure the correct information is documented and all agree what occurred.

Content of the Report

- Record the inning, outs, score and situation at the time of the incident.
- Document (if an ejection): ejected person's name, uniform number and institution name.
- What was the rule violation: arguing balls and/or strikes, misconduct, physical contact?
- What caused the incident?
- What events led up to it?
- Was there a previous warning?
- Was there earlier discussions or arguments?
- What happened after the ejection?
- Were there any comments directed at an umpire after the ejection?
- Which crewmember escorted the ejected individual person off the field?
- Were there any further incidents?
- List the manufacturer, model, model name and reason for each bat that failed inspection.

Guidelines for Writing Reports

- Stick to the facts; avoid opinion as the report has potential to be used as a legal document.
- Give details; quote exactly even if the language is offensive.
- Do not reference incidents from previous games.
- Do not make recommendations as to what should happen.
- Do not use softball vernacular; use correct terminology.
- Use correct spelling, proper grammar and avoid punctuation errors.



Section

6

In Game Umpiring/Situations

◆ 6.1 Crewness

Crewness is the essential and fundamental ability of the umpire team to work together to serve the game of softball. Crewness requires planning, communication, game management tools, the ability to learn from others, leadership and hard work.

The umpire crew needs to be on the same page. All umpires should have written and shared the goals that they are currently working on with the crew. Each umpire must put their personal agenda and opinions aside as the crew works together. Professionalism takes precedence and is the basis for building respect, integrity and taking responsibility for shortcomings.

Communication before, during and after the game is essential for building a high performing crew. The umpires that use approved mechanics, signals and verbal communication build trust and credibility with the crew. The crew understands and uses proper, proven and appropriate management tools in providing a climate of good game flow and sportsmanship.

The game deserves a good reflective post game. Celebrate the things the crew did well. Revisit goals and lapses of focus should be shared. An honest accounting of personal and crew performance should be noted. Questions and suggestions should be offered rather than accusing statements. Together we can learn from each other, solve problems and be better tomorrow. A crew is not about you or me, but WE, trying to achieve the big picture goal of getting the call right for the student athletes.

◆ 6.2 The Value of Verbal

Verbal communication is equally as important as crisp signals and mechanics. Appropriate tone, volume, and inflection when verbalizing a call can effectively sell it while preventing questions and misunderstanding. A succinct piece of information used at the right moment can enhance the confidence others have in you. Similarly, verbal communication with partners strengthens the bonds with a crew, increases the comfort level, and conveys to the participants that umpires, too, are working as a team. Consider phrases that are easily understood by your crew and participants during playing action. For example: "I've got the tag up," "I'm going home," "That's obstruction," "I've got third," "That's nothing," "No tag," "No control," and "Off the bag."



When communicating with your partners on the field, use their first names. Often, simply using your partner's first name conveys complete information. When an umpire hears their name spoken during a play, it triggers them to recognize and respond to the situation. Ongoing partner communication throughout the game can prevent small mix-ups and huge catastrophes.

At all levels of play, the interactions that umpires have with coaches can greatly affect the flow and tone of the game. Good communication includes critically listening to a coach before explaining your decision. Umpires must seek a balance between talking too much and not enough. Be succinct in explaining what your call is and what you saw. Once you have answered the coach's questions, return to playing the game, don't let conversations run too long. Bad communication includes seeking out conversations with coaches or players that are not important to the game. Be cordial and professional, but don't assume a level of friendship that's not appropriate during the game.

The NCAA Softball Umpire Program advocates using professional titles and last names when interacting with coaches. While it is acceptable to simply say "Coach" when communicating with the team staff, it is more effective to use "Coach [last name]." Coaches will often call you by your first name, and that is okay; however, you should refrain from using their first name in a game setting.

6.3 Strike Zone

Strike zone accuracy cannot be emphasized too strongly, every umpire at every game of every division needs to adhere to the strike zone that is described in the current rulebook. The strike zone is the area above home plate between the bottom of the batter's sternum and 3.82" below the top of the knee when the batter assumes their natural batting stance. The ball must be pitched through the dotted line box, without bouncing (see PlayPic page 40) to be called a strike.

The two diagrams are excellent guides to call an accurate zone. The first diagram details the view of the strike zone from above home plate, and the second one details the strike zone from the front of home plate. If the pitch is over any part of the plane of home plate and meets the height criteria, it is a strike. Remember, the position of the batter in the box (front or back) does not change the height criteria — it is the natural stance at the plate.

Umpires must be accurate. The plate is constant, vertical is variable, call the complete zone for every batter. Umpire's head height may be adjusted for each batter or may be constant choose the position that allows you to see through the entire strike zone.

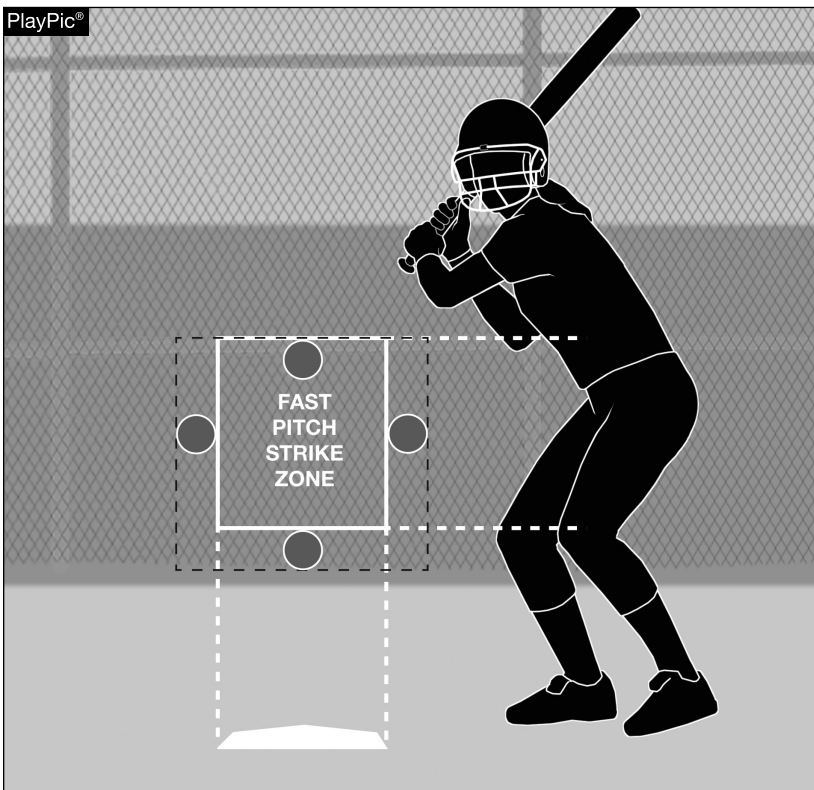
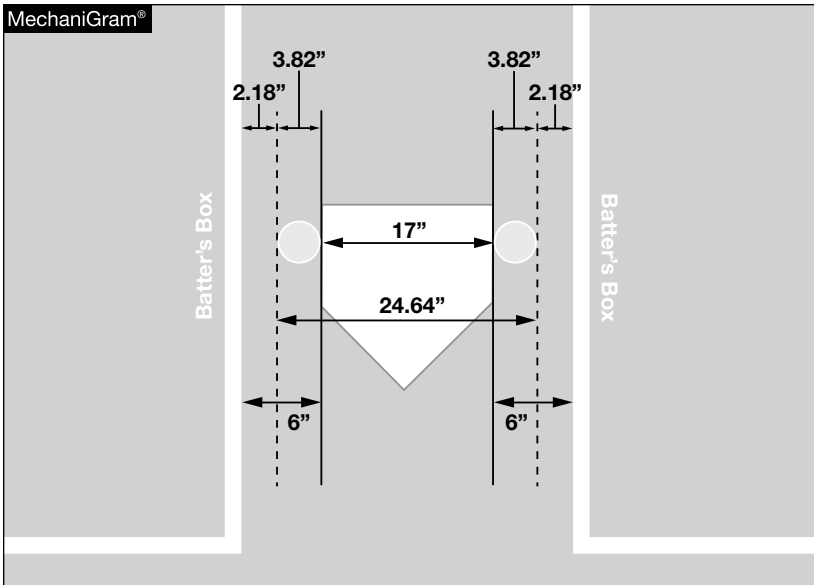

You need to be in the slot looking through the strike zone while adjusting your stance to see the outside corner of the plate. Track the pitch using only slight head movement; do not indicate the location of the pitch with your body. You need to be set when the pitch is released. It is not possible to see all things at all times so we need to prioritize the location of the pitch. Do not give up on the location of the pitch in order to be perfect on checked swings, the location of the batter's feet, or whether or not the pitcher is outside of the 24". If the pitch is in the strike zone, disregard the check swing and call the pitch. It is your responsibility to call an accurate strike zone. Players and coaches need to know that umpires are accurate from the first pitch till the last pitch of every game.

◆ 6.4 Option Plays

Some rule situations have effects which require teams to choose between various options. With the increase of plays resulting in delayed dead ball rulings, we will see an increase of option plays. Administering option plays can get complicated. Please see below for guidance and examples of correct administration. If necessary, get the crew together before presenting the options to make sure you are correct.

Single Option Play - At the completion of the play, approach the head coach of the offended team and present the options. **Once the team has chosen and the effect administered, the team cannot change its decision.** Do not assume what the offended team will select. Allow them to choose.

Example Play: R1 only. 1-1 count. 1 out. The runner leaves early as the pitcher throws a strike. The catcher throws out R1 at second base.
Procedure: At the end of the play, go to the offended head coach (the defense) and ask if they choose the result of the play (R1 is out at 2B on the throw and the batter has a 1-2 count) or the penalty for leaving early (no pitch, R1 is out, batter has a 1-1 count).

Multiple Option Plays by the Same Team - At the conclusion of the play, present the list of option plays to the offended head coach. Then, **address each infraction in the order in which they occurred.** For each infraction, the offended coach will choose between the result of the play, or choose the penalty for that particular infraction. If at any point the coach chooses a result that is a No Pitch, the infractions after that point are disregarded.

Example: **Two runners leave early on same pitch. The penalty is the same for both violations so both runners are out, and the batter remains at bat with the same count they had prior to the pitch. If we have multiple violations with different penalties, the defensive coach must select which penalty they want enforced.** Address each infraction in the order they occurred. The defensive coach will choose the result of the play or the penalty of that infraction.

Example: Two runners leave early, and the batter has an illegally batted ball (out of the box at moment of bat ball contact).

- If the defensive coach chooses leaving early, it is “No Pitch” and both runners are out for leaving early and the batter is still at bat with the count they had before that pitch. No Pitch negates the illegally batted ball.
- If the defensive coach chooses the illegally batted ball, it is a delayed deal ball, a strike on the batter and runners return to bases they occupied at the time of the pitch.
- Do not assess penalties for both leaving early and illegally batted ball

Multiple Option Plays by Both Teams - At the conclusion of the play, **FIRST** go to the head coach of the **OFFENSE** and present any option plays that resulted from defensive infractions. **The final choice of the offense becomes the new “result of the play”** to be presented to the defense. Then go to the head coach of the defense and present, in order, any option plays that resulted from offensive infractions. **The defense’s choice becomes the final result of the play.** **REMEMBER: Ask the offense first and the defense second.**

Example Play: R2 only. 1-1 count. 1 out. The pitcher delivers an illegal pitch AND R2 leaves early. The batter lines out to the second baseman who steps on 2B for the double play. Procedure: At the end of the play, first go to the offense and tell them that there was an illegal pitch. They have the choice of the result of the play (the double play) or the penalty for the illegal pitch (R2 returns to 2B, batter returns to the box with a 2-1 count and 1 out). The offense chooses the penalty for the illegal pitch. Then go to the defense and tell them that R2 left early. They have the choice of the new result of the play (Illegal pitch, R2 returns to 2B, batter returns to the box with a 2-1 count and 1 out) or the penalty for leaving early (no pitch is declared, R2 is out, batter returns to the box with a 1-1 count and 2 outs). Whatever the defense chooses becomes the final result of the play.

◆ 6.5 Correcting the Count

Making sure that the count is correct is the responsibility of every umpire on the field. If the plate umpire does not have the correct number of balls and strikes on a batter, they have until the at bat is completed to correct the count. If the plate umpire gives an incorrect count the base umpire shall call time and correct the count. You do not need to wait until someone asks you. If you know it is wrong, fix it.

If the teams disagree with the count given by the plate umpire and request that they check with their partner(s), the plate umpire should check if there is any doubt. To do this, the plate umpire should look to their partner and say, “I have [insert your count]. What do you have?” In more complex situations, the crew should come together and talk through the pitch sequence. As a last resort, ask the official scorer. It is better to have a



moment of embarrassment and be correct than it is to sound confident and be wrong.

If there is a checked swing or a full swing that is not ruled a strike, you only have until the next pitch to appeal. Once the next pitch has been thrown the previous pitch cannot be changed. This typically occurs with runners moving on the pitch. The plate umpire needs to give the count after steals, pick off attempts, checked swing requests, illegal pitches, timeouts, dead balls, and foul balls. The count needs to be given so both the offensive and defensive teams can hear and see it and make an appeal as necessary. This also allows the crew to be on the same page and make any corrections as needed.

NOTE: If the plate umpire signals a swing and then forgets that it happened during the ensuing play, the count can be corrected any time during the at bat if another crew member knows that it was ruled a strike.

◆ 6.6 Base Umpires Returning From Outfield Ball Coverage

Umpires should always be of the mindset to help the crew cover all plays. NCAA mechanics do not allow umpires to pre-game deviations. Base umpires that chase fly balls may return to the infield in rare circumstances in which it is apparent that there is a breakdown in the crew coverage, or when a timely return greatly enhances the crew's ability to be in position to get the call right. Decisions to return may NOT be pre-communicated, pre-pitched, or announced ahead of time. If a base umpire that chases a fly ball turns to see an opportunity to enhance the crew, it can be communicated at that time. Here are two examples to illustrate the difference:

- NOT ACCEPTABLE: On the crack of the bat, U3 holds up their hand indicating that they will return to the infield after chasing the fly ball.
- ACCEPTABLE: U1 reads a trouble ball to right field and chases it. After ruling on the catch/no-catch, they see an opportunity to return to help U3 with an extended rundown. U1 approaches the play when it's going away from them and clearly communicates "I've got this half!"

◆ 6.7 Checking the Pitcher's Resin Bag

Under the supervision and within the view of the umpire, a drying agent may be used by the pitcher. Powder-type resins which do not transfer to the ball are legal. Towels with drying agents that do not transfer to the ball such as the brand Gorilla Gold may be used. Resins, such as rock resin, that transfer to the ball and are not legal. Rock resin is typically in a larger bag and when you grip it, there is the distinct feeling of hard pebbles inside.

When a pitcher comes to the circle with a resin bag, one of the base umpires should check it. It does not need to be checked more than once per game

unless you detect something has changed. The best way to check is to physically examine it. Looking at it from a distance may not always be sufficient. If physically checking the resin bag, wait for an opportunity such as when jogging to your starting position to approach the circle and check it. Simply bend over and touch or pick up the bag. If it is legal, put it back where you found it and continue to your next position. If it is not legal, take it to the team's dugout and tell them why you are removing it from the game. There should be no argument as rock resin is not legal in any softball organization.

◆ 6.8 Hit By Pitch

Hit by pitch continues to be a challenging call for the plate umpire. There are multiple variables that the umpire must process simultaneously. When a hit by pitch occurs, call dead ball and give yourself time to process what happened. If there is a possibility of a swing attempt ask the appropriate umpire for help without the defense requesting it.

When setting prior to the pitch, notice if the batter has any part of their body in the space between the batter's box and home plate or over home plate. If any part of the batter that is not completely in the batter's box gets hit by the pitch, be prepared for a dead ball ball or a dead ball strike depending on the location of the pitch.

If the pitch is completely in the batter's box, determine if the batter leaned in or initiated contact with the ball and rule accordingly. The batter does not have to make an attempt to avoid the pitch but cannot move into the ball.

◆ 6.9 Hit by Pitch vs Off the Bat

When the pitch comes up and in it can be very difficult to tell if the ball hits the batter's hands or the bat. We can often get blocked and need to rely on all of our senses to determine the correct outcome. Listen to what the ball contact sounds like, listen and look for the batters immediate response. Do not be too quick with this call, you can make the ball dead at any time, but you cannot make it live again. If there is any doubt let the play play out then get the crew together.

If the ball ends up in fair territory do not kill it unless you are 100% sure that it hit the batter. If the ball ends up in foul territory, declare it a dead ball and signal accordingly. Base umpires are watching and will be able to help you if you are uncertain or blocked out during the play.

If you see a mark on the batter, it is acceptable to use that information to help make your decision.



◆ 6.10 Time Between Pitches Violations

When the home plate umpire determines a time between pitches violation has occurred, call time and step out from behind the catcher. **Point to the player who committed the infraction** and verbalize “Timing violation that is a ball (or a strike), on the batter” **Immediately give the new count**. If the result of the violation is ball 4, show 4 fingers with the left hand and award the batter first base. If the result of the violation is strike 3, signal the out and verbalize “strike 3 the batter is out”.

◆ 6.11 Leaving Before the Pitch Is Released

The umpire should focus on the runner’s foot that will leave the base last and peripherally watch the arm swing of the pitcher. When the pitcher’s arm and body line up (hand at the hip), the ball is considered to be released. Any benefit of doubt should be given to the runner. When a runner leaves a base before the pitcher releases the pitch, the umpire signals a delayed dead ball and verbalizes “Early.” When the play is concluded, the umpire will inform the crew and the offended coach of their options.

◆ 6.12 One Umpire Calls Obstruction and Another Umpire Has a Play on that Runner

The crew should be aware when one of the umpires has called obstruction on a runner. However, it is possible for one umpire to call a runner out or safe on the continuing play without being aware that they were in an obstructed status. When this happens, the umpire that called obstruction should observe the continuing play and then assert themselves if the runner did not reach the base they would have obtained had the obstruction not occurred.

If the runner is subsequently called out in this situation, the umpire that called the obstruction should immediately verbalize and signal “Dead Ball,” walk assertively toward the apparent out, and announce the award.

If the runner is subsequently called safe in this situation, the umpire that called the obstruction should wait until the end of playing action. If the runner would have advanced further, the umpire that called obstruction should then call “Dead Ball,” and announce the award. If the runner would not have advanced further, there is no action required.

Depending on the noise level and other circumstances, it may be necessary to repeat “Dead Ball” multiple times, with arms raised, while walking toward the call. When play comes to a stop and they have the attention of the participants, they should point back toward the location of the

obstruction, announce “That was obstruction!”, then point to the runner and announce the base award(s). For example, “You, score,” “You, return to 3B,” etc. If there is any doubt about where to place the runner, prior to announcing the award, the crew should discuss it.

◆ 6.13 Interference, Obstruction, or Contact Between Two Umpires

In most cases the umpire closest to the interference, obstruction, or contact should make the call – unless that umpire has other more urgent duties and does not see or recognize it. In such cases, the next closest umpire is responsible for making the call. If you are the next closest umpire to the interference, obstruction, or contact and see the incident, look first at the closest umpire to determine if they saw it. If you determine the umpire saw it, then do not signal or call it. If you determine the other umpire did not see it, signal and/or call it yourself. Be assertive and aggressive and prepared to explain your judgement.

If the infraction is equidistant between two umpires and both see it, the call defaults to the umpire the interference, obstruction, or contact is going toward. Eye contact between partners before making this call will usually prevent a double call.

Use of the safe signal to indicate no infraction is an excellent tool for letting your partner know you have seen the action and made a judgment on it and will handle any questions from the teams.

◆ 6.14 Timing Play

The home plate umpire or U1 rotated into the point of plate position are usually responsible for determining if the runner touches home plate prior to the third (non force) out of the inning being made. The umpire should then immediately make the correct signal for the run scores or the run does not score.

However, there are situations when the plate umpire is responsible for runners at both home plate and third base. When the third out of the inning is on a tag play at third base called by the home plate umpire and there is the potential for a timing play at home, the remaining base umpire must be alert to the timing play. The base umpire must view the timing of the tag at 3B in reference to the lead runner touching home plate. **The base umpire taking responsibility for the timing play should move confidently towards home plate signaling that the run scores or that the run does not score.** **The base umpire who chased the fly ball should also observe the play and provide assistance if needed.**



◆ 6.15 Getting the Call Right/Going for Help

The first requisite of an umpire is to ultimately get all decisions correct. Umpire pride is important, but never as important as getting the play right. It is the philosophy of the NCAA that umpires always seek to get the call right. This may involve the reversal of a previously rendered decision. However, the correct decision, not the pride of any umpire, must prevail. Following are general guidelines for this policy:

1. No umpire shall criticize or interfere with another umpire's decision, unless asked by the one making it; however, if there is a misinterpretation of a rule, it should be brought to the attention of the calling umpire and entire crew.

2. An umpire is urged to seek help when their view is blocked or positioning prevents them from seeing crucial elements of a play. An umpire is also encouraged to seek help in instances when they have any doubt and a partner has additional information that could lead to the proper ruling.

3. In the situations listed below, **a partner, who is 100% certain** they have additional information unknown to the umpire making the call, should **approach unsolicited** and alert the other umpire to such information. However, the **ultimate decision** to change a call **rests with the calling umpire.**

- a. Deciding if a home run is fair or foul.
- b. Deciding whether a batted ball left the playing field for a home run or ground rule double.
- c. Cases in which a foul tip is not caught within foul tip guidelines.
- d. Cases in which a foul fly ball is caught or not caught.
- e. Cases when an umpire clearly errs in judgment because they did not see a ball dropped or juggled after a tag or force play out call.
- f. Spectator interference plays.
- g. Interference by coach or on deck batter on a foul ball attempted catch.
- h. When you know crewman did not observe their calling play.
- i. Coaches assist.
- j. Catch and carry.
- k. Umpire jeopardy.

4. Umpires are not to seek help on plays on which they are 100% confident in their judgment and view of the play. Head coaches are not entitled to a second opinion when the calling umpire is certain their decision is correct. On the other hand, umpires are not to "die" with a call in cases where:

- a. The calling umpire is not 100% certain they are right, and
- b. Another umpire has additional information which could lead to a proper ruling. Both NCAA philosophy and umpire integrity, consistent with NCAA rules, dictate that calls are reversed in this situation.



5. When an umpire seeks help, they should do so shortly after making the original call. They should not have a lengthy discussion with the head coach or others and then ask for help. If the calling umpire seeks help, they should include all umpires and focus on the umpire who would likely have the best position to see the elements of the play. This conversation must take place away from players or coaches. The calling umpire will state what they have and ask their partners for any additional information. The non-calling umpires will provide any information that they have from observing the play or from a rule interpretation. Do not withhold information from the on field discussion, give the calling umpire all the help that you can. **After a request for an umpire conference has been granted, coaches are not allowed to continue to argue a call once the final decision has been made. If a call is reversed, coaches are entitled to an explanation from the crew.**

6. Judgment calls, which have traditionally not been subject to reversal, include steal and other tag plays (except if the ball is dropped without the umpire's knowledge as discussed above), force plays (when the ball is not dropped and the foot is not pulled), and balls and strikes (other than half swings). This practice shall continue.

7. Once a batted ball is declared dead it cannot be made live and remains dead until an umpire indicates resumption of play. Umpires can, however, correct calls regarding the granting of dead-ball awards if additional information is made available to the calling umpire and the result remains a dead ball (i.e., a foul ball may be changed to a dead-ball award, or vice versa). For example:

- Out-of-the-park homeruns;
- Hit-by-pitches; and
- Ground rule doubles.

Overall, umpires are urged to seek help on reversible plays in which they may have erred by not seeing a crucial element of a play. Such meetings, while necessary, should be infrequent and not become a substitute for umpires seeking proper angles, exercising sound judgment, and having the conviction to stay with a call that an umpire believes was properly made.



6.16 Conference Management

All offensive and defensive conferences that delay the game between two or more players or a team representative and a player must be recorded and the head coach notified which type of conference was charged. Write down the team, the inning and who initiated the conference.

Be consistent yet appropriate with the time allowed for a conference. Defensive conferences are usually longer, and offensive conferences are often quicker. Game situations can also determine the amount of time allowed for a conference. If the conference is not ending after a reasonable



amount of time, break it up. For a defensive conference, walk purposefully, with your head up, to the pitcher's circle (or wherever the huddle is) and ask: "Are you about ready?" Do not leave until the conference breaks up, and do not return to the plate without the catcher. For an offensive conference, walk purposefully to the huddle and ask, "Are you about ready?" Do not leave until the conference breaks up and do not return to the plate without the batter.

If two or more defensive players meet to have a conference and a coach joins this conference here are the parameters to determine what is charged.

1) When the players get together and you see that a coach is getting ready to exit the dugout and come out to join the players this will be a charged representative-to-player conference.

2) When the players get together and there is no movement by a coach out of the dugout, this is a charged player-to-player conference. However, if the players have been meeting and eventually a coach joins the conference (there was no initial movement by a coach to come out of the dugout) BOTH a player-to-player and a representative-to-player conference will be charged.

If an injury occurs on offense or defense and the coach wants to check on the player, go with the coach or designate a base umpire to attend the meeting. Stay close. If the talk turns to game strategy, ask the coach if they want a conference. If they do not, instruct them to play ball. If a player requests time to fix or replace equipment, go to the dugout with the athlete and monitor the situation. If an illegal pitch has been called and you are asked to tell the pitcher what made the pitch illegal and the coach is present, an umpire must stay until the discussion is over and the coach leaves the field.

Be preventative, if a team member is going to violate the conference rule do not grant the conference or tell them no/stop/wait. If they insist on the conference enforce the penalty by ejecting the team member who initiated the conference. Do not charge either team with a conference if performing your umpire duties cause the initial delay of the game. When you are ready to resume play and a team is still conferencing, advise them that it is time to play ball. If they do not respond immediately, ask if they want to request a conference (if they have one remaining).

6.17 At the Conclusion of the Game

The last out of the game does not dissolve the crew. When the final out is made, umpires must remain aware of each other's position and remain alert to the actions on the field. Just because the game has ended doesn't mean we stop holding all participants accountable for their behavior. Any behavior that would be addressed during the game must be addressed post

game as well. One crew member will be closer to the exit than the others, so it is a good idea for that member to wait about 15 feet down the line beyond first or third base for the crew to gather and exit the field together.

- Remain alert for possible appeals or protests that could still be legally made.
- Briskly walk off the field with your partners by the most convenient route to the umpire area.
- Avoid mingling or moving through student-athletes.
- If you have reason to believe that following the most convenient exit from the field would lead to an altercation or subject the crew to undesirable comments, then use a different route.
- Do not engage in crew congratulations or handshakes until you are off the field and away from public observation.
- Do not congratulate any coach or team members.
- Once the crew is away from and out of earshot of the public, have a thorough postgame review before checking phone messages.
- The crew's postgame discussion should cover these topics:
 - Things that went well or we did well in the game.
 - Anything unusual, vague or confusing that happened.
 - Look up any questions concerning rules or mechanics that came up during the game.
 - How well did we follow what we talked about in the pregame?
 - Where could we improve or do things differently?

Last, when you are by yourself, reflect on the entire game. Note the things you did that went unnoticed but you know you did exceptionally well, as well as areas where you know you to improve. Acknowledge what you did well as reinforcement. Acknowledge where you could improve as an incentive. Thoroughly absorb the crew's postgame. If you had any specific goals, did you meet them? Be honest with yourself.

At softball facilities which provide an assigned person to deliver softballs to the umpire during the game, all remaining softballs should be handed to that person before leaving the field at its conclusion. Otherwise, the plate umpire should hand the remaining softballs to game management staff, place them near the dugout or ball return, or simply take them to the locker room. Do not drop balls at home plate or toss/roll/throw them toward the dugout or backstop.



Section

7

Mechanics

Mechanics are the physical part of umpiring. They describe how you move on the field, make signals, and position yourself to be in the best possible location to make an accurate call. They are a series of choices based on where the next most likely play will occur. In this manual, specific guidelines have been developed for you to follow in order to keep all the elements of the play in front of you: the ball, the base, the defensive and offensive player. You need to read the play as it develops and adjust your position to have a better view of the action.

◆ 7.1 Crewness Through Mechanics

NCAA mechanics have seen significant changes over the years as we attempt to keep up with the increased athleticism of the players. All NCAA umpires are expected to perform mechanics based on this umpire manual. Deviations from the published mechanics may occur in extreme circumstances; however, personal decisions to routinely umpire your own way are not acceptable. The mechanics are progressing to allow us to individually move where the play takes us and be in the best position possible to make the call. It is important to draw a distinction between this freedom of choice within the prescribed mechanics and a conscious choice to abandon our responsibilities to the game and to the crew by making an active decision to deviate.

Consider the impact of choosing to deviate. A disregard in the application of mechanics results in poor or no communication, inaccurate rotations, missed coverage, and confusion for umpires. This can break the cohesiveness of the crew.

When working with umpires of different levels or from different parts of the country, we should all be able to step onto the field and know what every umpire is doing. If we all commit to working games as described in this manual you can step on the field with anyone and work well together as a crew.

Someone is always watching. While a deviation may have worked for you in a certain situation, your reasons may not be fully understood by others who will emulate what they saw on the field. Further, we cannot choose the mechanics that we like, and disregard or change the mechanics that we don't. Similar to how we do not cherry-pick the rules we wish to enforce, we do not modify our mechanics based on personal preference without potential negative consequences. More experienced umpires carry the responsibility of presenting a constant example for less experienced umpires who are still learning the system.

The Softball Umpire Program is working hard to standardize how we teach the philosophies and mechanics in our manual. We are asking any umpire entrusted with the responsibility to teach or observe to rely on what is taught here in the manual. There are plenty of opportunities for umpires to show individuality; but, when it comes to mechanics, we expect cohesiveness.

While the SUP is firm on its goal to standardize mechanics, it is fully open to new ideas and improvements. If there is a mechanic in this manual that needs reconsideration, submit an NCAA Softball Mechanics Change Submission Form to the SUP on the Central Hub. All submissions are carefully considered and vetted by a committee of working umpires and the SUP staff. No submissions are disregarded without review.

Umpires communicate through body language, signals, voice, and mechanics. Every move an umpire makes on the field is sending a message to their partners, the players, coaches, and fans. Umpires must be aware of how they stand, how their hands are positioned, how they hold their head, and how they move about the field. The NCAA discourages umpires from standing with their hands on their hips -- momentary pauses to relax are acceptable, but should not be a frequent occurrence. Learn to use your body language to send the message you want to portray — an umpire who is approachable, engaged, and confident in their abilities.



7.2 All Umpire Positions

Pre-Pitch Preparation

Before every pitch, mentally answer these questions:

- Are my partners in the correct starting position?
- How many outs are there?
- Where are the runners?
- What is my fly ball coverage area?
- Where are the defenders in my area positioned?
- Where do I go if a partner chases?
- Do I have any tag up responsibilities?
- Do I have an umpire-to-umpire signal to give?
- Where do I go on a hit to the infield?
- Where do I go on a hit to the outfield?
- Is there an opportunity for a full rotation?
- Who has check swing responsibility?
- What is the potential for a steal or pick-off?
- Do I have responsibility for a runner leaving early?

By reviewing as much as you can before the pitch, you not only maintain focus but also increase your ability to recognize and respond to the action without hesitation.



Force Plays

- Calling distance: no closer than 18 feet, allowing the umpire to see, with minimal eye and head movement, all three elements of a force play: the ball in the fielder's glove, the base runner touching the base, and the fielder's foot on the base. If you are too close to the play, you will not be able to see the defender reaching for a high throw and their foot on the bag at the same time. When starting at a depth of 6-12 feet, be sure to re-establish your calling distance to at least 18 feet.
- Work for a 90-degree angle from the throw on a force play. When it's not practical or possible to obtain a 90, find an appropriate angle that is not straight-lined with the throw or in a throwing or running lane. Defenders will usually stretch from the bag in the direction of the approaching ball, making the desired angle for seeing the fielder's foot on the base a 90-degree angle to the path of the ball. For force plays at first base, no more than 50 degrees off of the foul line.
- When the ball is hit on the ground, see the ball fielded by the defense, watch the release of the ball and track the ball to the base, watching the elements come together.
- Be alert to obstruction or a collision.
- If the defender is already in possession of the ball and it becomes a footrace to the base. The umpire should close the distance to the base and obtain the best angle to see the runner and defender touch the bag.

Tag Plays

At a Base/Home Plate

- Calling distance tag play: 3-10 feet.
 - Initially obtain a point of base/plate position to read the play.
 - As the runner and ball approach and the defender adjusts their position, move to a calling position that ensures that all the elements are in front of you. Continue to read the play as it develops, determine if obstruction, interference, and/or a collision has occurred, then adjust position as needed to see the application of a tag.
 - Umpires must allow the entire play to conclude before rendering a decision. If anything non-routine occurs, the umpire should be prepared to describe the call verbally and with the appropriate signal(s).
- Additional elements to consider.
- Does the defender maintain possession/control of the ball?
 - Does the runner maintain contact with the base?
 - Does the runner attempt to dislodge the ball?

Between Two Bases

- Seek a position to see the tag side of the runner.
- Does the runner stay in the runners lane?
- Does the runner try to dislodge the ball?
- Does the defender have the ball in their glove or bare hand when tagging the runner?



Additional Duties

- Know your check swings responsibility and focus on the bat, the front hip of the batter and home plate.
- Never signal/echo foul balls.
- Never stop runners on foul balls or tell them not to slide.
- Always know the location of the ball.
- Always work to keep the ball, base, runner and fielder in front of you.
- Arrive ahead of the action and obtain a set primary calling position on every play.
- On tag-up plays, align yourself in fair or foul territory to view the fielder and the runner(s), consider where your next play will be in choosing your position.
- Remain aware of the running and throwing lanes when you move as a result of a hit or play, do not get hit by a thrown ball or player.
- Use parallel movement with runners that are your responsibility.
- **When coming inside the diamond on a hit, use a pivot. Start the pivot no more than 10 feet inside the baseline. Always pivot open toward the runner coming at you. If necessary move back outside the diamond to keep the ball in front of you.**
- When moving through foul territory, always move between the base and the base coach. Never allow the coach to be between you and the base. Communicate your movement to avoid contact.
- Recognize your next play and be ready to move to the next primary calling position when your previous call/responsibility is complete.
- When an umpire is responsible for all calls at a base this includes but is not limited to: reading the play/throw to be in a primary position for all force and tag plays, watch for any obstruction/interference/ collision, observe all touching of bases, and rounding and returning. At first base specifically it also involves the over running of first base and the enforcement of the look back rule.
- **Watch all plays not in your calling area and be prepared to give help if asked or provide help to get the call right if you are 100% sure you have additional information.**
- Do not over-hustle. Often a step or two is all that is needed to achieve the best position. Avoid crossing any running or throwing lanes.

Point of Plate

The point of the plate is the best starting position for plays at the plate. This position is essentially located by stepping straight back from home plate toward the backstop. From here the umpire can see the path of the runner, the movement of the catcher, the flight of the ball and the possible development of obstruction. The umpire will then determine if they need to change their position based on the development of the play. This could be a calling position if the play dictates it.



Point of Base

Similar to the concept used at the plate, when an umpire reads a potential play at a base, they should move to an initial starting position known as the Point of Base then adjust from there as the play develops. Generally speaking, the point of base is a position approximately 6-8 feet away from the base on the opposite side as the ball. From here the umpire can see the path of the runner, the movement of the fielder, the flight of the ball and the possible development of obstruction. The umpire will then determine if they need to change their position based on the development of the play.

The Classic 90

The Classic 90 is a calling position that is 90 degrees to the path of the approaching runner, regardless of the path of the thrown ball. This position works best when a fielder is straddling the base (allowing the runner full access to the leading edge of the base) or when the fielder in possession of the ball extends it parallel to the basepath to make a tag. For example, on stolen base attempts at 2B, the Classic 90 would be 3B-2B-line extended. On plays at the plate, the Classic 90 would be 1B-line extended.

The Wedge View

As defensive players are not allowed to position themselves between the runner and the base without possession of the ball, fielders frequently set up outside the basepath. Almost always, this results in a swipe tag as the runner goes by. Classic 90 or traditional calling positions may not give the umpire the best possible view of this type of tag because they can result in the runner blocking their view of the tag.

The Wedge View refers to an umpire's continuously-adjusting position at a base/plate when the fielder is receiving the ball and moving to make the tag. This view keeps the three elements in view at all times: 1) the side of the runner's body that will be tagged, 2) the part of the base/plate that will be touched by the runner, and 3) the tag.

To establish a Wedge View, the umpire must quickly move from the point of plate/base, and set up approximately 6' - 8' behind the fielder, imagining a rope connecting the umpire's belt buckle to the fielder's plate/base-side hip. If the fielder moves up, the umpire moves up the same distance. If the fielder rotates, the umpire moves along an arc maintaining the distance and relative position with respect to the defender's hip and shoulders. In essence, the umpire is always able to see the same thing that the fielder sees. As the fielder brings the ball to the runner, continue to rotate with the fielder if necessary to keep the tag in view.

Because of this dynamic relationship between the umpire, the runner, and the fielder, there are an infinite number of possible calling positions that can result. For example, on plays at the plate, this may result in the umpire rotating to the first-base side of the plate. The umpire must move smoothly and maintain control of their field of view.

In all situations, staying close to the fielder gives the umpire the ability to change angles quickly to prevent the runner from coming between the fielder and the umpire; therefore, allowing a great view of the tag or no tag and the touch of the base/plate by the runner. Also, this allows a great view of obstruction.

Rundowns

Successful coverage depends on timing and deliberate movement. When working a rundown alone, the umpire must find a position that is a comfortable distance from the baseline to move laterally between the bases while observing the action. The umpire should square their shoulders to the runner and move sideways with the runner. It is not necessary to keep up with the runner; rather shadow the runner's movement along the baseline. It is not always possible to maintain a view of the tag-side of the runner, therefore umpires must work together on these plays whenever possible. When working a rundown together, umpires should attempt to set up on opposite sides of the basepath communicating with each other "I've got this half." When a tag attempt occurs out of view of the responsible calling umpire but within the view of the other, the umpires should look to each other and communicate who will take the call. When umpires are not sure who should make the call, quick eye contact and a verbal acknowledgment of "I have the call" or a physical acknowledgement like tapping your chest will resolve the problem.

Dropped Third Strike

Plate Umpire

When the third strike is caught, the plate umpire should give the standard out signal, and if necessary add the verbal "the batter is out" to alleviate any confusion.

If the third strike is obviously not caught, the plate umpire should give a strike signal followed by a standard safe signal. If there is confusion, or if it's not obvious, the plate umpire should add a verbal "no catch."

If the plate umpire is uncertain whether or not the third strike was caught, they should look to the base umpire(s) for help before making a call. If there is any question on the batter attempting a swing go quickly for help, you do not need to be asked by the defense.

Base Umpires

With two strikes on the batter, pre-pitch prepare whether or not the batter is entitled to run on a dropped third strike. If a third strike is obviously caught or dropped, there is no requirement to give a signal to the plate umpire. However, if the batter is entitled to run and there is any question whether or not the third strike was caught, the base umpires should emphatically give the ball is caught or ball is not-caught third strike signal to the plate umpire.



The signal should be clear and easy for the other umpires on the crew to see. If the check swing is your responsibility be prepared to respond quickly to the plate umpire if asked for help.

Infield Fly

Prior to the pitch and before stepping behind the catcher, the plate umpire is responsible for initiating the infield fly signal. This signal is given every time a new batter comes to the plate and there is an infield fly situation. Each base umpire acknowledges the infield fly rule by returning the same signal to the plate umpire. When the infield fly situation is no longer in effect, the umpires should again communicate by wiping the infield fly off or use the two out indicator. If the plate umpire fails to initiate either signal when warranted, the base umpires should initiate to the plate umpire before the next pitch.

All umpires share concurrent authority to judge an infield fly and initiate the call. **After any umpire calls the infield fly, all other umpires shall echo the signal.** An infield fly is not called until the ball has reached its highest point and can be caught with ordinary effort, if an infielder can nearly settle under the ball while still facing the infield. If you feel an infielder could have caught the ball with ordinary effort and an outfielder calls the ball and takes the catch, it is still an infield fly. When judging if a ball is an infield fly, remember that it must be a ball in flight, not a bunt or a line drive.

Home Run

The crew must communicate and continue to umpire on the hit. If the ball is close to the foul pole, the umpire who chases will turn, set and straddle the line, and focus their view on the ball as it crosses the vertical plane of the fence and the foul pole. Give the approved signal immediately after the ball passes over the fence while you are facing the outfield. Do not wait for the ball to land before giving the signal. If the ball is not near the line, chase parallel to its flight, stop before it clears the fence and signal immediately facing where the ball went over the fence. When the plate umpire is responsible for the call, they must move to achieve the best angle and be set to make the call. On out-of-park home runs, the plate umpire must watch all runners complete their base running responsibilities before ruling on dead ball appeals, then put a new ball in play.

The Power of the Point

The point signal is extremely valuable and effective when used wisely. The point brings attention to an important element of the play. It should not be used on routine plays. Some examples of effective use of the point are:

- Ruling on close check swings or bunt attempts by plate umpires (not on obvious bunt attempts or swings),
- Specifying which player has committed an infraction such as interference or who is out,
- Indicating the location of a tag when it is not obvious,
- Indicating that a ball is on the ground when it is not obvious, and
- Pointing out that a fielder kept contact with the bag.



◆ 7.3 Plate Umpire

Plate Stances

When working the plate, you may use the Box Stance, Gerry Davis, Modified Gerry Davis, or Heel/Toe. The Scissors Stance is not permissible in NCAA play. When choosing a stance, it is most important to choose a stance that is comfortable, athletic, and repeatable by the individual plate umpire.

Set up in the slot with all of these stances. It is imperative that you are able to see the outside corner of the plate with an unobstructed line of vision of the entire ball from the pitcher's release point through the strike zone to the catcher's glove. Prioritize an accurate zone over exact foot placement. Plate umpires should set their head height in a position that allows total view of the strike zone plus; however, your chin should be no lower than the top of the catcher's helmet.

Box Stance

Your feet are apart slightly wider than shoulder width. Your non-slot foot is placed on the ground about a foot behind the middle of the catcher's back in line with the point of the plate. The slot foot is parallel to and in line or even with the non slot foot at a distance that places the head in the slot. Both feet are pointing toward the pitcher. Drop set by bending the knees.

Gerry Davis

Start with your hands on your knees base set. Your feet are wider than shoulder width, feet approximately parallel to and generally even with each other. Your hands should be gripping your thighs above your knees. Your upper body weight rests on your knees with your elbows straight which provides consistent head height. Adjust head height with the width of your feet. Begin about an arm's length behind the catcher with your nose in the slot. As the pitcher commits to deliver, drop your hips slightly about two to three inches to bring your line of sight parallel to the ground and to eliminate neck strain.

Modified Gerry Davis

This is the same as the Gerry Davis stance; however, it is not necessary to drop your hips as the pitcher commits to deliver the pitch.

Heel-Toe Stance

Your feet are wider than shoulders width. Your shoulders and body are nearly square to the plate so that a line drawn down the middle of the umpires' waist would bisect the plate. Your slot foot should be in the slot pointing directly at the pitcher's plate and in line with or slightly in front of an imaginary line drawn from the catcher's heels to the toe of the slot foot. Your non-slot foot is angled no more than 45 degrees. You should be no deeper than a closed fist between your non-slot foot and the catcher's back when you drop set. Drop set by bending your knees (like sitting in a chair).



Working the Plate

- Work the slot. Adjust as needed to not be blocked out by the batter or catcher.
- Use a balanced comfortable stance that allows you to drop to a solid set and to see the entire strike zone and to exit the plate area quickly.
- Develop a rhythm such that you are set before the pitch is released but not down in a set position too long.
- Use the same stance (mirror image) on both sides of the plate.
- Do not touch the catcher.
- Track the pitch with your eyes, moving your head slightly to allow both eyes to focus on the ball.
- Do not indicate pitch location with body movement.

Strikes

- When a strike is called use a loud and distinct verbal. The verbal should be made in the down position with the signal in the up or going-up position.
- Use the same timing for a swinging strike as for a called strike, except do not verbalize the call.
- Finish a called third strike differently than a routine strike in both the verbal and signal.
- Step back out of your stance and relax after you have given your signal.

Balls

- Verbalize a ball call in the down position before you begin to stand up.
- Ball calls are just as important as strike calls. Make sure you verbalize each ball call in the same tone, with the same timing, and same emphasis.
- Step back out of your stance and relax after you have given your signal.

General Plate Duties

- Look at your partners at the beginning of the game and each half inning to see if they are ready for play, do not point at them. If they are not ready, wait.
- Make sure all runners are on base, before you use the “Play Ball!” signal after every suspension of play. It can be done with a quick point and low verbal, so both the batter and catcher hear it.
- Work in priorities: pitcher, pitch, batter and action.
- Prioritize pitch location over secondary calls such as checked swings and illegally batted balls. Know the location of every pitch. Always take your position behind the catcher with your eyes up and your mask on when getting ready to call pitches.
- Give the count after a steal, pickoff attempt, checked swing requests, illegal pitch(s), timeouts, dead balls and action pitches (3 balls or 2 strikes).
- Present the count when the pitcher is facing home plate.
- Always ask for help on a checked swing when asked by the defensive team. On ball-four or strike-three situations, go for help immediately (before being asked) if there is any question whether or not the batter swung.



- It is acceptable to go for help when a batter has two strikes and bunts or slaps and the ball becomes foul. Go to the umpire who had the checked swing responsibilities and ask, “Do you have a bunt?”
- Remain alert for any reaction, conference or substitute request from the batter, catcher or coaches.
- Be expedient when documenting and reporting line-up card changes and all warnings. Report all changes to the official scorer and to both dugouts.

Watching Warm-up Pitches

It is good practice to watch a few warm-up pitches, which allows you to get a feel for the speed and movement of the pitches and how the catcher works. In the top of the first inning, watch the second, third and fourth pitches. Do the same in the bottom of the first inning and for any new pitcher. NOTE: Watch only if the person catching is fully equipped.

After the Ball Is Hit

- Call all fair/foul and catch/no catch decisions unless a base umpire chases.
- Call all fair/foul decisions on all bounding balls from home plate to over first and third bases.
- Trail the BR no more than 15 feet up the line when first base is unoccupied and the play is going to first base. Be set for the play at first.
- Trail the BR no more than 10 feet up the line when there is a runner on first base and the play is at first base. Be set for the play at first, and then move to third base for a possible play.
- You are responsible for runner’s lane interference calls all the way to first base.
- Cover third base and home plate if U1 cannot get to the plate on a possible full umpire rotation.
- Do not call or signal obvious foul balls. Batted balls down the line that pass between the fielder and the base coach’s box deserve a call. Straddle the foul line (or foul line extended) when judging a fair/foul. On scorching fair/fouls, judge the fair/foul from your position, then move to the foul line to make the call.
- At the conclusion of a play return to home plate quickly. Stay alert in case a coach approaches to request a conference or to make a change.
- When a live ball is nearing a dead-ball area, ball status is a priority for the plate umpire.
- Allow teams to handle/move their own equipment. Umpires are discouraged from touching any team equipment except during bat checks.

Force Plays at the Plate

Typically, NCAA mechanics direct umpires to obtain a 90-degree to the throw on force plays. Plays at the plate require plate umpires to consider more scenarios. Frequently, when the throw is off-line, the catcher will



release the plate in order to move with the ball and then change it to a tag play. A 90-degree to the throw can put you in a spot to not be able to see the tag. Consider a location between deep point-of-plate and third baseline extended so that you aren't straight-lined on the throw and so that an adjustment can be made if the play quickly changes from a force play to a tag play.

7.4 Guides – Base Umpires

Pre-Pitch Mechanics

- Starting Position On the Line:
 - No Runners on Base: 18-20 feet beyond the base completely in foul territory within one foot of the foul line.
 - First Base with Runner On: 6-12 feet beyond the base completely in foul territory with their field side foot no farther than one foot off of the line.
 - Third Base with Runner on Second: 6-12 feet beyond the base completely in foul territory with their field side foot no farther than one foot off of the line.
 - Third Base with Runner on Third: 6-12 feet beyond the base completely in foul territory. Distance from the foul line up to four feet, depending on where the runner takes their lead, to see the check swing.
- If walking the line, do not take more than two steps and end your step on the outside push foot. Be stopped before the ball arrives at the plate.
- If using a set position on the line, you should be set once the pitcher completes taking the signal. Move out of the set position between pitches.
- If using a set position as U3 rotated behind second base, you should be set once the pitcher steps on the pitcher's plate. Move out of the set position between pitches.
- In a three umpire system, when U1 is counter-rotated between 1B and 2B, they have the option to come to set, stand up, or take a step with the pitch. In a two umpire system, the base umpire may always choose between coming set, standing up, or taking a step with the pitch. The umpire needs more flexibility in timing and positions as they have more moving pieces to consider and need to keep their head on a swivel.
- Always choose a position that will not interfere with a fielder.
- Always choose a position that looks engaged and ready for play.

Working Between Pitches

Working between pitches is a movement used by base umpires on non-batted balls. The mechanic enables the base umpire to remain alert to the runner(s) for whom they are responsible in case of a play. This mechanic ensures readiness and credibility in the event of an immediate pickoff attempt or a delayed throw from behind the runner or possible obstruction on the runner's return to the base. If the catcher immediately throws to a base after the pitch, the umpire simply reacts to that action by committing to a calling position on that runner. When the throw is not immediate, use the method described below according to the starting position.

Starting Position — On the Line: There is not one position that works best for every pick-off attempt at first or third base. Depending on who covers and the likelihood of how the runner will return, working between pitches as a first-base or third-base umpire on the line may be simply staying in the set position until the runner has returned to the base or is moving to maintain an unobstructed view. Watch the catcher's actions with the ball, be alert to the defender's actions and watch for obstruction on each runner's return to base. Return to your standing position once the runner has returned to the base and the ball is in the pitcher's circle.

Starting Position — U1 Counter Rotated: There are three musts for the first-base umpire on every non-batted ball.

- Move out of the set position.
- Watch the ball and the catcher's movement.
- Remain ready for a play, Once the ball is in the pitcher's circle and the runner has returned to the base, return to your starting position.

When the first-base umpire only has responsibility for R2; read the movement of the closest defender in order to determine your primary position. When F4 is covering second base, allow the defender to get 6-12 feet away from you to read the play and take the correct path to second base. In most cases if the defender does not throw to second base, you will take only a few steps toward second base. Remain alert to F6 covering if F4 does not move and react accordingly. Watch for obstruction on R2 returning to the base.

When the first-base umpire is only responsible for R1 read the movement of the closest defender to know where the primary position is. In most cases, F3 will be covering first base, but remain alert to F4. When there is no throw, take a few steps parallel to the baseline toward first base remaining ahead of R1. Watch for obstruction on R1 at first base.

When the first-base umpire is responsible for R1 and R2, take a couple of steps forward from your starting position. Watch for obstruction on R1 and R2 if runners return to their bases. Remain ready to commit to either play.

Appeal for R2 Leaving Early When U3 Has Tag up Responsibility and U1 is in the Infield

U3 will be responsible for the tag-up at 2B and appeal when R2 is ON THE BAG WAITING TO TAG UP on a fly ball between the center fielder and the right field dead ball line and U1 does not chase. U3 will take the verbal appeal of R2 leaving early and the appeal if the defense throws the ball to second base and R2 is on third base. U1 will take the play if R2 advances some distance when the ball is hit and returns to tag-up after the catch. This concept of split coverage requires clear communication from the crew and an awareness of each umpire's responsibilities.



When the ball is caught, U1 should quickly check the location of R2. If it is obvious to U1 that R2 did not attempt to tag up (more than a few steps off second) then U1 knows that any throw back into second base with the runner returning is a timing play and will rule on it accordingly. If there is any question if R2 tagged up legally, U1 should treat it as if they have and call any play with R2 coming back into second base as a tag play. If U1 has the tag up status of R2 incorrect on a play back into second base, U3 shall provide U1 with the correct tag up information.

In each example below, there is a runner on 2B, a fly ball hit between the center fielder and the right field out of play line and U1 does not chase the fly ball:

- R2 waiting on the base to tag-up; on the catch R2 advances to 3B; The defense makes a live ball appeal at 2B -- U3 will look to U1 and say "I've got it," then rule on the appeal play.
- R2 runs 20 feet toward 3B, then stops to see if the defense makes the catch; ball is caught; R2 races back to 2B; ball is thrown to 2B for the obvious appeal -- U1 will look to U3 and say "I've got it," then rule on the appeal play.
- R2 races toward 3B thinking it will be a hit; ball is caught; R2 races back to 2B and tagged while off the bag -- this is not an appeal, U1 will call the runner out.
- R2 waiting on the base to tag-up; on the catch R2 advances to 3B; Defense throws the ball to 3B where U3 calls the runner safe; After time is called, the defense appeals the runner leaving early at 2B -- U3 will look to U1 and say "I've got it," then rule on the appeal play.

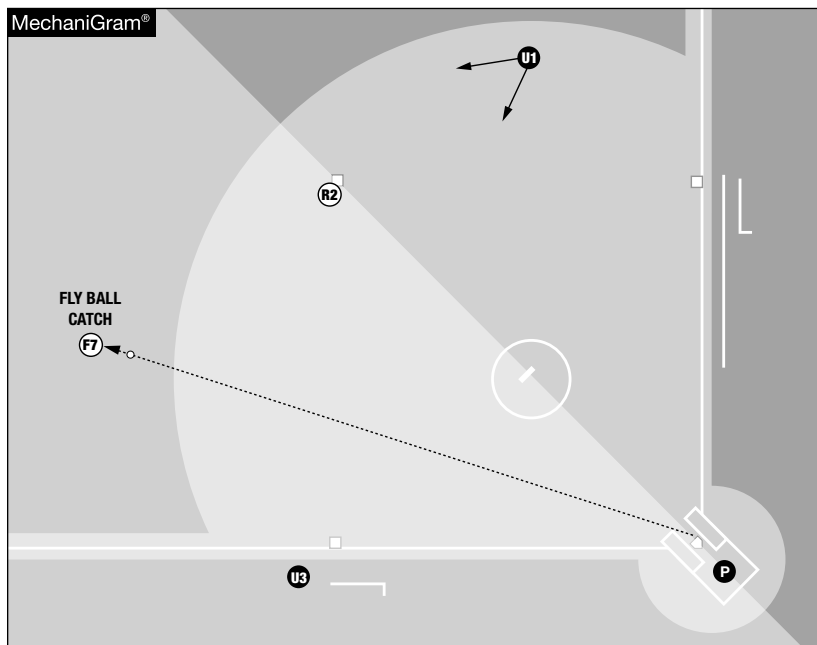

U1 has R2 tag up responsibility.

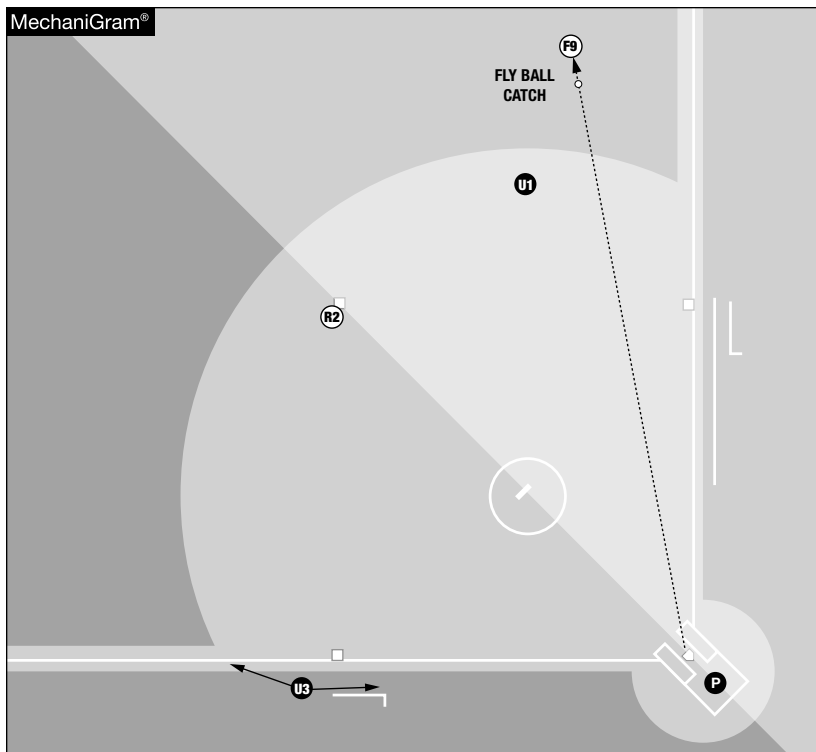

U3 has R2 tag up responsibility.

◆ 7.5 First-Base Umpire

Starting on the Line

- When starting with R1 at first base, take several steps back when the ball is hit to get to force depth as you adjust your angle for any force play.
- With a runner on first base only, be prepared to go home if there is an overthrow at first base.
- If the ball is hit to right field, you may use foul territory to watch the runner at first base but avoid going farther than 45 degrees off the line. You risk having your vision obstructed by the coach or runner. Use this position only on a throw from F9 or when F4 comes towards you to field the ball and you have an umpire ahead.
- Be ready to help the plate umpire on a ball near the dead-ball line on the first-base side of the field if the plate umpire must move to third base for a play.
- Stay outside the diamond when the ball is hit to left or center field whether the third-base umpire chases or not.

Starting Counter Rotated

- Choose a position not closer than 15 feet from first or second base.
- Base your choice of position on the location of the runners, the probability of a steal or a pickoff, the current game situation, and your knowledge of the offense and defense.
- On an infield hit, wait until the fielder commits on a play then move toward that base and be set prior to any action. Be set for both ends of a possible double play.
- Stay outside the diamond when the ball is hit to left or center field whether the third-base umpire chases or not.
- **If the ball is hit over your head into the outfield, strongly consider coming inside to keep all elements in front of you.**

◆ 7.6 Third-Base Umpire

Starting on the Line

- With no runners on and moving to a primary position at second base, stop/set and watch any play on the batter-runner at first base. Stop and wait until the U1 finishes the out signal on the runner before starting back to your position on the line. Be prepared if needed to give help on runner's interference.
- When the BR is safe at first base, remain in the primary position at second base until the BR returns to first and the ball is in possession of the pitcher in the pitcher's circle. Then move to your next position.
- When starting on the line with U1 counter-rotated and not covering a fly ball, stay outside the diamond in foul territory.
- With a runner on third base, adjust your position to accommodate seeing your check swing responsibilities. Move farther off the line or closer to the line depending on the runners lead off.
- When there is a runner on third only and there is a hit that easily scores R3, move to a primary position at second base, verbally communicating to U1, "I have second base."
- When there is a runner starting on second only or third and second and there is a hit that will score R2, before moving, look to see what U1 is doing with the BR. If U1 is with the BR and coming toward second base, remain at third base. When the BR moves back toward first base U3 should run hard into the primary position at second base while communicating to U1, "I have second base."

Starting Rotated

- This position is uniquely dynamic and has its own guidelines. U3 will initially set up 10-18 feet from second base between the first and third baseline extended toward center field. Base your choice of position and depth on the probability of a steal, the current game situation including the count and number of outs, your secondary responsibility at first base, the position of the center fielder and your knowledge of the offense and defense (MechaniGram A). This starting position may change on a pitch by pitch basis, continue to evaluate it during the at bat.

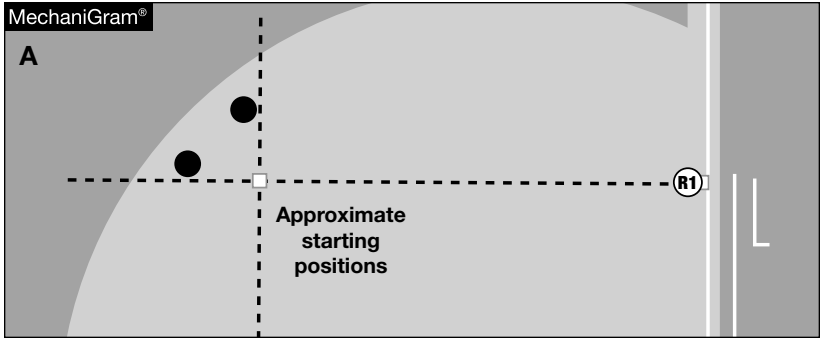

Classic Stolen Base Calling Positions

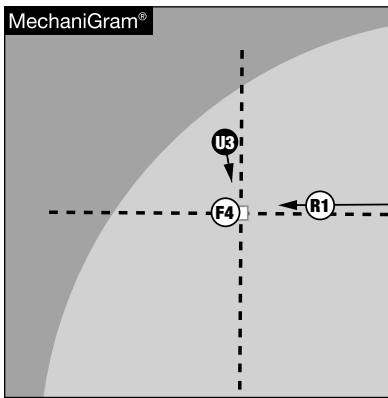

Fielder straddling, U3 starts on 1B side.

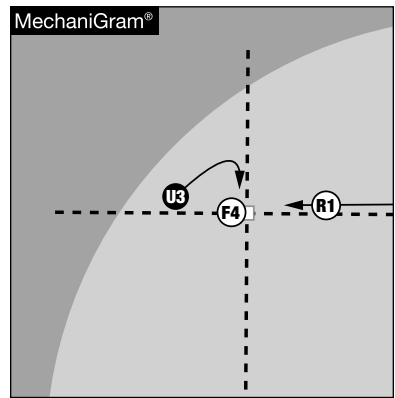

Fielder straddling, U3 starts on 3B side.

Wedge View Calling Positions

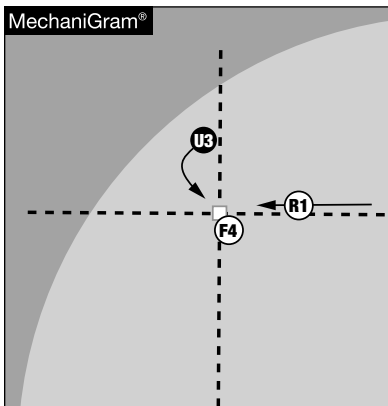

Fielder inside the diamond, U3 starts on 1B side.

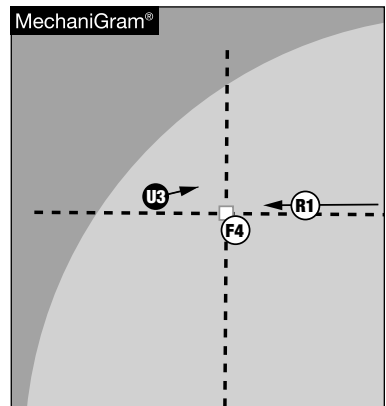

Fielder inside the diamond, U3 starts on 3B side.

- When a play develops, move from the starting position to a calling position. Remember that your starting position is rarely the best calling position, be prepared to move and adjust with the play. NOTE: A straight-line from 1B through 2B is RARELY a legitimate calling position.
- When the ball is hit to any fielder for a possible force at second base, stay outside the diamond and obtain force depth and move left or right accordingly to get the best angle on the throw.
- On tag plays when the defender is straddling the base move to the classic position to see the leading edge and the tag. On tag plays when the defender is inside or outside the baseline use the wedge view to watch all elements of the play.
- Be aware of the need to cover third base if the Plate Umpire's responsibilities keep them from committing to third base.

◆ 7.7 Situational Mechanics

Situations could arise in any game that would cause an umpire to deviate from the standard mechanics. Every mechanic cannot be covered in this manual. Umpires should read the play and adjust to the changing situations as they arise. This is the part of umpiring that allows you to adapt to each individual play situation as necessary.

The following are approved situational mechanics.

- U3 or U1 is on the line. The batter hits the ball, which is a line drive that moves quickly through the infield near the line and lands in front of the outfielder. U3 or U1 can make a fair-ball call, then continue three-umpire mechanics.
- With a 3-2 count and two outs, all umpires may move to force-play calling depth, as all potential tag plays have been eliminated.
- U1 is counter-rotated. The batter hits a fly ball that is near the line. U1 should chase on a possible trap near the line. The plate umpire has fair or foul responsibility and U1 determines catch/no catch.
- U3 is rotated. The batter bunts or bats a ball that rolls slowly near the foul line, requiring P to stay with the ball longer than usual to determine fair/foul. U3 must be prepared to take R1 to 3B for a possible play. If this happens U3 should communicate they have 3B. P stays at home and U1 would be responsible for any plays on the batter runner at 1B and 2B.

Standard Signals

Signals are the most important form of umpire communication. Information is relayed to the players, coaches, and spectators by their use. Signals should only vary in emphasis, not in implementation. From the routine play to the sell call to the unusual, every signal must be visible, distinct, strong, informative, and meaningful from its beginning to its end. Poorly executed and non-standard signals serve only to confuse everyone, including your partner. All signals worth giving are worth being given correctly.

NCAA umpires are expected to understand and use the signals presented in this manual. It is acceptable for crews to develop additional umpire-to-umpire signals to enhance communication. For example, if a crew feels like it is important to remind each other of the number of outs during an infield fly situation, the crew might give the infield fly situation signal as published, but then follow it up with the number of outs. The SUP prefers that standard signals not be modified but may be used in conjunction with other clear gestures as defined by the crew.

- Every signal should be initiated from a stopped, set or ready position. The feet are planted in a solid base, at least shoulder-width apart.
- Signals must always be presented with confidence and strength. Everyone who sees the signal should understand its message.
- Any movement while giving a signal is always toward the play.
- The signal must be held long enough to convey the conviction of the decision, and then the arms and hands are brought back into the body, thus completing the signal, before moving to the next position.
- Do not draw attention to yourself by overusing or needlessly using any signal. A call or signal is needed only when there is a play.
- All outs need to be signaled.

Here are some examples of when a signal is not needed:

- A hit ball clearly goes over the fielder's head or bounces in front of the closest defender.
- A hit ball that is fouled directly back to the backstop or fouled over the backstop or over the sides of the backstop.
- A ball that is overthrown or completely missed by the intended receiver.
- On a play where a runner clearly obtains any base or home plate before the ball arrives.
- When the batter is getting set, the pitcher is showing no indication of quick pitching.

◆ 8.1 Standard Umpire Signals



Out

Extend the right arm straight up with an open palm facing the ear, then bring the forearm slightly forward while clenching the hand into a fist, this is the Hammer. The right upper arm and forearm should both be at a 90-degree angle or greater. Verbally call "Out" if appropriate. Control the left arm by pulling it into the midsection of the body or against the body. **All outs need to be signaled.**

Sell Out

While moving at the play, bring the right arm even with or above the head somewhat like a throwing motion then bring it down toward the play with force while making a fist. A verbal call of "Out" (usually a drawn out, "Oooooutt") accompanies the signal, typically starting when the arm is by the head and finishing with the thrown fist. End in a balanced position facing the play. Maintain dignity and control of the body, feet and arms throughout the signal. **Sell outs may be used on close force plays, tag plays and diving catches.**



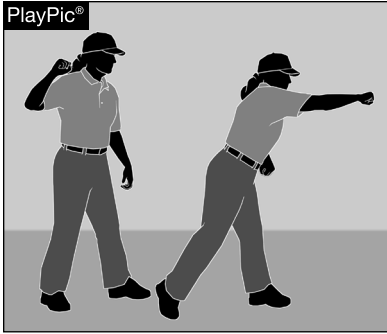

Punch Out

This is a variation of the Sell Out. It can be used to sell an out when you are too close to the play to do a full sell out, if a play warrants more than a routine out but less than a full sell out, or as a full-fledged sell out in its own right. To use a punch out that brings you no closer to the play, step back with the right foot and punch forward with the right arm. The

initial stepping back is overshadowed and compensated for by the strength and forward thrust of the punch. **Punch** outs may be used on close force plays, tag plays and diving catches.

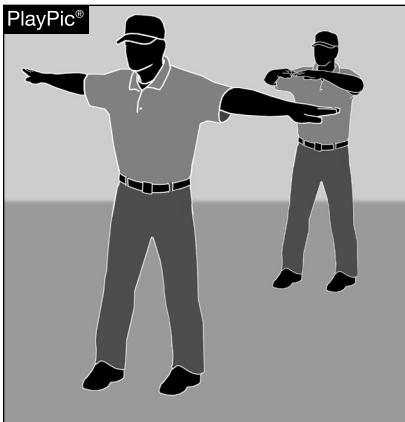

Safe, No Catch, No Tag,

No Infraction, That's Nothing

Bring both arms into the chest at shoulder level then immediately "Pop and Hold" this signal by extending both arms straight out horizontally with the palms down. Do not have your hands in fists. Verbally call "Safe," "No Catch," "No Tag," "That's Nothing/No Infraction," as is appropriate to the play. Do not allow the extended arms to snap back in front of your body. Finish the signal with a controlled release of the arms back

into the body. Do not just drop them before moving to the next position.

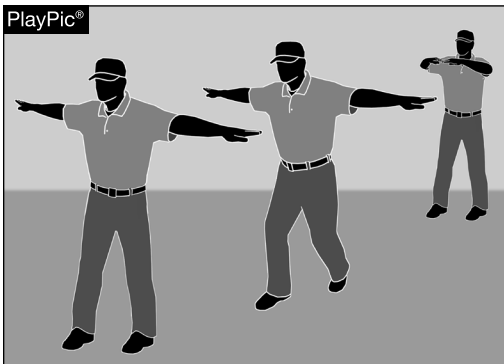

Sell Safe

Bring both arms into the chest at shoulder level, then immediately take a forward step at the play as you "Pop and Hold" this signal by extending both arms straight out horizontally with the palms down. Loudly call "Safe." Do not allow the extended arms to snap back in front of your

body. Finish the signal by bringing the back foot forward, even with the front one along with a controlled release of the arms back into the body.



Dead ball, Foul Ball, No Pitch, Time

Raise both arms straight up with palms forward. Arms should be at about a 35 to 40 degree angle from the body. Verbally call: "Dead Ball," "Foul Ball," "No Pitch," or "Time." Hold this signal until the call has been recognized and all action ceases. If the call is "Foul Ball" and the ball is close to the line, the feet should be straddling the line to finish the signal. When the plate umpire calls "No Pitch" or "Dead Ball", the signal may be accompanied by a sideward movement out from behind the plate for better visibility.

Dead Ball – Interference

Raise both arms straight up with palms forward. Arms should be at about a 35 to 40 degree angle from the body. Using a strong voice call "Dead Ball." Step in with authority, point to the runner and call them out for interference and return all runners back to the base they occupied at the time of the interference.

Note: If the batter-runner causes interference, the ball is dead from the time of the pitch.

Fair Ball

Extend the arm closest to the field horizontally at shoulder height and point over fair ground, with either the open hand palm forward, a finger or with the mask in hand. Do not crossover your body with the foul side arm. Do not make a verbal call. If the ball is hit near the foul line, move to a credible position straddling the line.



Infield Fly

Fully extend the right arm above the head with a point of index finger. Verbalize, "Infield fly. The batter is out." If the ball is close to a line say, "Infield fly. The batter is out, if fair." After completion of catch or rule of fair ball, verbalize, "The batter is out," signal an out. All umpires share concurrent authority to judge an infield fly and initiate the call. After any umpire calls the infield fly, all other umpires shall echo the signal.



Delayed Dead ball

Extend the left arm straight out at shoulder height, parallel to the ground. The hand is in a fist with the fingers of the fist facing forward. This signal is used to indicate illegally batted ball, batter interference, obstruction, illegal pitch and runner leaving the base too soon.



Strike

The “Called Strike” consists of a verbal and a signal. The verbal call for a “Called Strike” is made in the “down/set” position and should be immediately followed with the “strike” signal which is made in the “up” or “going to the up” position. To signal a “Strike”, extend the right arm straight up with an open palm facing the ear, then bring the right forearm slightly forward while clenching the hand into a fist (this is the Hammer). The right upper arm and forearm should be

at a 90-degree angle or greater. Control the left arm by pulling it into the midsection of the body or against the body. Do not move the feet during the signal. The signal is finished by bringing the right arm back into the body before stepping back or moving the feet.

NOTE: A “Swinging Strike” only has a signal (the Hammer) with no verbal. A “called third strike” signal differs from a called strike one or two because it is not only a strike, but is also an out. A more demonstrative signal and additional emphasis on the verbal is always used for a “called third strike.” Two popular styles are the bow-and-arrow/chainsaw and the overhand. The feet may move during this signal but the eyes, head and body must remain facing the plate area.



Third Strike Is Caught – Plate Umpire

When a third strike is swung at and missed or is called by the plate umpire, that umpire shall give the appropriate verbal call (if any) and strike signal. If there are fewer than two outs and first base is not occupied or there are two outs at the time of the third strike, the plate umpire must also judge a “catch/no catch” on that pitch by the catcher. If the pitch was judged “caught” but it is not obvious that the catcher caught the pitch or there is any confusion among the immediate participants, the plate umpire shall

verbally declare, “The batter is out” while giving an “out” signal to indicate that the pitch was judged to be “caught.”

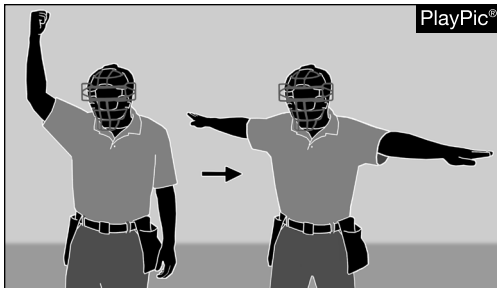

Third Strike Is Not Caught – Plate Umpire

When a third strike is swung at and missed or is called by the plate umpire, that umpire shall give the appropriate verbal call (if any) and strike signal. If there are fewer than two outs and first base is not

occupied or there are two outs at the time of the third strike, the plate umpire must also judge a “catch/no catch” on that pitch by the catcher. If the pitch was judged “not caught” but it is not obvious that the catcher did not catch the pitch or there is any confusion among the immediate participants, the plate umpire after giving the “strike” signal shall immediately give a standard “safe” signal and verbally announce “No catch” to indicate that the pitch was judged “not caught.”

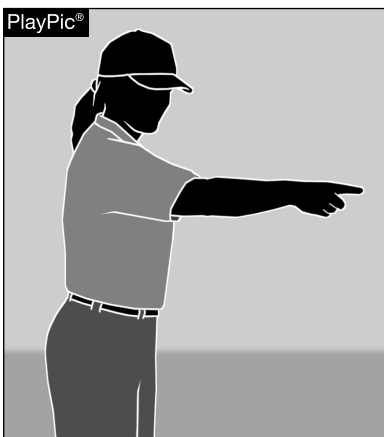

Point

The right or left arm extended straight out at a play or player. Only the index finger is extended on the hand. The other arm should be under control in close to the body. Use the Point to indicate or sell an abnormality in a play (e.g. a tag, a missed tag, a swing attempt) or to identify a player who committed a violation. The “Point” signal may be accompanied with a brief verbal explanation of the abnormality then is followed by another signal; either an “out,” “safe” or “strike.”



Home Run

Fully extend the right arm high above the head with the index finger pointed skyward and make a circling motion.

Double

Fully extend the right arm above the head with the index and middle finger pointed skyward. Do not circle the arm.





Play Ball

With the arm farthest from the batter extended toward the pitcher, the plate umpire may use a point or a beckoning motion with an open hand, to indicate the ball is in play. The signal may be accompanied with the verbal of “Play ball” or “Play.” The verbal call may be used without any signal.

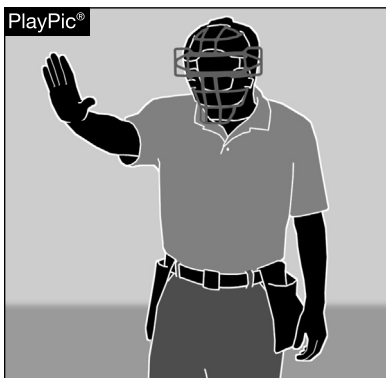

Do Not Pitch

With the arm farthest from the batter extended straight out with the palm of the hand facing the pitcher. Only use this signal when necessary to communicate with the pitcher – not routinely.

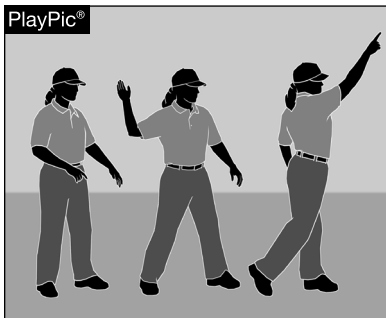

Ejection

While facing the person to be ejected, step back with one foot to open the body and allow it to turn away from the person. Bring an arm with the index finger extended up across the body and point skyward. The arm should be at a 45 degree angle to the body. You will be facing away from the ejected person. It is imperative when making this

signal that no aggressive move or gesture, real or perceived, is made toward the person being ejected. The signal should be moderately animated after increasing the physical distance between the umpire and the ejected person as needed. The degree of animation is dictated by the situation. This signal does not have to be exact, but it must be clearly understood that someone has been ejected.

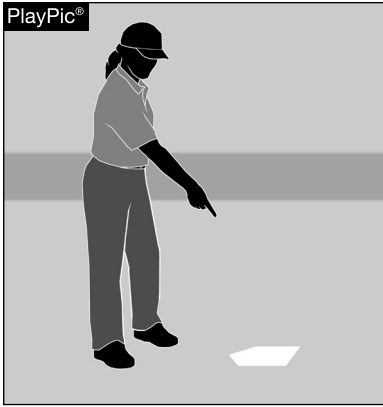

The Run Scores

Stand at the plate and emphatically point down at the plate while saying, "The run scores! Score the run!" Make sure the run goes up on the scoreboard. If necessary, use a deliberate pumping motion with the arm while pointing at the plate and repeat, "The run scores."



The Run Does Not Score

Stand at the plate. Raise both arms above the head like a foul ball signal. Cross the arms back and forth (not too quickly) while saying, "No run! The run does not score!" Watch the scoreboard to make sure a run is not recorded.



Foul Tip

This is an "optional" signal. It may be used every time the ball is a foul tip or used only at times when the ball being a tip is not completely obvious. Bring the left hand in front of your body, mid-chest

or higher, with the palm or back of the hand facing you. With an upward motion, brush or tap the fingers of that hand with the fingers of the right hand. This signal is always followed by a standard strike signal.



Count

Raise both arms up in front of the body at the same time so that your fingers are above your eyes. Balls are shown with the fingers of the left hand; strikes are shown with the fingers of the right hand. Consecutive fingers should be used in displaying the count. A verbal call may accompany the signal and, if used, should be as follows: "Two balls. Two strikes." Do not say: "Two and two." or "22." The count is given when the pitcher is facing home plate and held long enough for any other player to see it.



That's Ball Four

After signaling "Dead ball," remove your mask and raise the right arm with four fingers extended up in front of the body so the fingers are above the eyes. Accompany the signal with a verbal, "That's ball four." This signal should be used when the count is three balls and the batter would not have been awarded first base because of hit-by-pitch, but is awarded first base because of the count advancing to four balls.

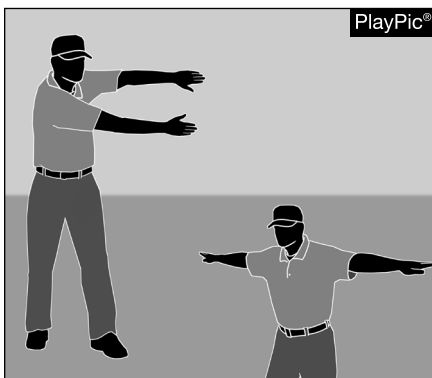

Off The Bag

This is an optional but extremely useful signal that explains why the call is being made. It is used in force play situations where the ball arrives before the runner, but the defensive player is not touching the base. Give this signal first, which may be accompanied with a verbal "Off the bag", followed by an emphatic safe signal.

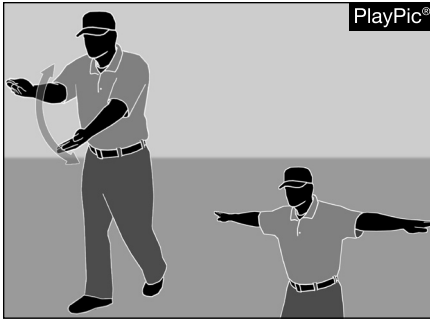

Bobbled Ball

This is an optional but extremely useful signal that explains why the call is being made. It is used in both force and tag play situations to indicate why the runner is not out. Give this signal first, which may be accompanied with a verbal “No control”, followed by an emphatic safe signal.



Spectator Interference

Fully extend both arms directly overhead to signal and verbally call “Dead ball.” Then with one hand, grasp the other wrist with your palms facing forward. The signal may be accompanied by movement towards the location of interference. Following the call, turn to the field and indicate the outcome of the interference (out, base awards, etc.). If necessary, consult with the crew before making awards and/or calling outs.

◆ 8.2 Umpire-to-Umpire Signals

Standard signals are used to convey information to everyone in the ballpark; umpire-to-umpire signals are meant to convey information between umpires. These signals are vital in establishing good crew communication.

- Umpire-to-umpire signals are initiated by the plate umpire. The most appropriate timing is just after putting your mask on — this allows more pre-pitch time for base umpires. It must happen prior to establishing a stance behind the catcher or the batter stepping into the batter's box.
- The base umpires must acknowledge by returning the same signal back to the plate umpire.
- The signal must be given before every new batter when the situation is in effect.



Infield Fly Situation Is On

The right hand, palm open, on the left chest indicates the “infield fly” situation is in effect. The signal may be followed by giving the number of outs if desired.

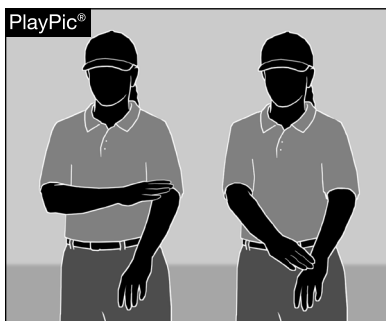

Infield Fly Situation Is Off

Use the right hand in a wiping motion on the left forearm from the elbow to the wrist indicates the infield fly situation is no longer in effect. It is acceptable to use the “two out indicator” to indicate that the infield fly is not in effect because there are two outs.



Third Strike is Not Caught – Base Umpires

Extend the right arm straight out from your side at a 45 degree angle. The index finger is pointing at the ground. This signal is used by the base umpires to indicate to the plate umpire that a third strike was not caught. If a third strike is obviously caught or dropped, there is no requirement to give a signal. However, if the batter is entitled to run and there is any question whether or not the third strike was caught, the base umpires shall give the signal to the plate umpire. If the batter is out by rule on a third strike, whether it is caught or not, do not use this signal.

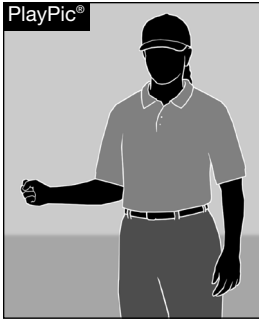

Third Strike is Caught – Base Umpires

The elbow of the right arm is held at the side of the waist with only the forearm extending out from the body in a 90-degree angle. The hand is clenched in a fist. This signal is used by the base umpires to indicate to the plate umpire that a third strike was caught. If a third strike is obviously caught or dropped, there is no requirement to give a signal. However, if the batter is entitled to run and there is any question whether or not the third strike was caught, the base umpires shall give the signal to the

plate umpire. If the batter is out by rule on a third strike, whether it is caught or not, do not use this signal.

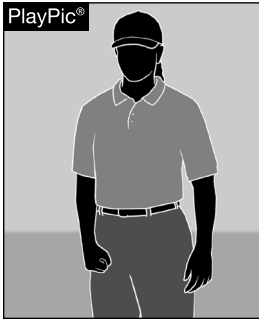

How Many Outs

To confirm the number of outs, the umpire looks to a partner and clenches a fist against the thigh. It is acceptable to verbalize the request, “Partner, how many outs do you have?” Do not allow play to resume if there is a discrepancy in the number of outs.

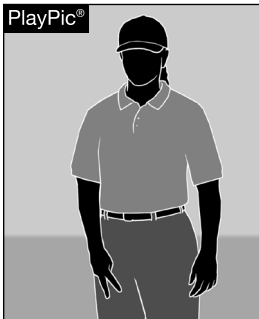

How Many Outs Response

The responding umpire should indicate the number of outs by putting the appropriate number of fingers against the thigh. If a verbal request is made, respond verbally in addition to displaying the outs. Do not allow play to resume if there is a discrepancy in the number of outs.



Timing Play Indicator

This signal is used when a timing play scenario is in play. Two outs with a runner on first or second (other bases may also be occupied.) The signal is two fingers on the left wrist. Base umpires return the signal.

PlayPic®

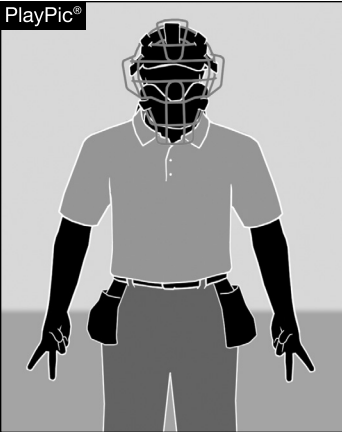

Two Out Indicator

This signal is used with two outs and no baserunners on second or first. Hold both arms out at waist level with two fingers. The base umpires should acknowledge by returning the signal with one hand.

PlayPic®



What is the Count?

To request the count from a partner, place both opened hands against the chest. It is acceptable to verbalize the request, "Partner, what count do you have?" Do not allow play to resume if there is a discrepancy in the count.

PlayPic®



What Is the Count Response

The responding umpire should indicate the correct count by displaying the appropriate fingers on the chest. If a verbal request is made, respond verbally in addition to displaying the count. Do not allow play to resume if there is a discrepancy in the count.



Checked Swing Request

The plate umpire by rule if asked to get help or if there is any doubt about a swing attempt shall ask the appropriate base umpire for help. Obtain an unobstructed view of the base umpire and point to them with either arm. Use your partner's first name to aid in getting their attention then ask, "Did they go?", "Was there a swing?", "Do you have an attempt/offer?", "Swing?", etc. If the count has three balls and/or two strikes, ask your partner for help quickly prior to the defense requesting to maintain game flow. If the response is "yes", do not echo the decision with a strike signal. Upon returning to the plate area, give the count.



Checked Swing Response – Yes

Upon completion of the checked swing request by the plate umpire, if judged that the batter attempted to hit or bunt the ball and was unable stop the attempt, the base umpire's reply is "Yes!" accompanied by a "strike" signal.

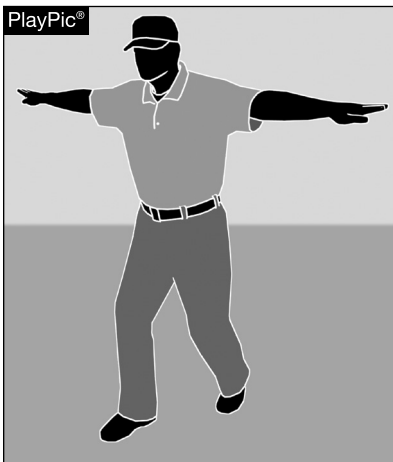

Checked Swing Response – No

Upon completion of the checked swing request by the plate umpire, if judged that the batter did not attempt to hit or bunt the ball and was able to stop the attempt, the base umpire's reply is "NO!" accompanied by a "safe" signal.

3-PERSON MECHANICS

KEY



Plate umpire



First base umpire



Third base umpire



Judgment point



Judgment point



Judgment point



Runner on first



Runner on second



Runner on third



Batter runner

Ball movement

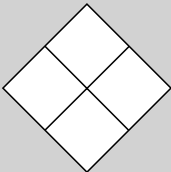

No runners on

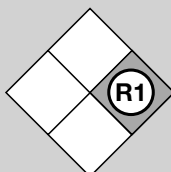

Runner on first

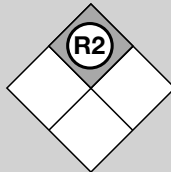

Runner on second

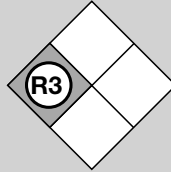

Runner on third

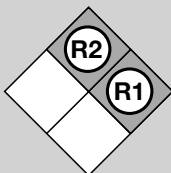

Runners on first
and second

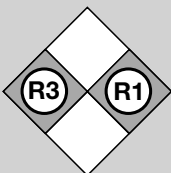

Runners on first
and third

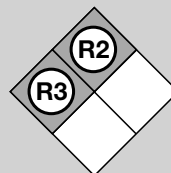

Runners on
second and third

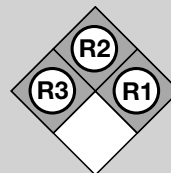

Bases Loaded

Section

9

Three-Umpire System

Umpires must have a thorough awareness and understanding of the responsibilities and expectations of, not only the position they are working, but all positions. If each umpire does their job as expected, play coverage will be flawless. Umpires are expected to use the standard starting positions, areas of coverage and rotations, and to employ, at all times, the core philosophy of general mechanics when working this system. Any deviation or adjustment from the standard will be dictated by the action on the field and must be communicated among the crew umpires at that time.

The System

The following MechaniGrams in this section illustrate multiple situations for each of the eight (8) possible runner configurations. The MechaniGrams show general areas of positioning and not exact spots. Umpires are expected to utilize optimum positioning for all situations. The text describes the expectations, responsibilities and duties for each umpire in each of the situations. Each member of the crew must be aware of the responsibilities of each umpire in each of the situations.

Runner Configurations

- No runners on
- Runner on first base only
- Runner on second base only
- Runner on third base only
- Runners on first and second base
- Runners on first and third base
- Runners on second and third base
- Bases loaded





No Runners on Base “Standard” Starting Position

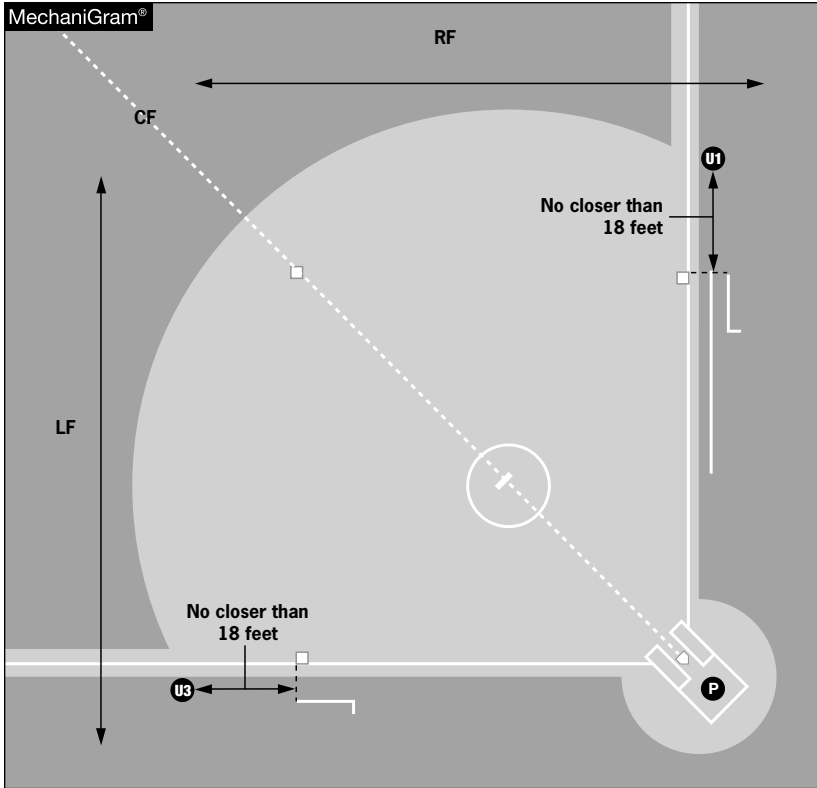

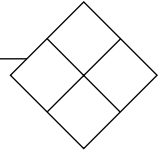

- P: Checked Swing** – Request help from the open umpire on the line.
Fly Ball Coverage Area – When no base umpire chases, the plate umpire is responsible for all fly balls.
- U1: Before the pitch** - Start no closer than 18 feet beyond first base and within a foot of the line, completely in foul territory either standing upright or in a set position.
On the pitch - Stay in a set position or move forward a maximum of two steps facing home plate, ending in a prepared set or stopped position as the pitch reaches the front of the plate.
Checked Swing – Right-handed batters.
Fly Ball Coverage Area - Center fielder to the right field dead ball line. U1 has the right of first refusal on balls hit to the center fielder.
- U3: Before the pitch** - Start no closer than 18 feet beyond third base and within a foot of the line, completely in foul territory either standing upright or in a set position.
On the pitch – Stay in a set position or move forward a maximum of two steps, facing home plate, ending in a prepared set or stopped position as the pitch reaches the front of the plate, or be in a set position on the pitch release.
Checked Swing – Left-handed batters.
Fly Ball Coverage Area - Center fielder to the left field dead ball line.



No Runners on Base Hit to the Infield

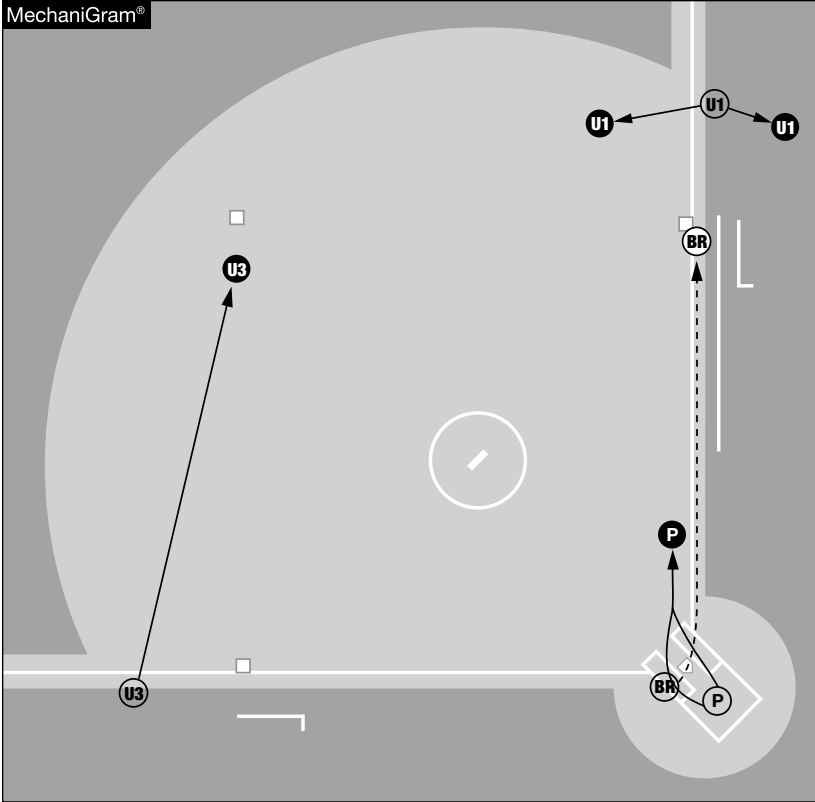

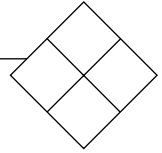

- P:** • On a throw to first base, trail the BR in fair territory no more than 15 feet up the line, coming to a complete stop prior to the play.
- U1:** • Move into fair or foul territory to make all calls at first base on the BR.
- U3:** • Move straight into the diamond to a primary position for a tag play at second base.



No Runners on Base

Foul Fly Ball to the Infield Area

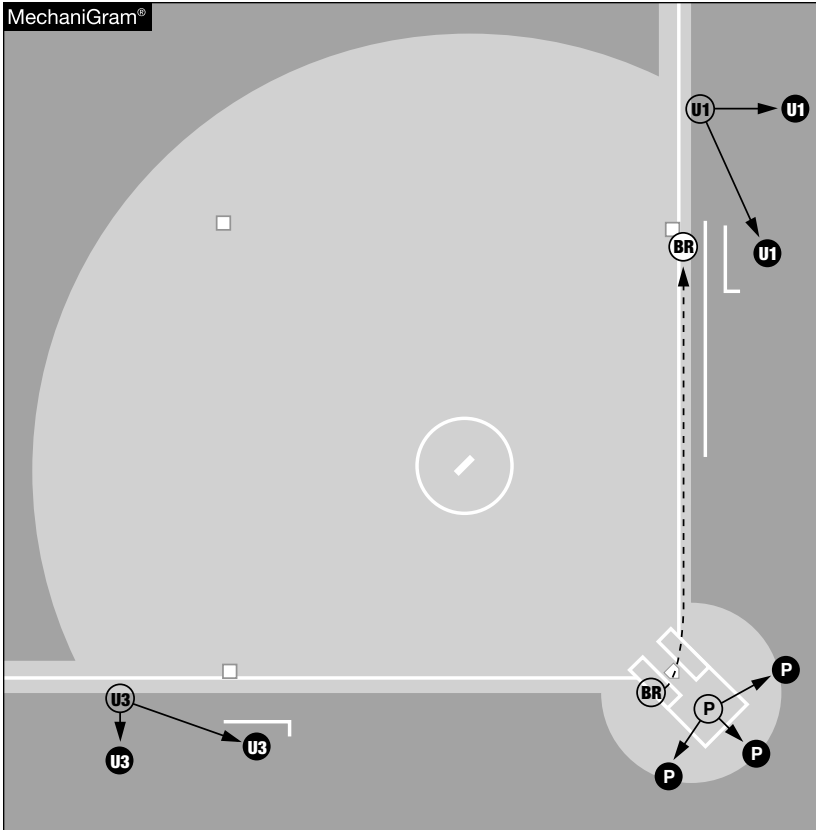

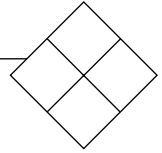

- P:**
- Once the ball is hit, read the catcher. Allow the catcher to take you to the ball.
 - Close-down the distance to the play if the infielders are diving, the ball is against the fence or near the dugout area.
 - When a base umpire is bracketing the play, make the call on the catch/no catch if the play is facing you, the field or the dugout. Otherwise, the base umpire who the play is facing will make the call.
 - The responsibility for the catch/no catch belongs to the plate umpire, if the catch is not facing either umpire.
- U1:**
- When the fly ball is on the first base side, move into foul territory to bracket the play with the plate umpire.
 - Close-down the distance to the play if the infielders are diving, the ball is against the fence or near the dugout area.
 - Make the call on the catch/no catch if the play is facing you. Otherwise, the plate umpire will make the call.
- U3:**
- When the fly ball is on the third base side, move into foul territory to bracket the play with the plate umpire.
 - Close-down the distance to the play if the infielders are diving, the ball is against the fence or near the dugout area.
 - Make the call on the catch/no catch if the play is facing you. Otherwise, the plate umpire will make the call.



No Runners on Base

No Chase – Fly Ball/Line Drive –
Ball is Caught

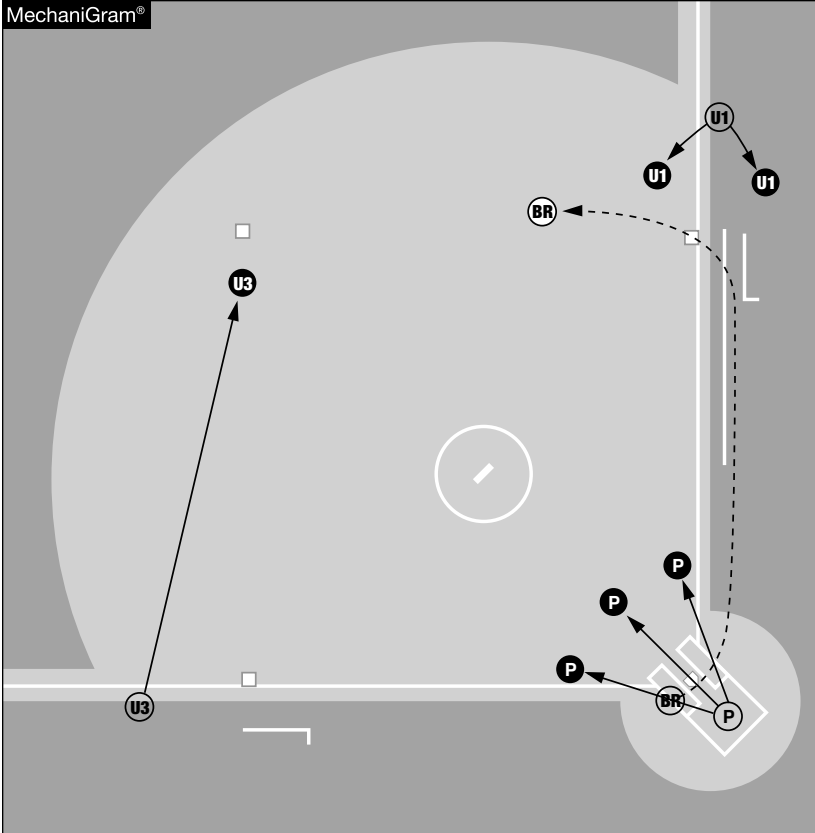

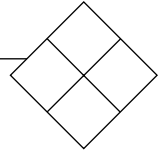

P: • Move into the infield in the direction of the ball.

U1: • Move into fair or foul territory to make all calls at first base on the BR.

U3: • Move straight into the diamond to a primary position for a tag play at second base.



No Runners on Base No Chase - Ball is Not Caught

MechaniGram®

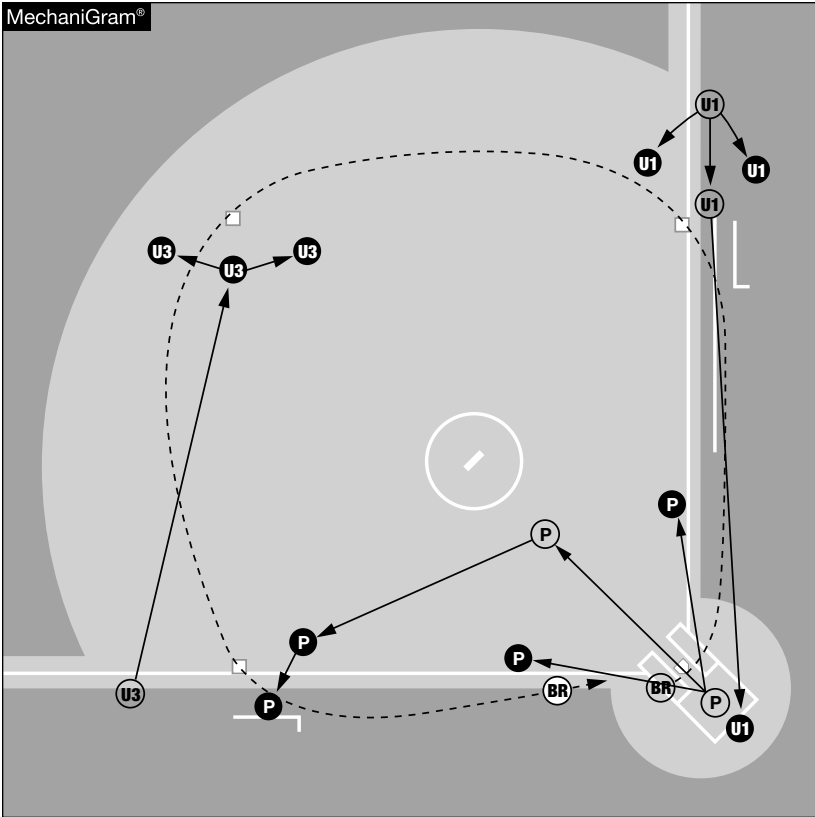

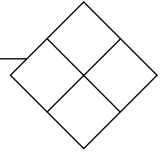

- P:**
- Move into the infield in the direction of the flight of the ball.
 - If the BR advances to second base, move to a primary position for a tag play at third base.
 - Make all calls at third base.
- U1:**
- Move into fair or foul territory to make all calls at first base.
 - If the BR advances to second base, move up into the baseline in either fair or foul territory.
 - If the BR advances to third, mirror the advancement by moving all the way to the point of the plate holding area.
 - Make all calls at home plate.
- U3:**
- Move straight into the diamond to a primary position for a tag play at second base.
 - Make all calls at second base.



No Runners on Base

No Chase - Home Run (Out-of-the-Park)

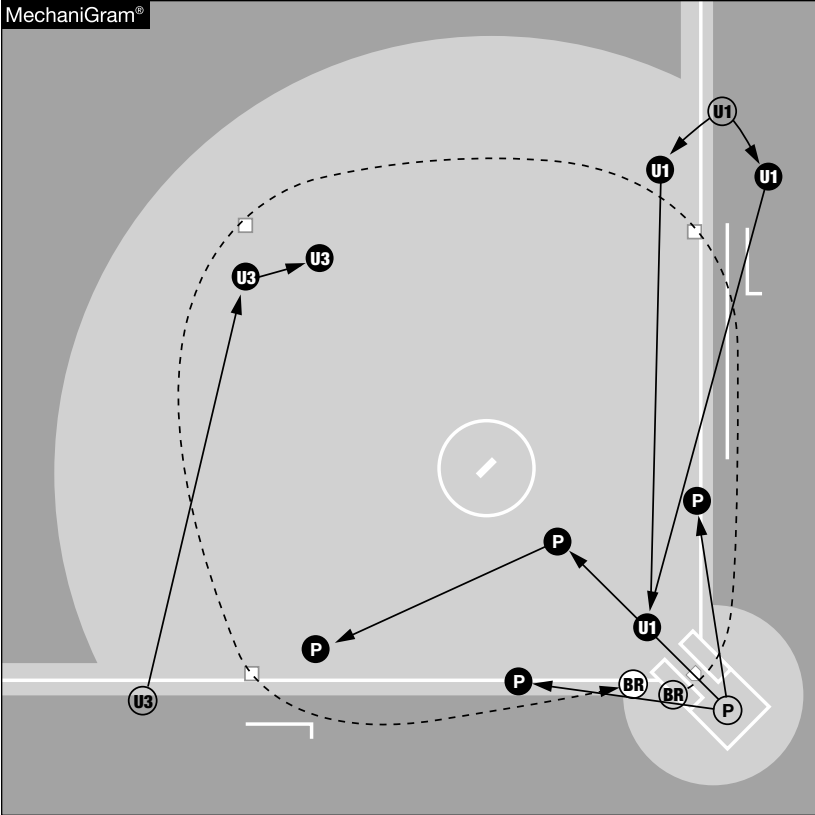

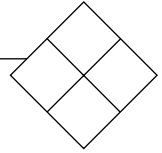

- P:**
- Move into the infield in the direction of the flight of the ball.
 - After signaling home run, move to a primary position near third base, watch the BR touch third base.
 - After the BR touches home plate, give a ball to the pitcher, catcher or closest infielder.
- U1:**
- Watch the BR touch first base.
 - Move to an infield position in front of home plate.
 - Make all calls at home plate.
- U3:**
- Move straight into the diamond to a primary position.
 - Watch the BR touch second base.



No Runners on Base

U1 Chases - Ball is Caught

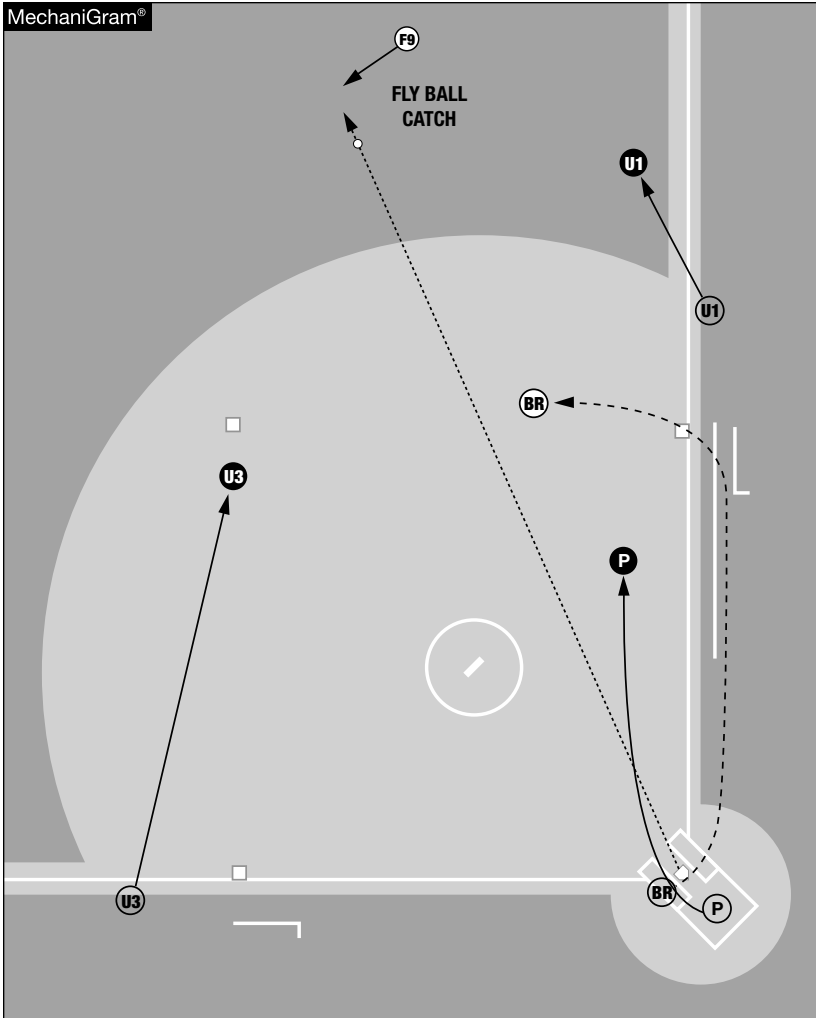

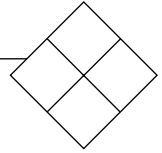

- P:**
- Move to a primary/credible position for a possible force play at first base.
 - Make all calls at first base.
- U3:**
- Move straight into the diamond to a primary position for a tag play at second base.



No Runners on Base

U1 Chases - Ball is Not Caught

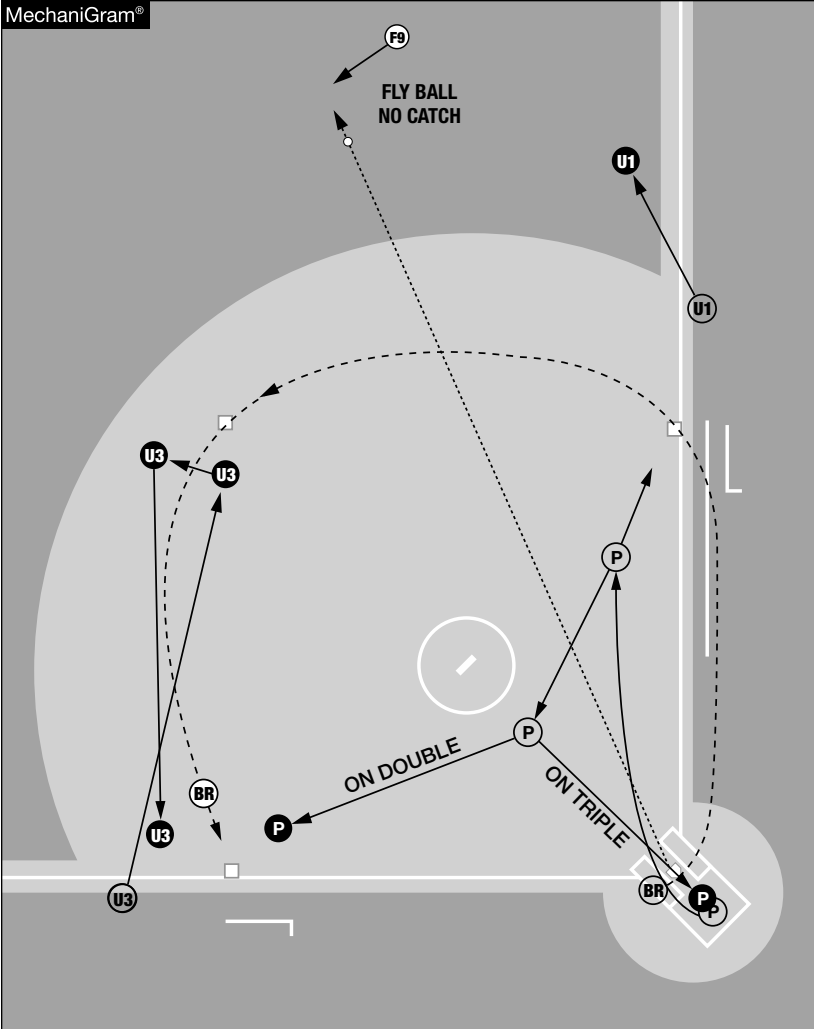

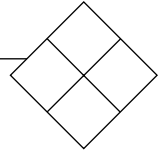

- P:**
- Move to a primary/credible position at first base.
 - Make all calls at first base.
 - If the BR approaches second base, move to the front of the circle.
 - If the BR slows down and/or stops at second base, move to third base and take any subsequent play at third base or home.
 - If there is no breakdown and the BR advances to third base, move to the point of the plate.
 - Make all calls at home plate.
- U3:**
- Move straight into the diamond to a primary position for a tag play at second base.
 - Make all calls at second base.
 - If the BR doesn't slow down, move back to third base arriving before the BR in position to make all calls at third base.



No Runners on Base

U1 Chases - Home Run (Out-of-the-Park)

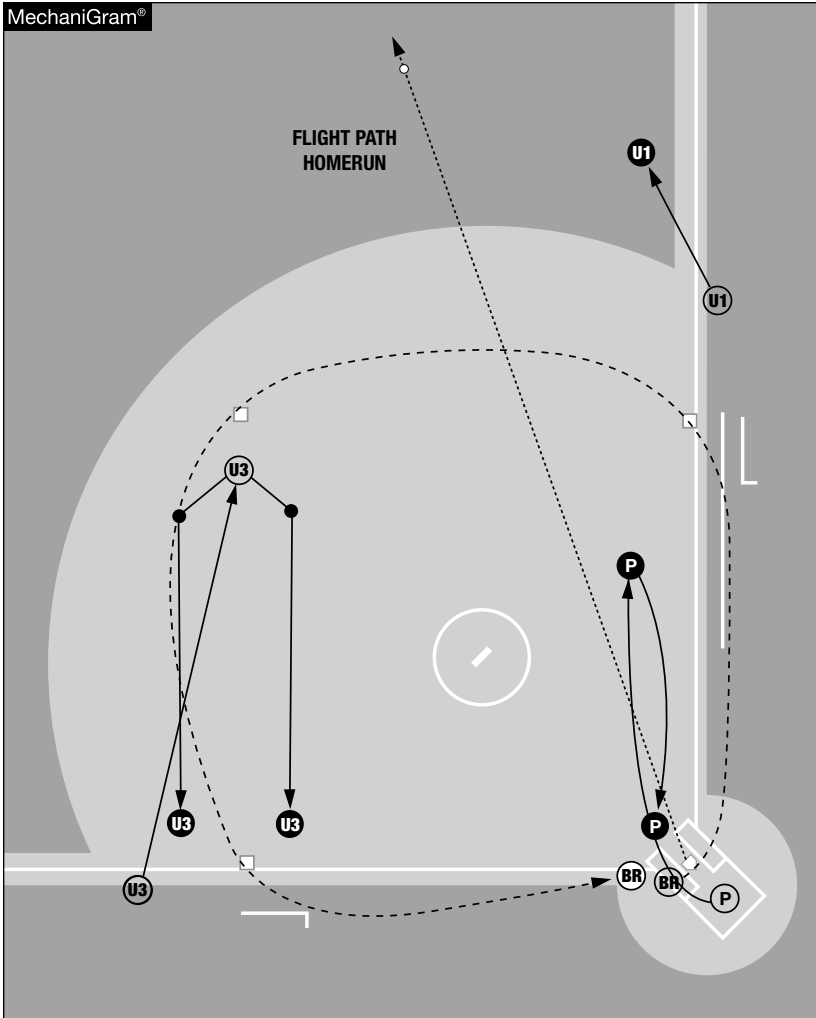

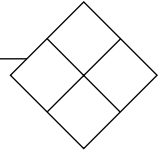

- P:**
- Move to a primary position at first base to watch the BR touch first base.
 - After the home run signal, move to an infield position in front of home plate.
 - Make all calls at home plate.
 - After the BR touches home plate, give a ball to the pitcher, catcher or closest infielder.
- U3:**
- Move straight into the diamond to a primary position for a tag play at second base.
 - Watch the BR touch second base.
 - Move along with the BR inside or outside the diamond.
 - Watch the BR touch third base.



No Runners on Base

U3 Chases - Ball is Caught

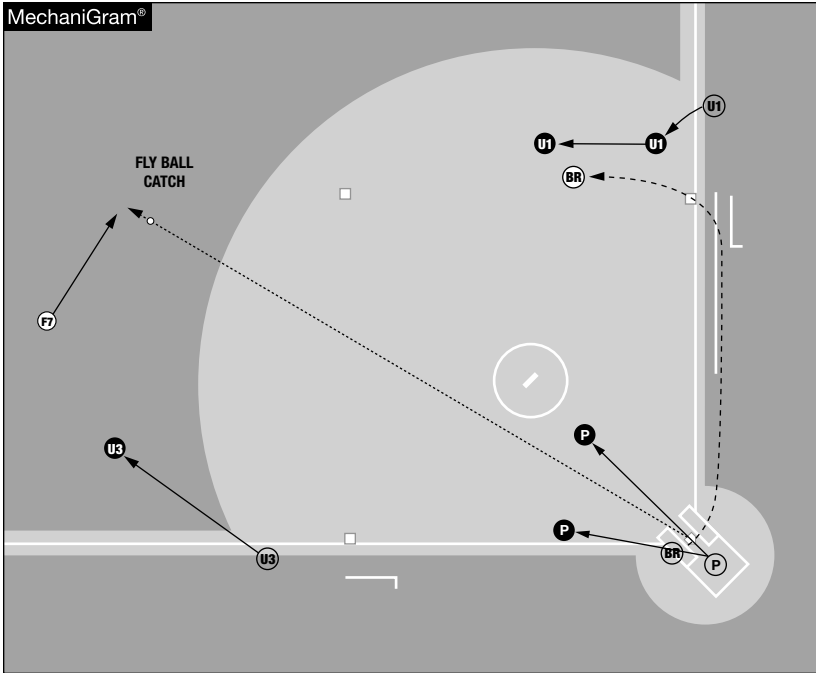

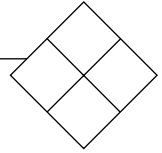

P: • Move into the infield in the direction of the flight of the ball.

U1: • Move into fair territory staying outside the diamond.
• Make all calls at first base.



No Runners on Base

U3 Chases - Ball is Not Caught

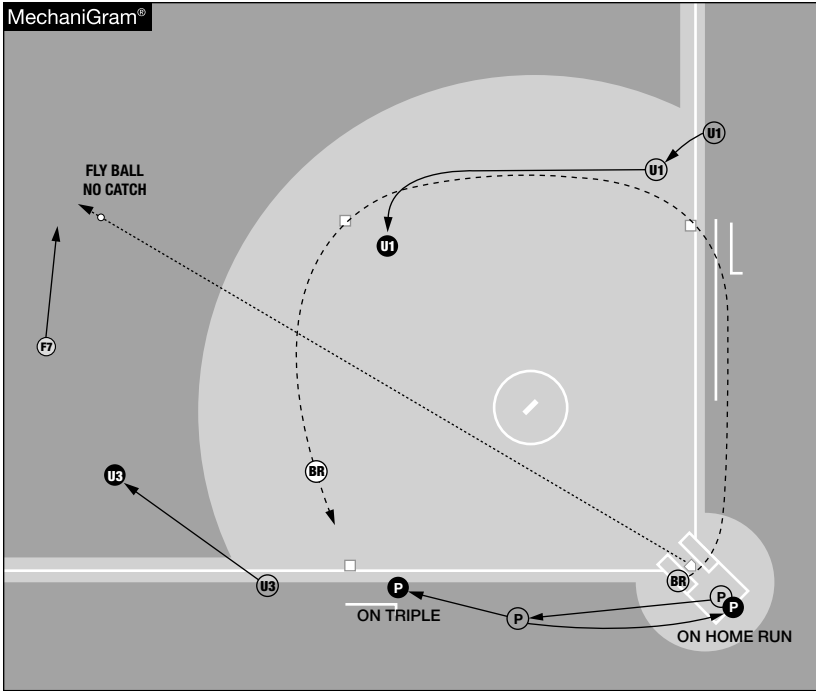

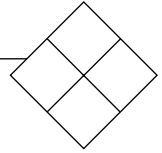

- P:**
- Move into the infield in the direction of the flight of the ball.
 - When the ball is declared no catch, move into the holding area between home plate and third base.
 - Do not commit to third base unless a play is imminent.
 - Make all calls at third base and home plate.
- U1:**
- Move into fair territory outside the diamond, make all calls at first and second base.
 - As the BR approaches second base with the ball still in the outfield, move inside the diamond behind the BR, visually confirm that the plate umpire is prepared to take the BR at third base.



No Runners on Base

U3 Chases - Home Run (Out-of-the-Park)

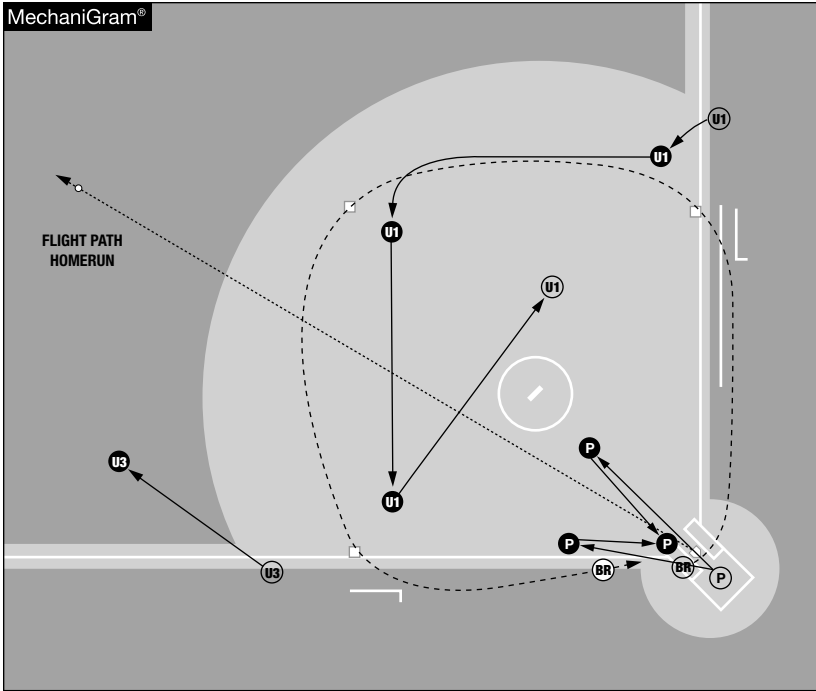

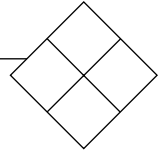

- P:**
- Move into the infield in the direction of the flight of the ball.
 - After the home run signal, move to an infield position in front of home plate.
 - Make all calls at home plate.
 - After the BR touches home plate, give a ball to the pitcher, catcher or closest infielder.
- U1:**
- Move into fair territory staying outside the diamond and watch the BR touch first base.
 - As the BR is approaching second base, move inside the diamond behind the BR.
 - Watch the BR touch second and third base.
 - While watching the BR continue to home plate, jog diagonally across the field heading to the next starting position.



Runner on First "Rotated" Starting Position

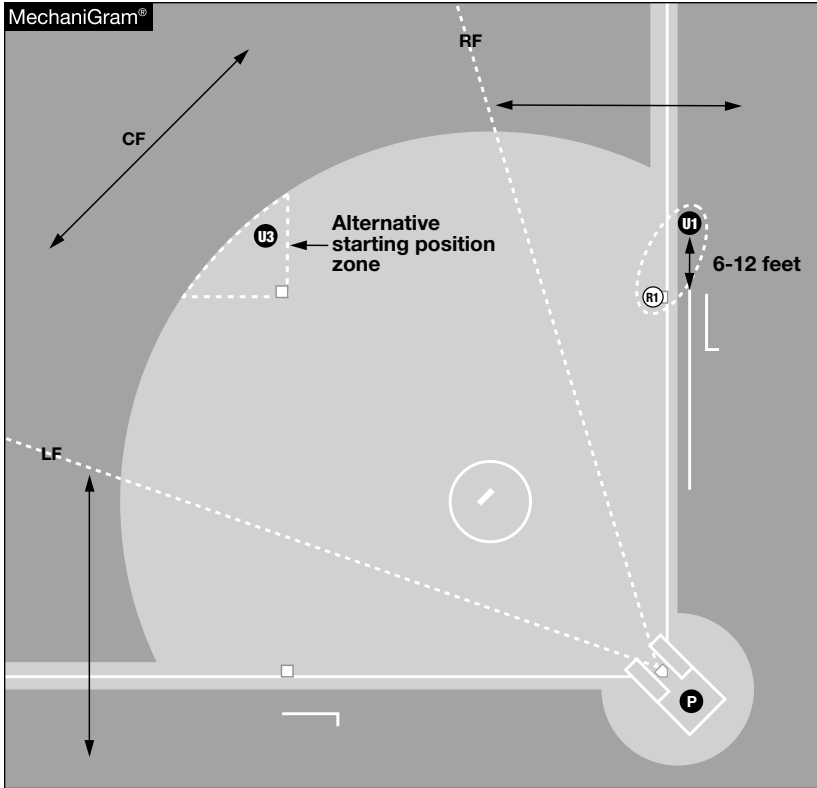

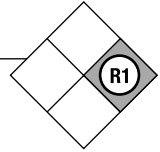

P: Checked Swing – U1.

Fly Ball Coverage Area – Left fielder to the left field dead ball line. When no umpire chases, all fly balls.

Tag Up Responsibilities – R1 when U1 chases with less than two outs.

U1: Before the pitch - Start in a set position, slightly angled towards the infield (opposite baseline between home and third base), completely in foul territory, within a foot of the line, 6-12 feet beyond first base.

On the pitch - Responsible for watching R1 for leaving the base before the pitch is released.

Checked Swing – All batters.

Fly Ball Coverage Area – Right fielder to the right field dead ball line. U1 has the right of first refusal on balls hit to the right fielder.

Tag Up Responsibilities – R1 when no umpire chases or U3 chases.

U3: Before the pitch – Start in a set position, squared to home plate, 10-18 feet from second base between the first and third baseline extended.

On the pitch - No runner responsibilities.

Checked Swing – None.

Fly Ball Coverage Area – The “V” from the left fielder to the right fielder.

Tag Up Responsibilities – None.





Runner on First

Hit to the Infield

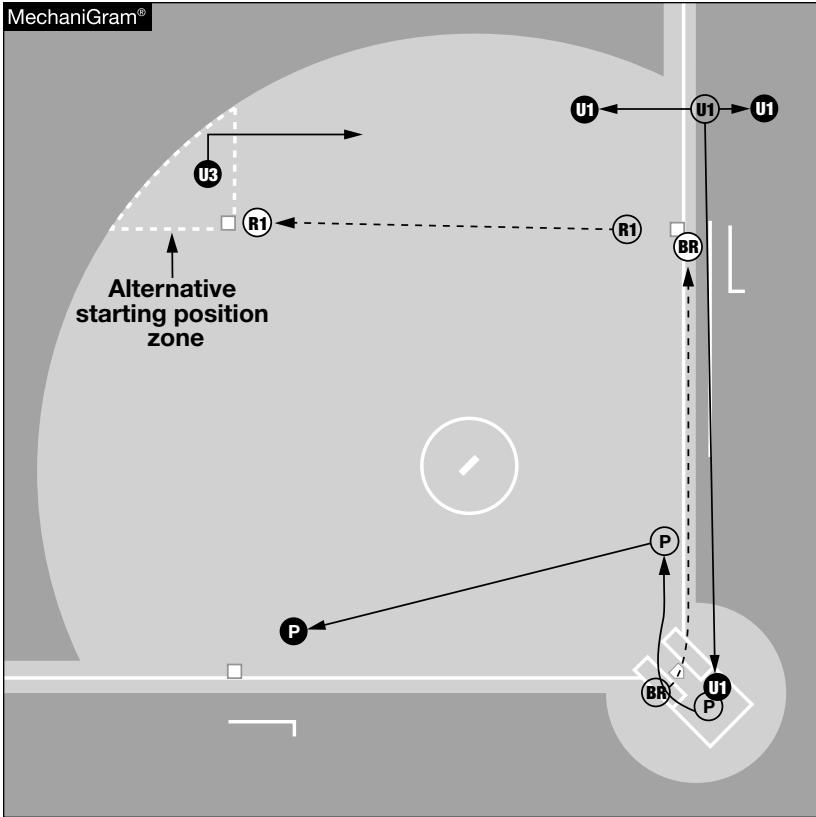

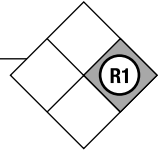

- P:**
- On a throw to first base, trail the runner in fair territory no more than 10 feet up the line.
 - With no throw to first base, move into the infield towards the front of the circle.
 - If R1 approaches second base move to a primary position for a tag play at third base.
- U1:**
- Move into fair or foul territory to make all calls at first base on the BR.
 - If R1 advances to third base, mirror the advancement by moving all the way to the point of plate holding area. Communicate with U3 and the PU on the advancement. Make all calls at home plate on R1 and the BR.
 - **If there is a high potential for a play on the BR at first base, stay with the play until U3 can take over the responsibility. If U1 is unable to rotate home, communicate with both the plate umpire and U3 that you are pinned at first base.**
- U3:**
- Make all calls at second base.
 - If R1 advances to third base and the plate umpire is unable to leave their responsibilities, be prepared to take R1 to third base.
 - If R1 advances to third base and the BR is not out, move to take over responsibility of the BR and make all calls at first or second base. Communicate to U1 that you have the BR.



Runner on First

Foul Fly Ball to the Infield Area

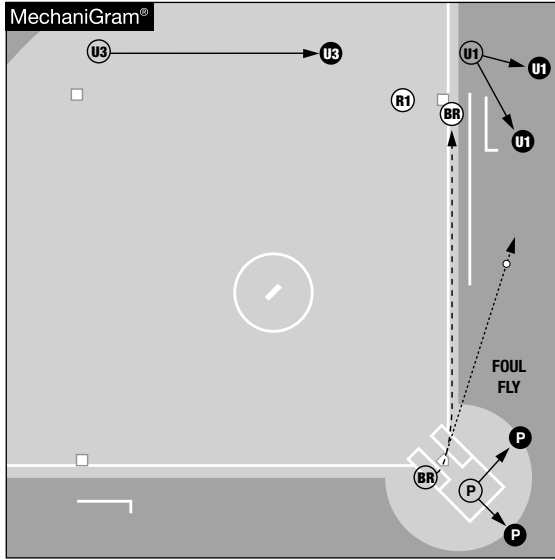

Pop Up – First Base Side

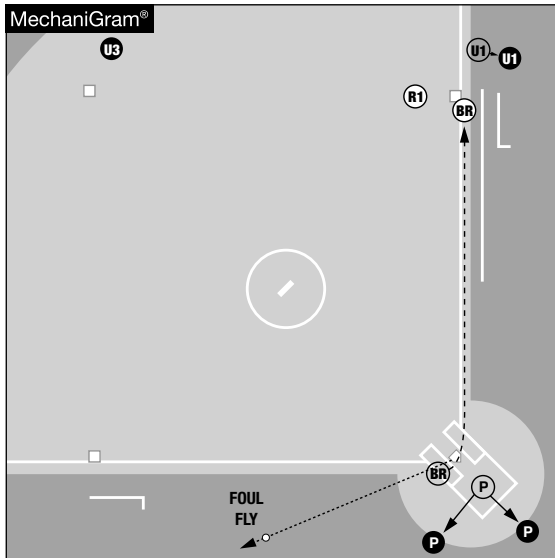

Pop Up – Third Base Side

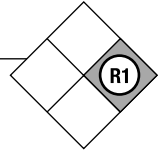

- P:**
- Once the ball is hit, read the catcher. Allow the catcher to take you to the ball.
 - Open pivot to the catcher's back creating room for the catcher to go to the ball.
 - Close-down the distance to the play if the infielders are diving, the ball is against the fence or near the dugout area.
 - If U1 is bracketing on the first base side, make the call on the catch/no catch if the play is facing you, the field or the dugout. Otherwise, U1 will make the call, if the play is facing them.
 - The responsibility for the catch/no catch belongs to the plate umpire, if the catch is not facing either umpire.
- U1:**
- When the pop-up is on the first base side, move into foul territory to bracket the play with the plate umpire.
 - Communicate with U3 to come make any call on R1.
 - Close-down the distance to the play if the infielders are diving, the ball is against the fence or near the dugout area.
 - Make the call on the catch/no catch if the play is facing you. Otherwise, the plate umpire will make the call.
- U3:**
- When the pop-up is on the third base side, stay at second base.
 - When the pop-up is on the first base side and U1 moves to bracket the ball with the plate umpire, seek a position to see R1 tag up and communicate with U1. Watch R1 return and make any call at first base.



Runner on First

No Chase - Fly Ball/Line Drive - Ball is Caught

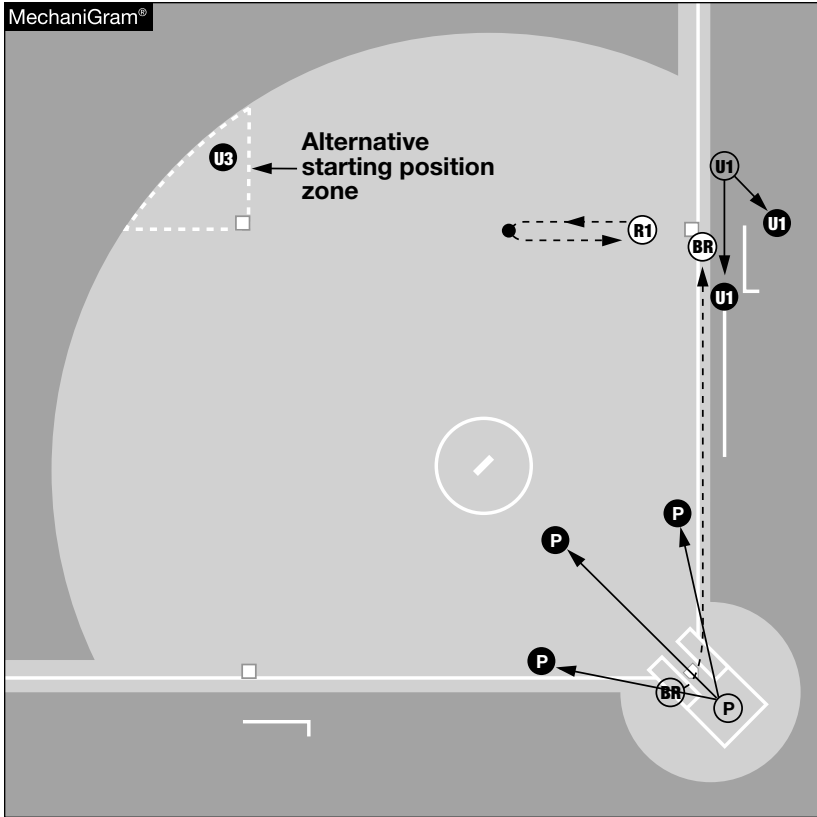

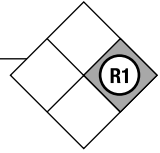

- P:** • Move into the infield in the direction of the flight of the ball.
- U1:** • Move into fair or foul territory to align yourself with the ball and R1 to watch the tag up.
• Make all calls at first base.
- U3:** • Make all calls at second base.

Runner on First

No Chase - Ball is Not Caught

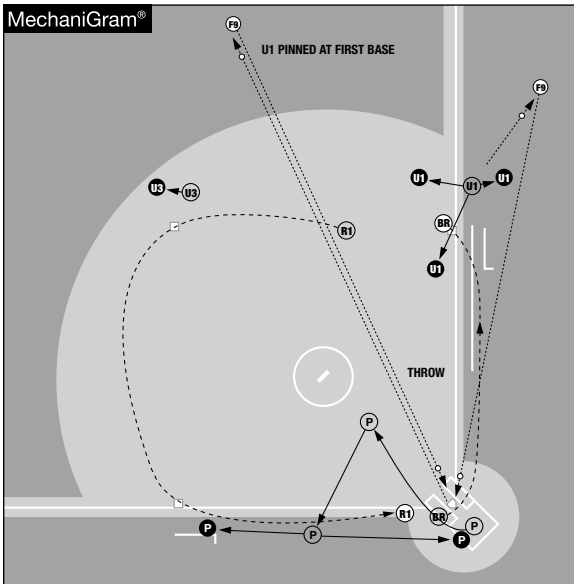
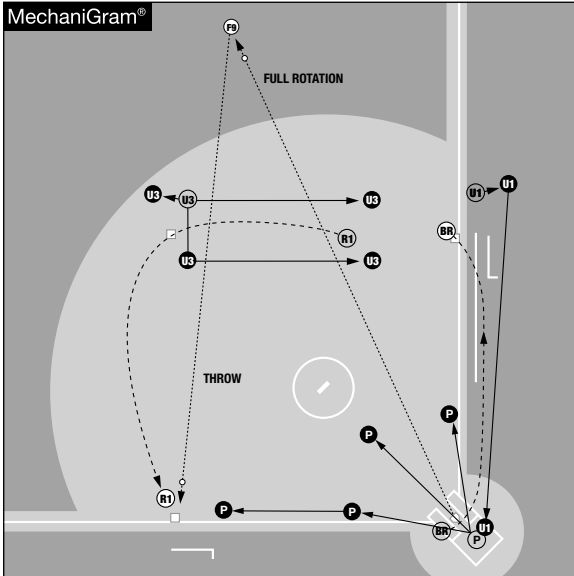

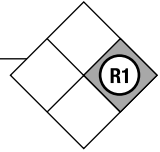

- P:**
- Move into the infield in the direction of the flight of the ball.
 - As R1 advances to second base, move to a primary position for a tag play at third base.
 - Make all calls at third base.
 - **If U1 is unable to rotate home, move to the holding area in foul territory between third base and home plate. Be prepared to make all calls at third base or home plate.**
- U1:**
- Move into fair or foul territory to make all calls at first base on the BR.
 - If R1 advances to third base, mirror the advancement by moving all the way to the point of plate holding area. Communicate with U3 and the PU on the advancement.
 - Make all calls at home plate.
 - **If there is a high potential for a play on the BR at first base, stay with the play until U3 can take over the responsibility. If U1 is unable to rotate home, communicate with both the plate umpire and U3 that you are pinned at first base.**
- U3:**
- Make all calls at second base.
 - If R1 advances to third base, move to take over responsibility of the BR and make all calls at first or second base. Communicate to U1 that you have the BR.
 - **If U1 is unable to rotate home, be prepared to take any calls on the BR at second and third base**



Runner on First

No Chase - Home Run (Out-of-the-Park)

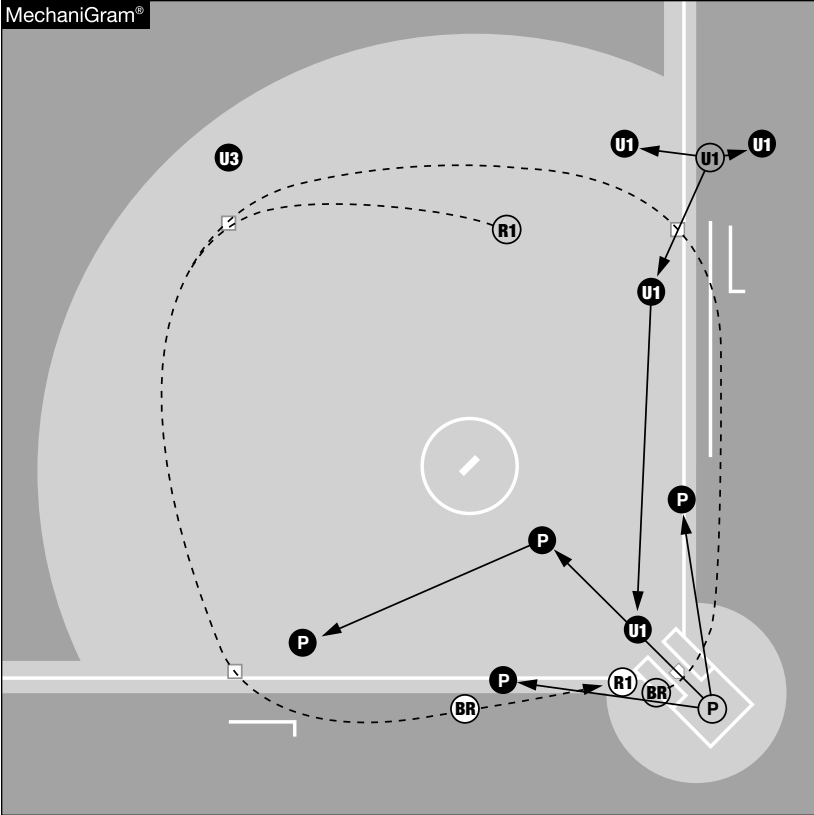

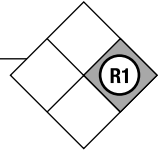

- P:**
- Move into the infield in the direction of the flight of the ball.
 - After signaling home run move to a primary position at third base. Watch R1 and BR touch third base.
 - After the BR touches home plate, give a ball to the pitcher, catcher or closest infielder.
- U1:**
- Watch the BR touch first base.
 - Move to an infield position in front of home plate.
 - Make all calls at home plate.
- U3:**
- Watch R1 and the BR touch second base.



Runner on First

U1 Chases - Ball is Caught

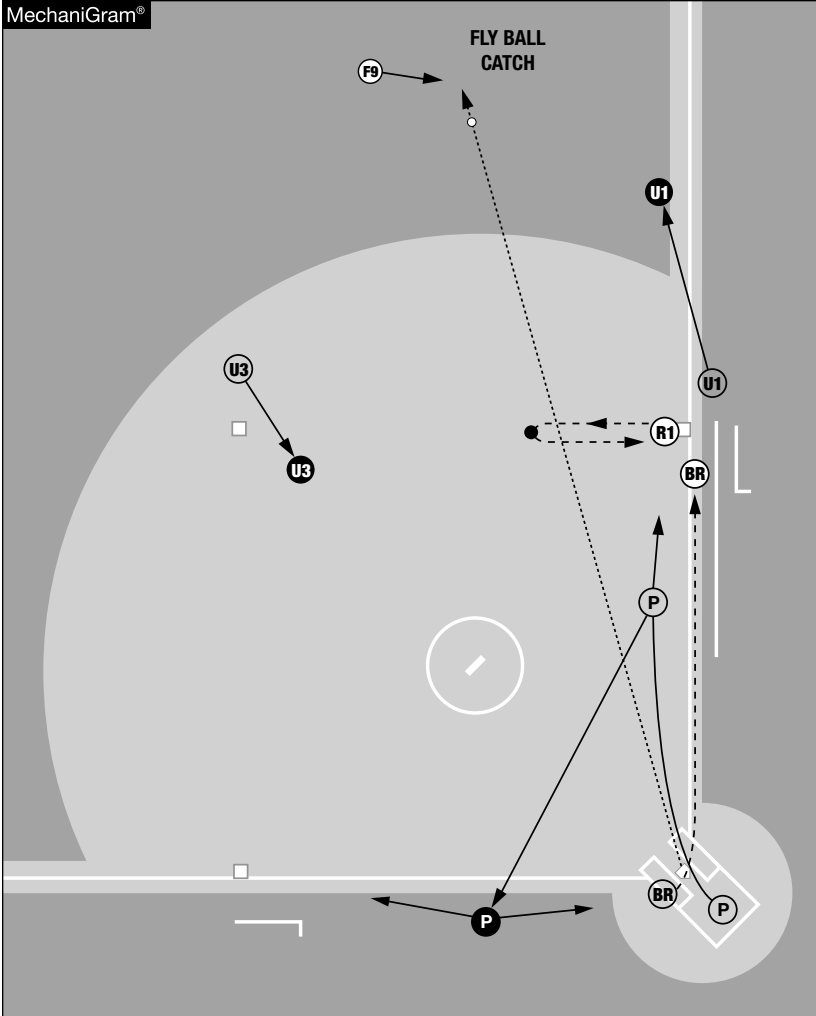

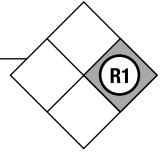

- P:**
- Move to align yourself with the ball and R1 to watch the tag up.
 - Make all initial calls at first base.
 - If R1 fully commits to second base, move to the holding area in foul territory between home and third base.
 - Make all calls on R1 at third base or home plate.
- U3:**
- Move inside the diamond or stay outside to make all calls at second base.



Runner on First

U1 Chases - Ball is Not Caught

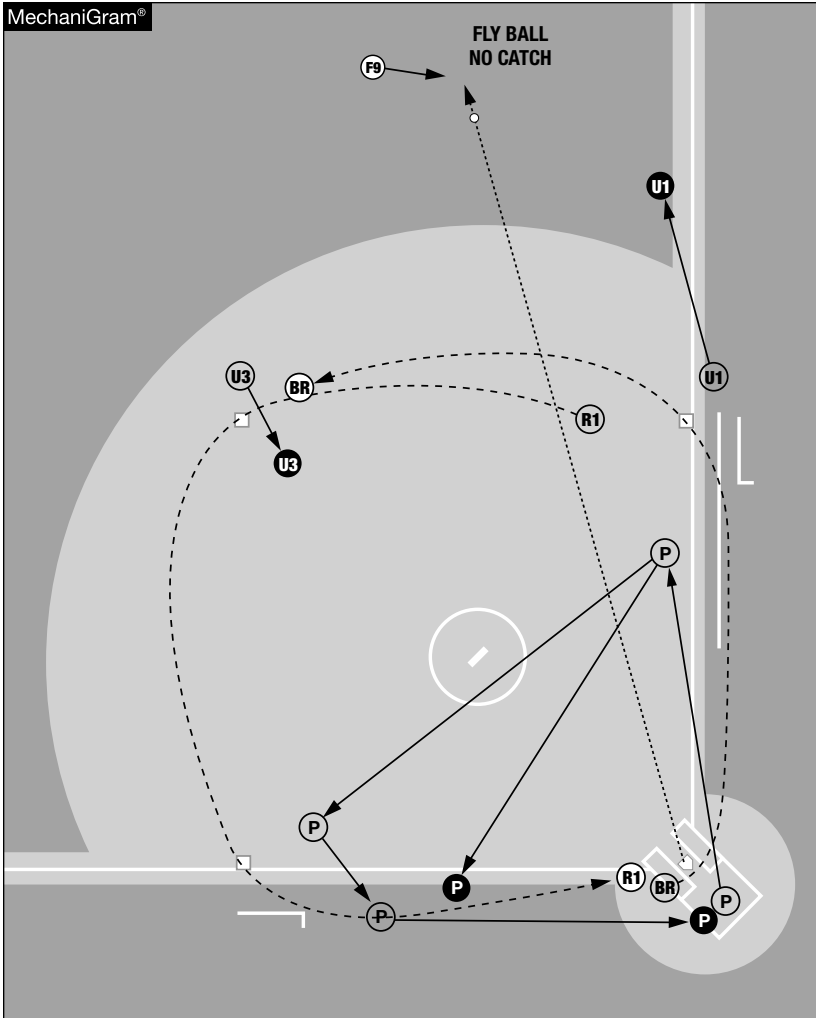

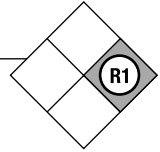

- P:**
- Obtain a credible position between the circle and first base to make all calls on the BR at first base.
 - If the play develops with no play at first base, move to a primary position for a tag play at third base and make all calls on R1.
 - If there will not be a play at third base on R1, move to the holding area between home plate and third base.
 - Make all calls at home plate.
- U3:**
- Make all calls at second base on R1.
 - Make all calls at second or third base on the BR.
 - Be prepared to make any subsequent calls on the BR at first base if the plate umpire moves to third base.



Runner on First

U1 Chases - Two Outs

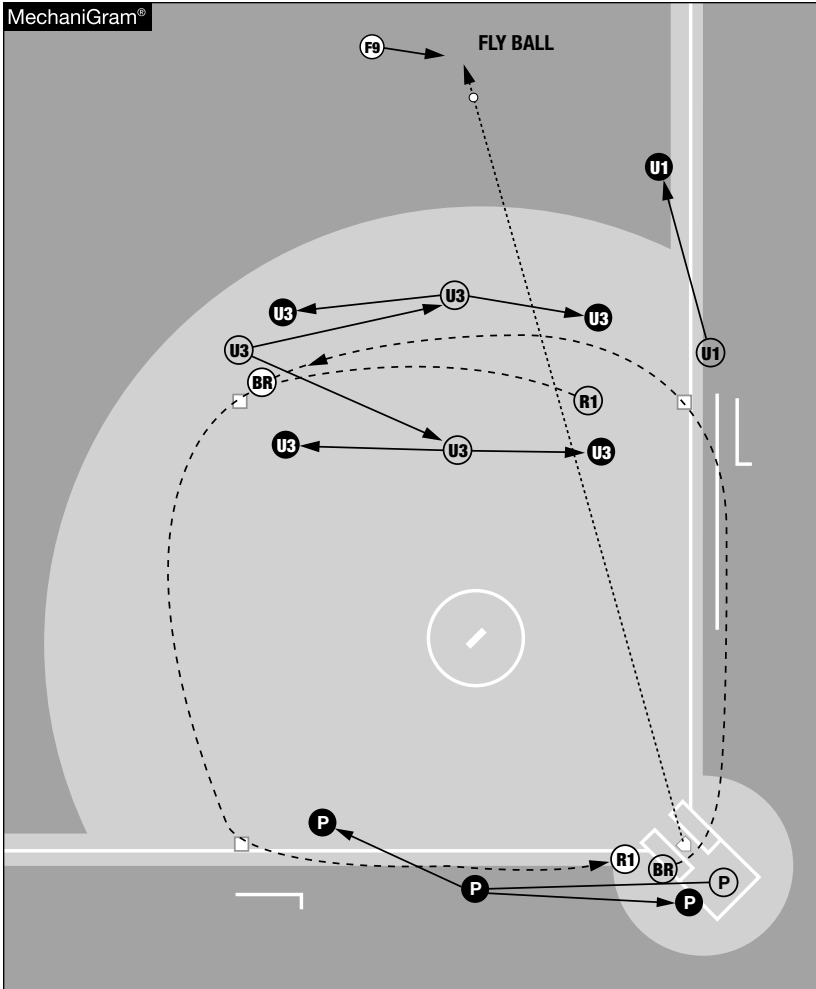

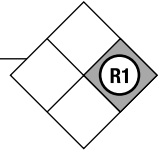

- P:**
- As R1 advances to second base, move to the holding area in foul territory between third base and home plate.
 - Make all calls on R1 at third base.
 - Make all calls at home plate.
- U3:**
- Make all calls at first and second base.
 - Make all calls on the BR at third base.



Runner on First

U1 Chases - Home Run (Out-of-the-Park)

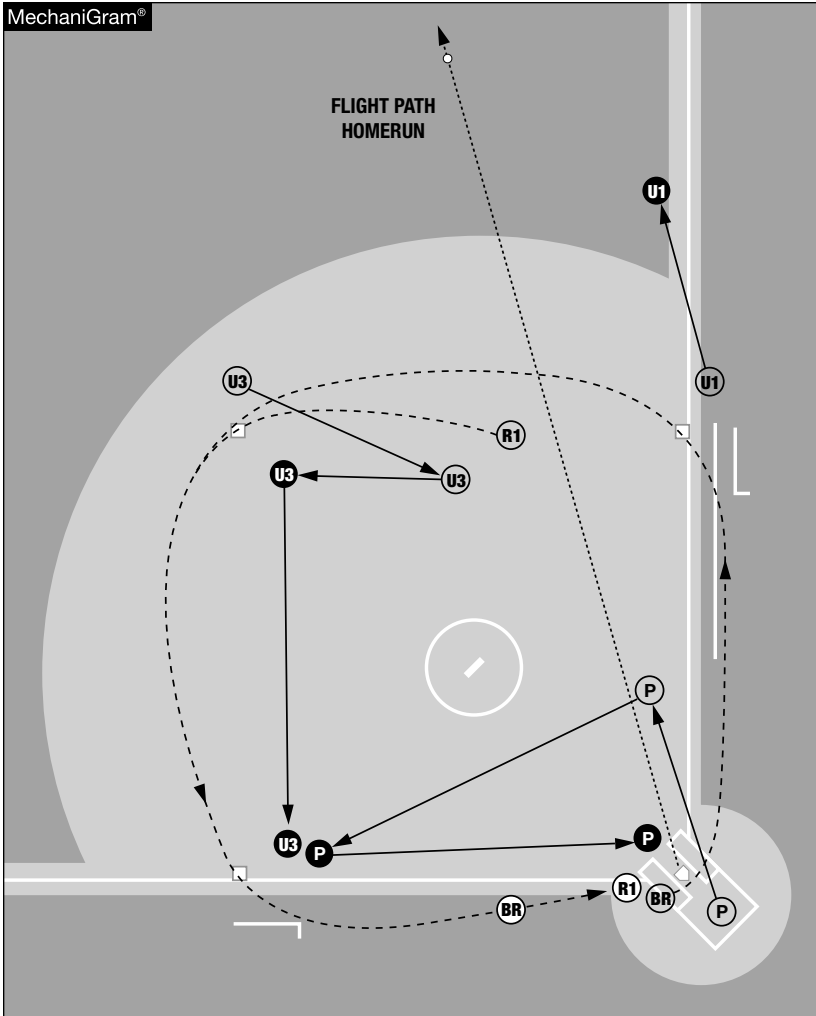

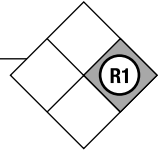

- P:**
- With less than 2 outs, move towards first base and watch the BR touch and round first base.
 - After watching the BR touch first, move to an infield position at third base.
 - With 2 outs, move into the infield in the direction of the flight of the ball. After the home run signal move to an infield position at third base.
 - Watch R1 touch third base and move to an infield position in front of home plate with R1.
 - Make all calls at home plate.
 - After the BR touches home plate, give a ball to the pitcher, catcher or closest infielder.
- U3:**
- Move inside the diamond to a position between first and second base.
 - Watch R1 touch second base.
 - Watch the BR touch first base if there are two outs.
 - Move along with the BR on the inside of the diamond.
 - Watch the BR touch second and third base.



Runner on First

U3 Chases - Ball is Caught

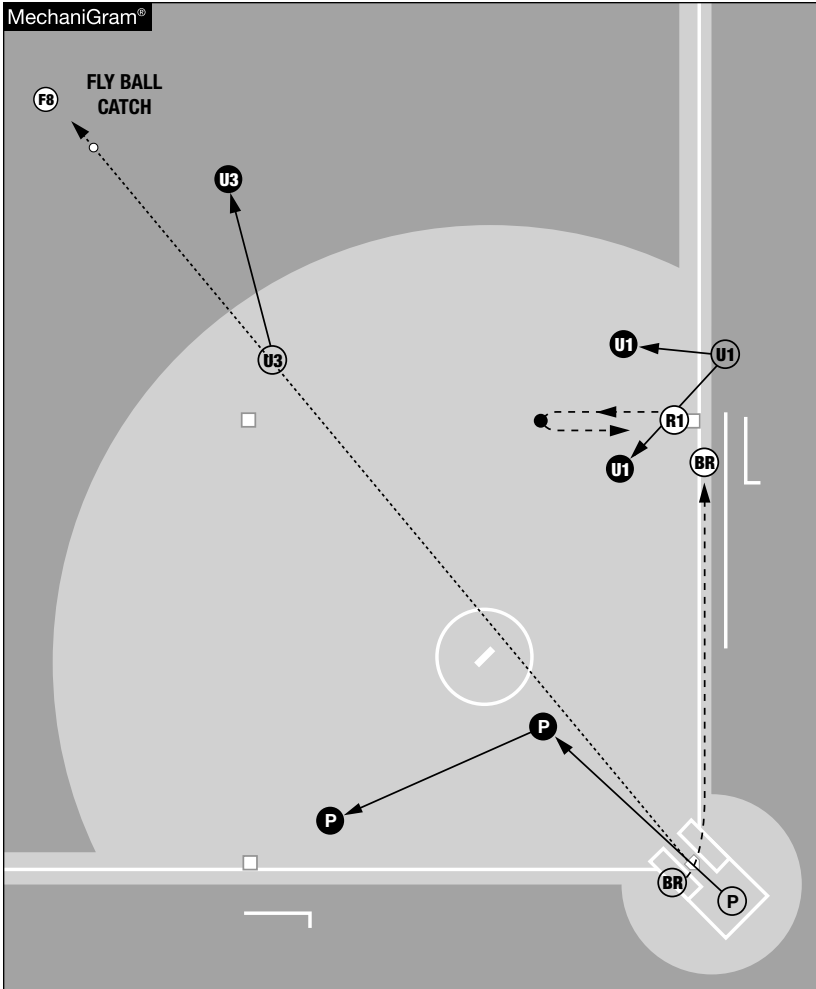

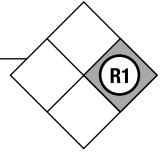

- P:**
- Move into the infield in the direction of the flight of the ball.
 - As R1 advances to second base, move to a primary position at third base.
 - Make all calls on R1 at third base and home plate.
- U1:**
- Stay outside the diamond or pivot inside (if necessary) in fair territory to align yourself with the ball and R1 to watch the tag up.
 - Make all calls on R1 at first base or second base.



Runner on First

U3 Chases - Ball is Not Caught

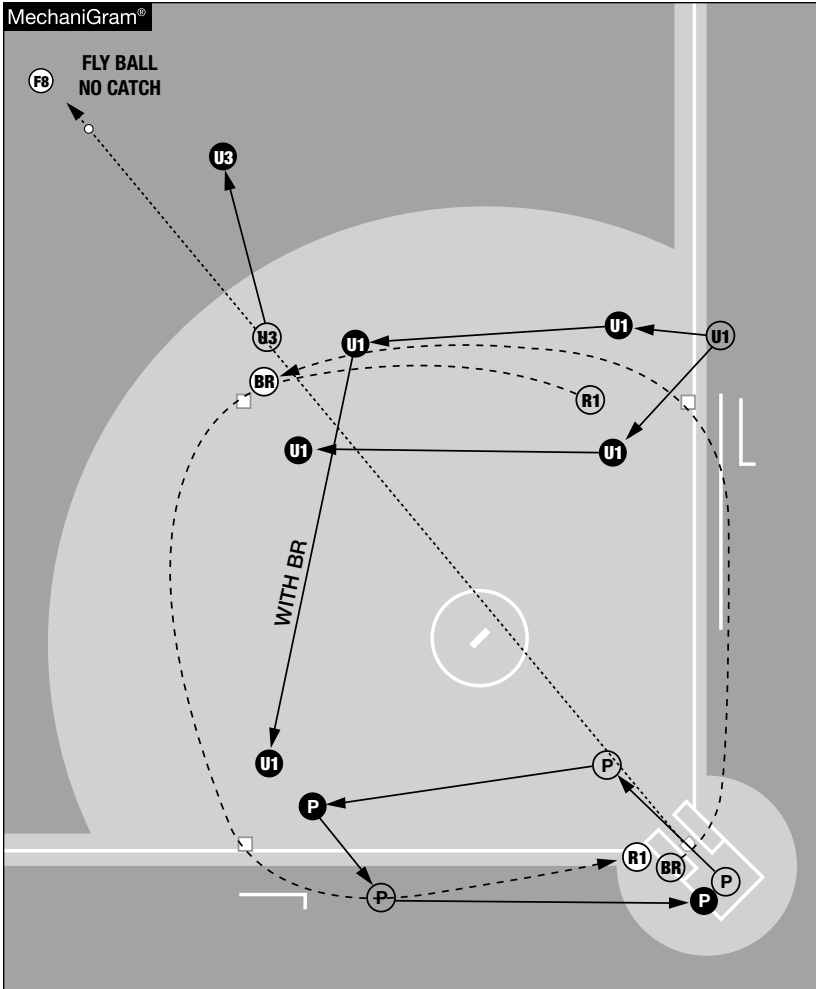

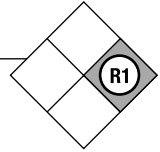

- P:**
- Move into the infield in the direction of the flight of the ball.
 - As R1 advances to second base, move to a primary position at third base.
 - Make all calls on R1 at third base.
 - Make all calls at home plate.
- U1:**
- Make all calls at first and second base.
 - As the BR approaches second base with the ball still in the outfield, move inside the diamond behind the BR.
 - Make all calls on the BR at third base.



Runner on First

U3 Chases - Home Run (Out-of-the-Park)

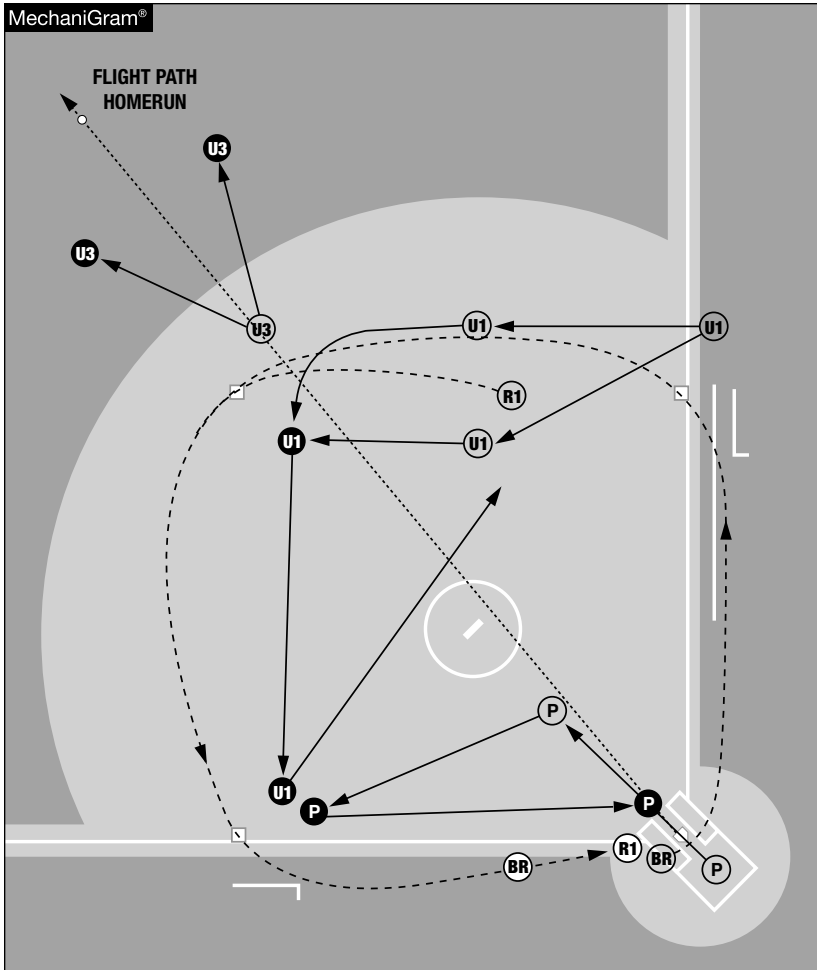

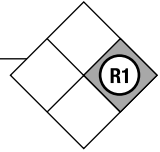

- P:**
- Move into the infield in the direction of the flight of the ball.
 - After the home run signal, move to an infield position at third base.
 - Watch R1 touch third base and move to an infield position in front of home plate with R1.
 - Make all calls at home plate.
 - After the BR touches home plate, give a ball to the pitcher, catcher or closest infielder.
- U1:**
- Stay outside the diamond or pivot inside (if necessary) to a position between first and second base.
 - Watch R1 touch second base.
 - Watch the BR touch first base.
 - As the BR approaches second base, move inside the diamond behind the BR and watch the BR touch second and third base.
 - While watching the BR continue to home plate, jog diagonally across the field heading to the next starting position.



Runner on Second “Counter-Rotated” Starting Position

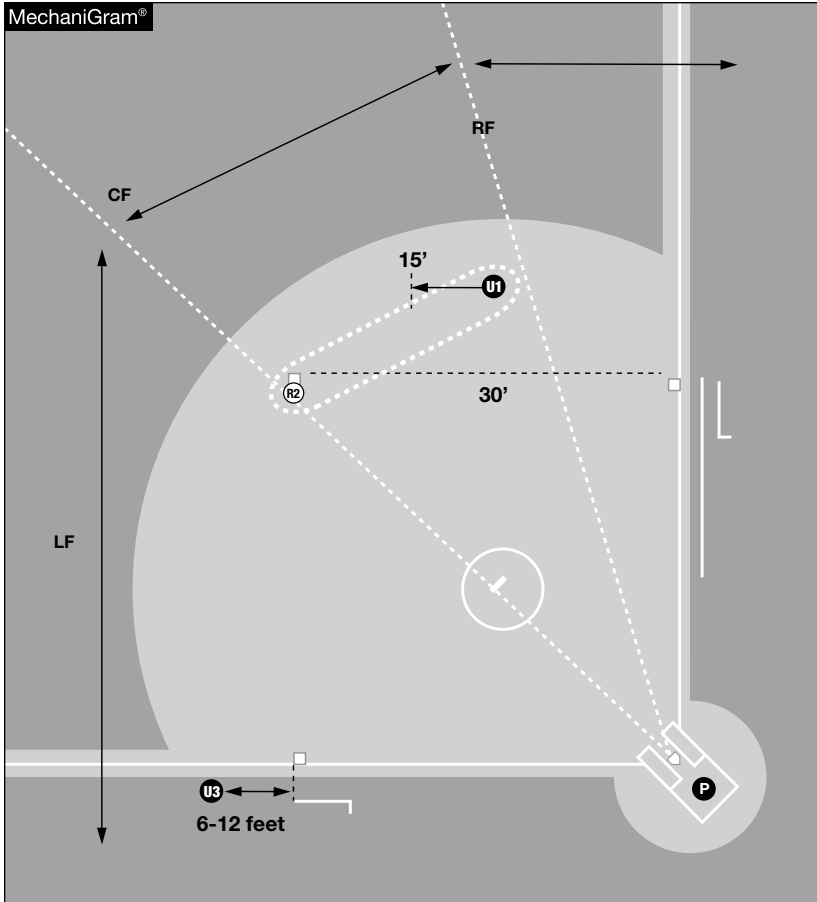

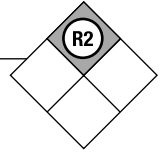

- P: Checked Swing – U3.**
Fly Ball Coverage Area – Right fielder to the right field dead ball line. When no umpire chases, all fly balls.
Tag Up Responsibilities – None.
- U1: Before the pitch -** Umpire option to come to set prior to the pitch, remain standing during the pitch, or take a step with the pitch, between 15 feet from second base and the 30-foot midpoint between first and second base.
On the pitch - Responsible for watching R2 for leaving the base before the pitch is released.
Checked Swing – None.
Fly Ball Coverage Area - The wedge from the center fielder to right fielder. U1 has the right of first refusal on balls hit to the center fielder.
Tag Up Responsibilities – R2 when no umpire chases or U3 chases a fly ball from the center fielder to the left field dead ball line.
- U3: Before the pitch -** Start in a set position, slightly angled towards the infield (opposite baseline between home and first base) completely in foul territory, within a foot of the line, 6-12 feet beyond third base.
On the pitch - No runner responsibilities.
Checked Swing – All batters.
Fly Ball Coverage Area – Center fielder to the left field dead ball line.
Tag Up Responsibilities – R2 when no umpire chases or U1 chases a fly ball from the center fielder to the right field dead ball line.



Runner on Second

R2 - Working Between Pitches (WBP) Pickoff - Steal

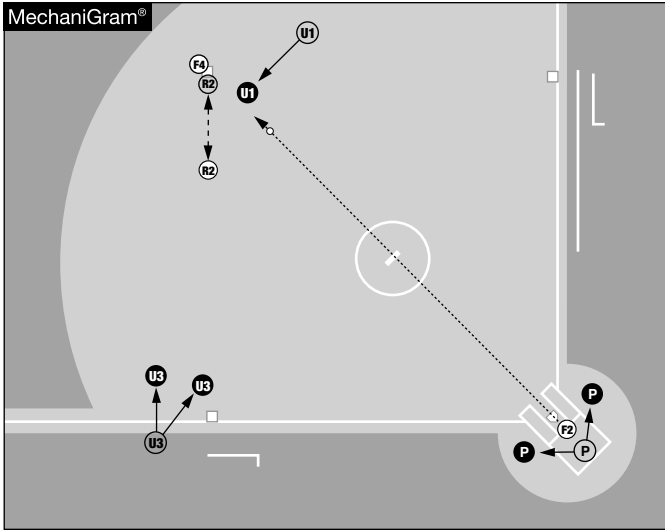

Pickoff at Second

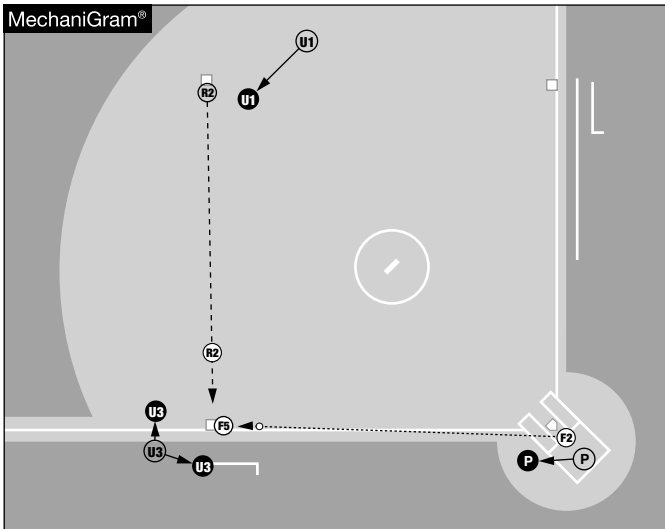

R2 Steal to Third

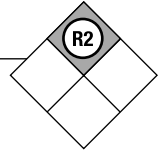

- P: WBP** – Complete the verbal and/or signal. Reset out of stance when the pitch is over completing verbal and/or signal. Remain alert to the batter's actions and the catcher for any play.
- Pickoff** – When the pitch is over, watch the catcher's attempt to throw the ball to second base. Look for batter interference. After the throw is released, step out from home plate, clearing the catcher and batter to watch the play at second base.
- Steal** – When the pitch is over, watch the catcher's attempt to throw the ball to third base. Look for batter interference. After the throw is released, step out from home plate, clearing the catcher and batter to watch the play at third base. If R2 steals as a result of a passed ball, remain in the plate area, avoiding any throwing lanes to third base. Keep tracking the ball and make any call on the ball that might be blocked or enters dead ball area.
- U1: WBP** – Come out of the set position, move toward second base and watch for a possible play or obstruction. When the ball is in the circle with the pitcher and R2 has returned to second base, return to starting position.
- Pickoff** – Come out of the set position, move to a primary position, read the play as it develops and adjust positioning as necessary to watch the applied tag or any play at second base.
- Steal** – Come out of the set position and move to the baseline. Stop and watch any play at third base.
- U3: WBP** – Stay in a set position and watch for a possible play or obstruction at second base. When the ball is in the pitcher's circle with the pitcher and R2 has returned to first base, reset to a standing position.
- Pickoff** – Come out of the set position and move as needed to watch any play at second base.
- Steal** – Come out of the set position, read the play as it develops and adjust positioning as necessary to see the applied tag or any play at third base.



Runner on Second

Hit to the Infield

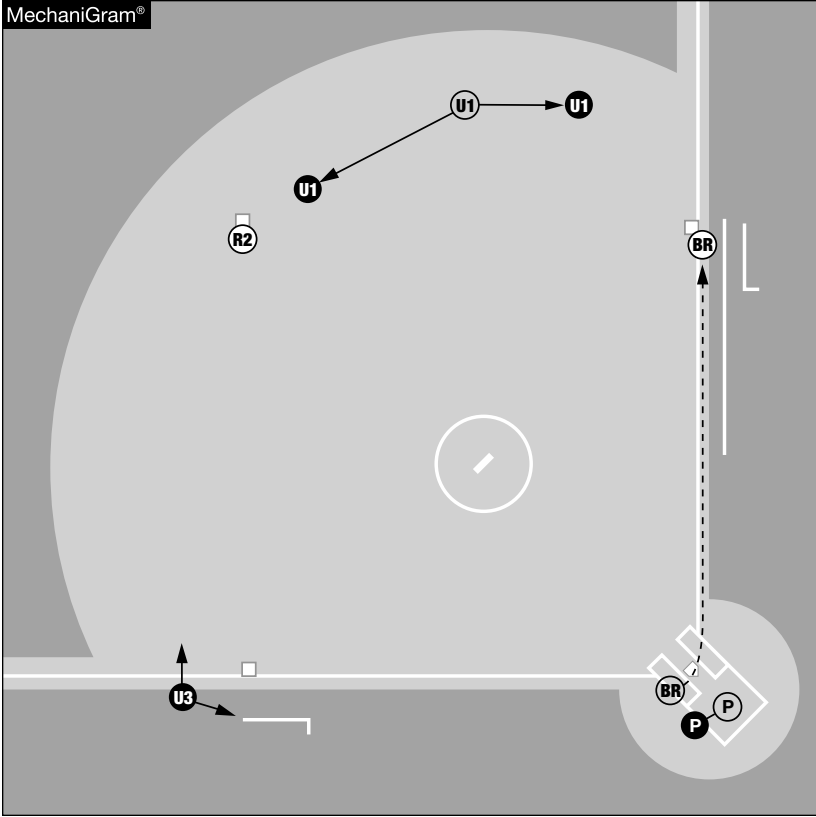

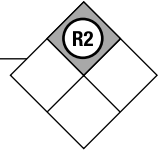

- P:**
- On a throw to first base, move to a first base line extended trail position in foul territory.
 - When there is no throw to first base, move to the point of plate holding position.
 - Make all calls at home plate
- U1:**
- Make all calls on the BR at first base and R2 at second base.
 - When the initial throw is at first base, commit to a primary position for a force play at first base.
 - When the initial play is on R2, commit to a primary position for tag on R2 at second base.
- U3:**
- Make all calls at third base.



Runner on Second

Foul Fly Ball to the Infield Area

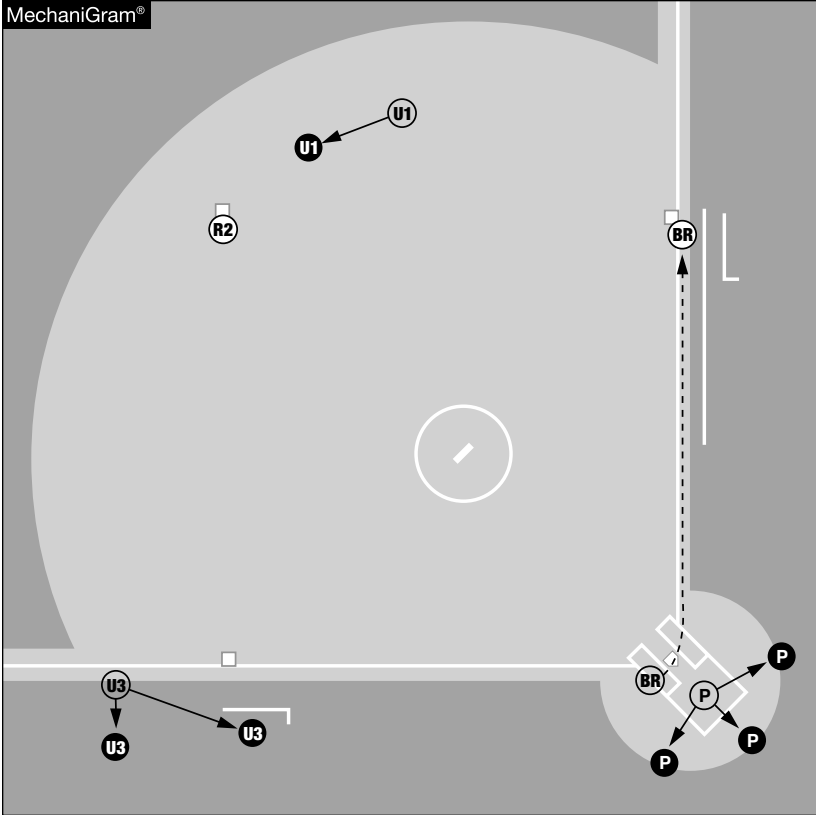

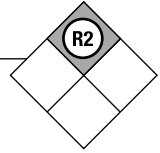

- P:**
- Once the ball is hit, read the catcher. Do not locate the ball first. Allow the catcher to take you to the ball.
 - Open pivot to the catcher's back creating room for the catcher to go to the ball.
 - Close-down the distance to the play if the infielders are diving, the ball is against the fence or near the dugout area.
 - If U3 is bracketing on the third base side, make the call on the catch/no catch if the play is facing you, the field or the dugout. Otherwise, U3 will make the call, if the play is facing them.
 - The responsibility for the catch/no catch belongs to the plate umpire, if the catch is not facing either umpire.
- U1:**
- Move to align yourself with the ball and R2 to watch the tag up.
 - Make all calls at second base.
- U3:**
- Move into foul territory to bracket the play with the plate umpire.
 - Close-down the distance to the play if the infielders are diving, the ball is against the fence or near the dugout area.
 - Make the call on the catch/no catch if the play is facing you. Otherwise, the plate umpire will make the call.
 - After the catch is made, quickly move back to third base and make any call on R2 at third base.



Runner on Second

No Chase - Fly Ball/Line Drive - Ball is Caught

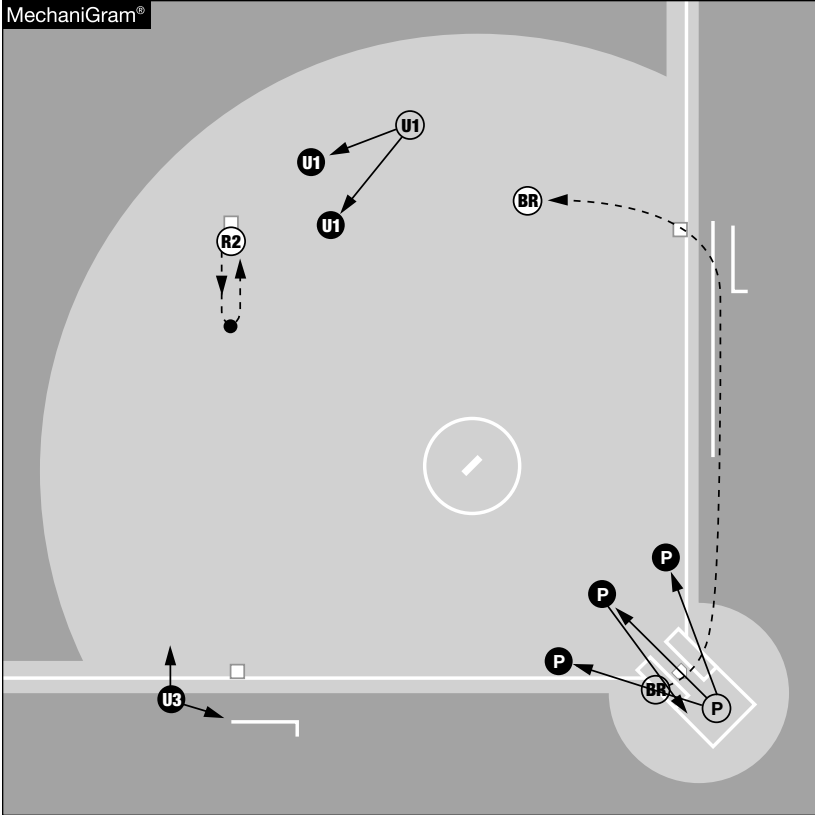

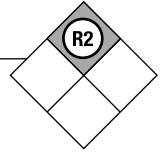

- P:**
- Move into the infield in the direction of the flight of the ball.
 - After the catch, move to the point of plate holding position.
 - Make all calls at home plate.
- U1:**
- Move to align yourself with the ball and R2 to watch the tag up on a ball hit between the center fielder and the left field dead ball line.
 - Make all calls at second base.
- U3:**
- Move in foul territory to align yourself with the ball and R2 to watch the tag up on a ball hit between the center fielder and the right field dead ball line.
 - Make all calls at third base.



Runner on Second

No Chase - Ball is Not Caught

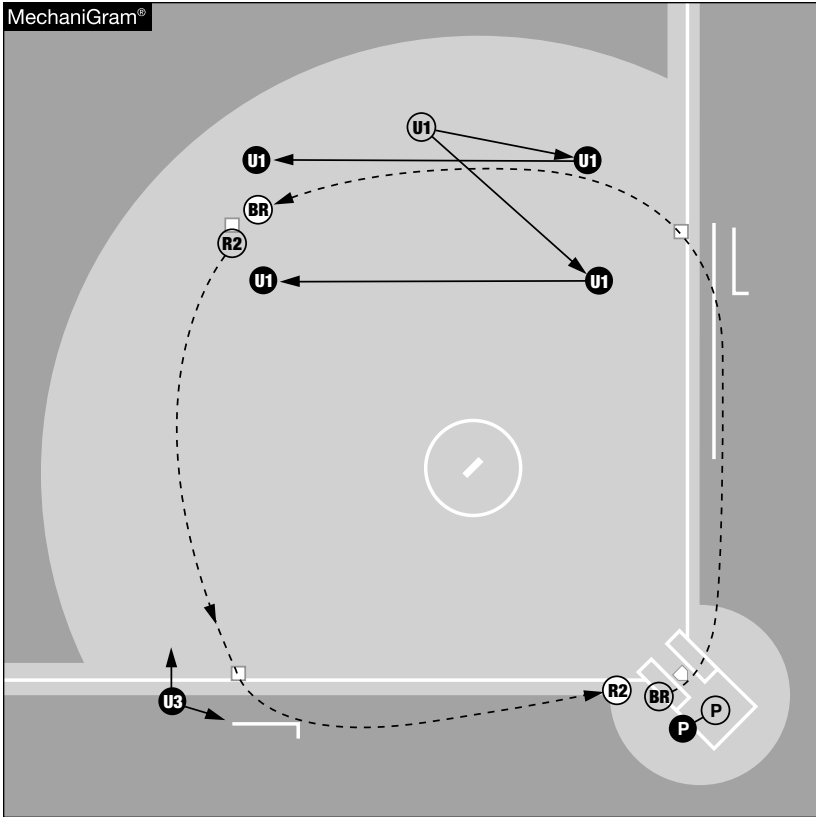

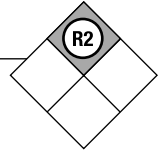

- P:**
- On a throw to first base from right field, move to a first base line extended trail position in foul territory.
 - When the throw from the outfield is not to first base, move to point of the plate holding position.
 - Make all calls at home plate.
- U1:**
- Make all calls at first or second base.
- U3:**
- Make all calls at third base.
 - When R2 advances to home plate and the ball is still in the outfield, look at U1 with the BR. If they are heading to second base, hold your position. If the BR reverses direction back to first base, run hard to a primary position at second base and communicate to U1.



Runner on Second

No Chase - Home Run (Out-of-the-Park)

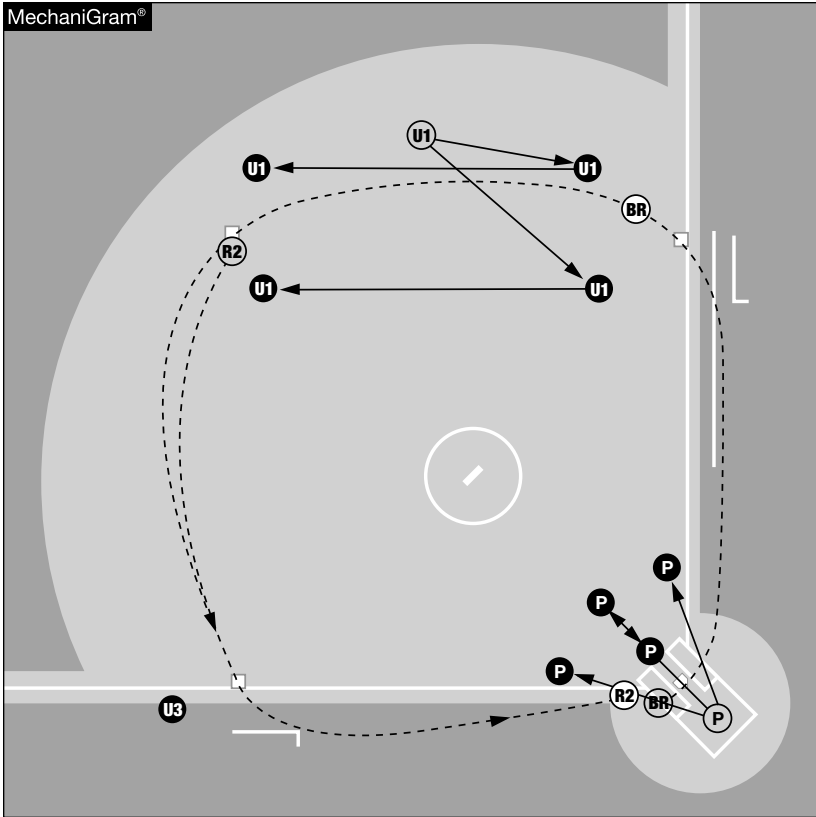

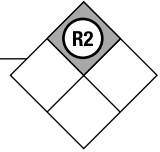

- P:**
- Move into the infield in the direction of the flight of the ball.
 - After signaling home run, move to an infield position in front of home plate.
 - Make all calls at home plate.
 - After the BR touches home plate, give a ball to the pitcher, catcher or closest infielder.
- U1:**
- Watch the BR touch first and second base.
 - As the BR continues to third base and then home plate, move briskly toward your next starting position.
- U3:**
- Watch R2 and the BR touch third base.



Runner on Second

U1 Chases - Ball is Caught

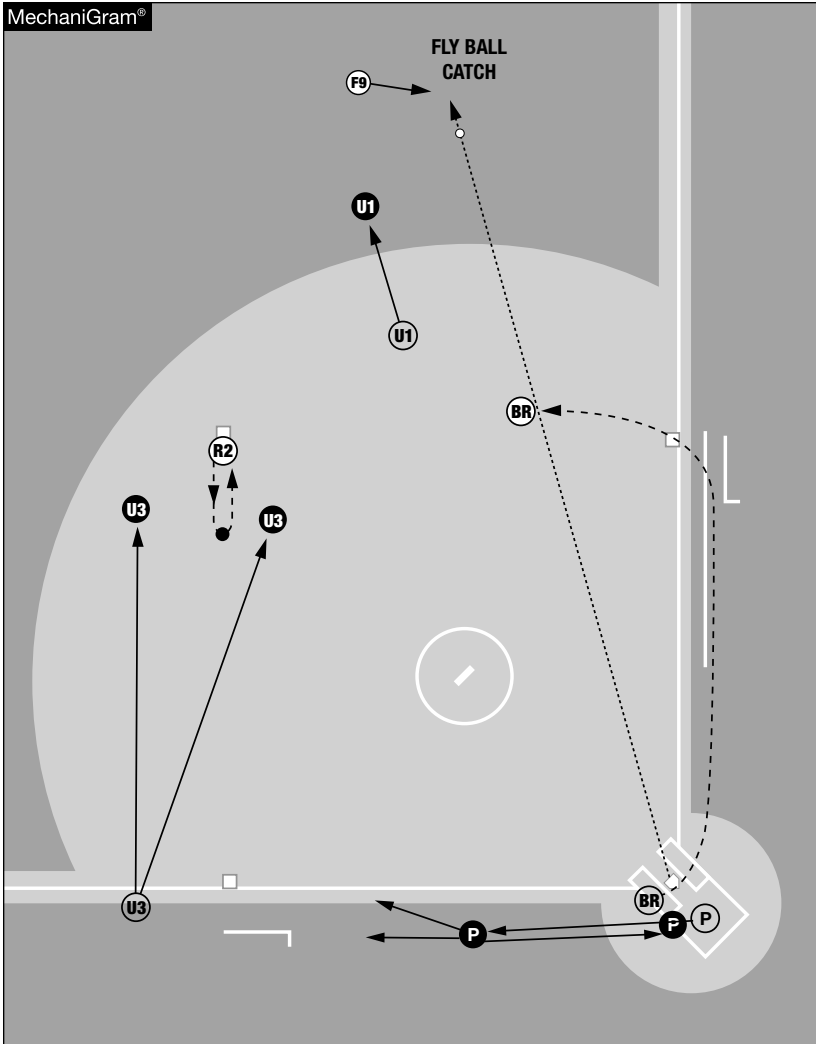

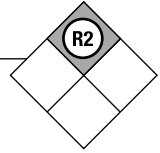

- P:**
- Move to the holding area in foul territory between home plate and third base.
 - Make all calls on R2 at third base and home plate.
- U3:**
- Move to align yourself with the ball and R2 to watch the tag up.
 - Make all calls at second base.

Runner on Second

U1 Chases - Ball is Not Caught

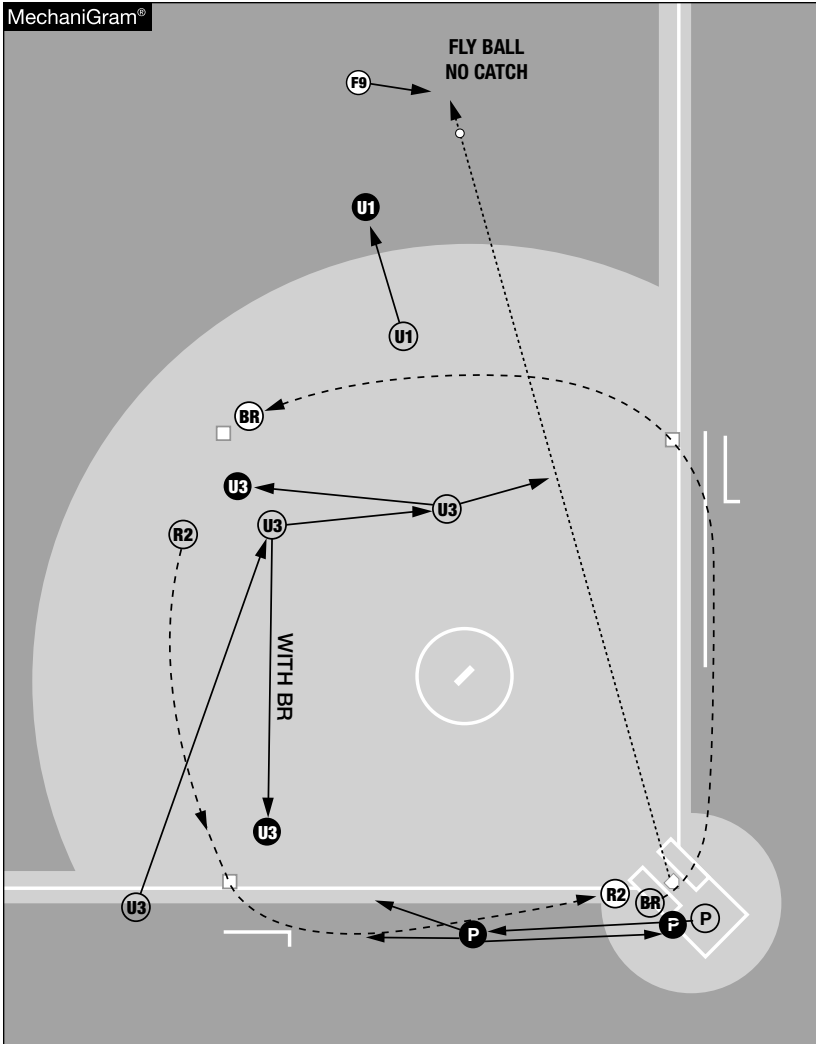

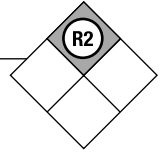

- P:**
- Move to the holding area in foul territory between home plate and third base.
 - Make all calls on R2 at third base.
 - Make all calls at home plate.
- U3:**
- Move across the infield.
 - Make all calls on the BR at first, second and third base.

Runner on Second

U1 Chases - Home Run (Out-of-the-Park)

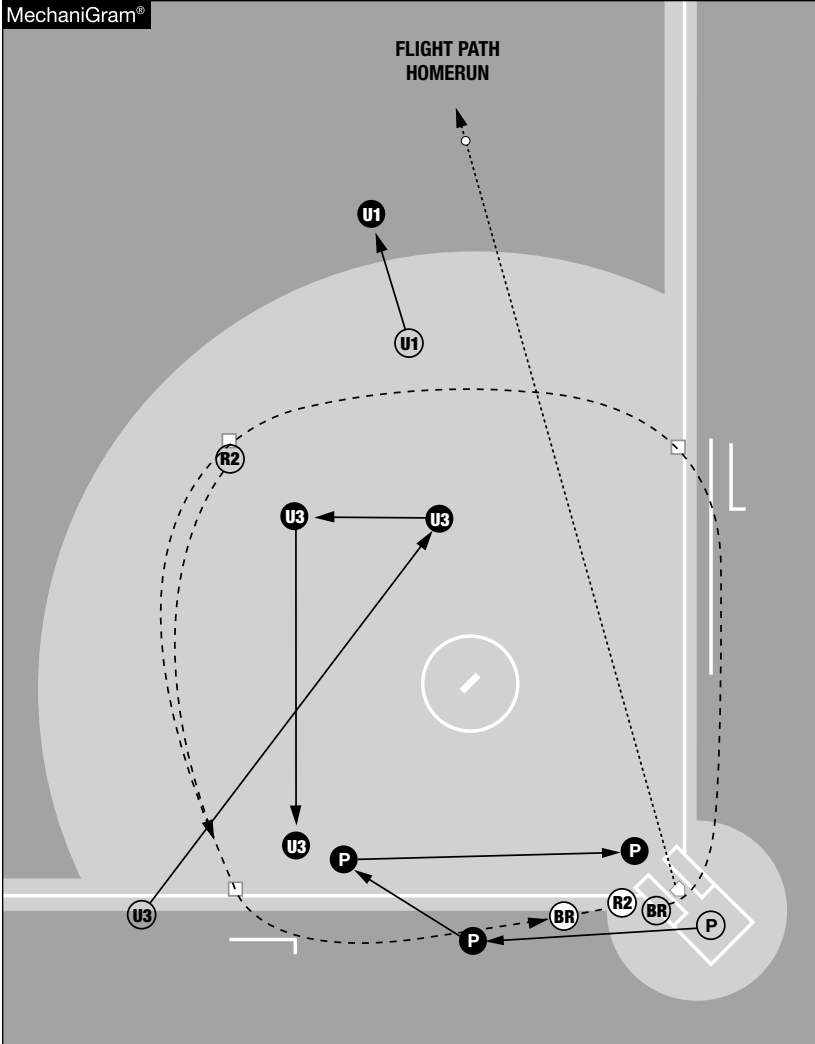

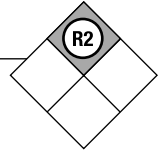

- P:**
- Move to the holding area in foul territory between home and third base.
 - After the home run signal, move to an infield position at third base.
 - Watch R2 touch third base and move to an infield position in front of home plate with R2.
 - Make all calls at home plate.
 - After the BR touches home plate, give a ball to the pitcher, catcher or closest infielder.
- U3:**
- Move across the infield.
 - Watch the BR touch all bases, move along with the BR on the inside of the diamond.



Runner on Second

U3 Chases - Ball is Caught

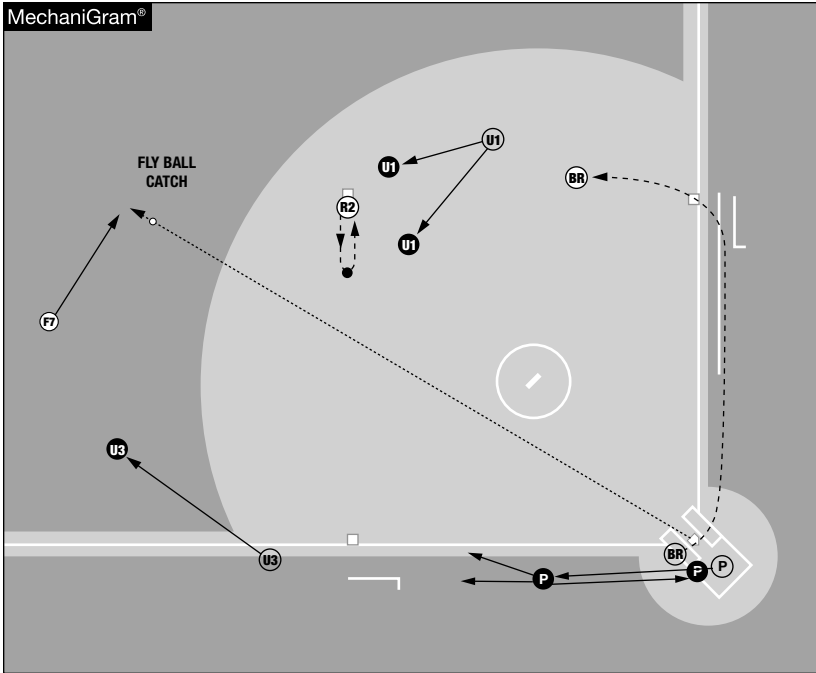

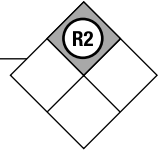

- P:**
- Move to the holding area in foul territory between home plate and third base.
 - Make all calls on R2 at third base and home plate.
- U1:**
- Move to align yourself with the ball and R2 to see the tag up.
 - Make all calls at second base.

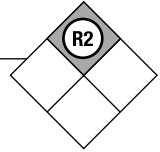

- P:**
- Move to the holding area in foul territory between home plate and third base.
 - Make all calls on R2 at third base.
 - Make all calls at home plate.
- U1:**
- Make all calls at first and second base.
 - As the BR approaches second base with the ball still in the outfield, move inside the diamond behind the BR.
 - Make all calls on the BR at third base.



Runner on Second

U3 Chases - Home Run (Out-of-the-Park)

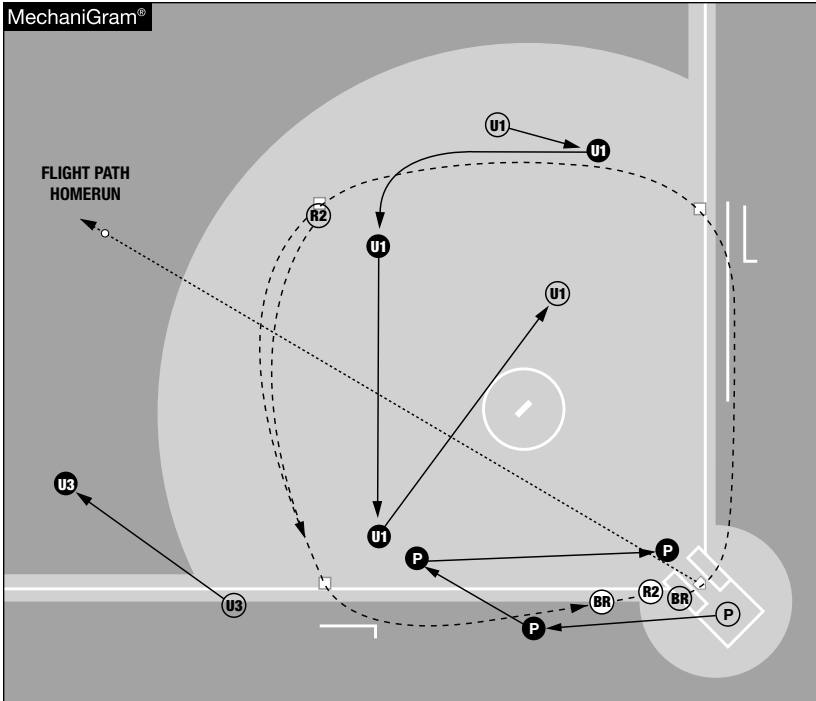

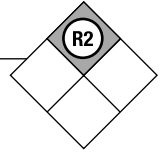

- P:**
- Move to the holding area in foul territory between home plate and third base.
 - After the home run signal, move to an infield position at third base.
 - Watch R2 touch third base and move to an infield position in front of home plate with R2.
 - Make all calls at home plate.
 - After the BR touches home plate, give a ball to the pitcher, catcher or closest infielder.
- U1:**
- Watch the BR touch first base.
 - As the BR is approaching second base, move inside the diamond behind the runner.
 - Watch the BR touch second and third base.
 - While watching the BR continue to home plate, jog diagonally across the field heading to the next starting position.



Runner on Third "Standard" Starting Position

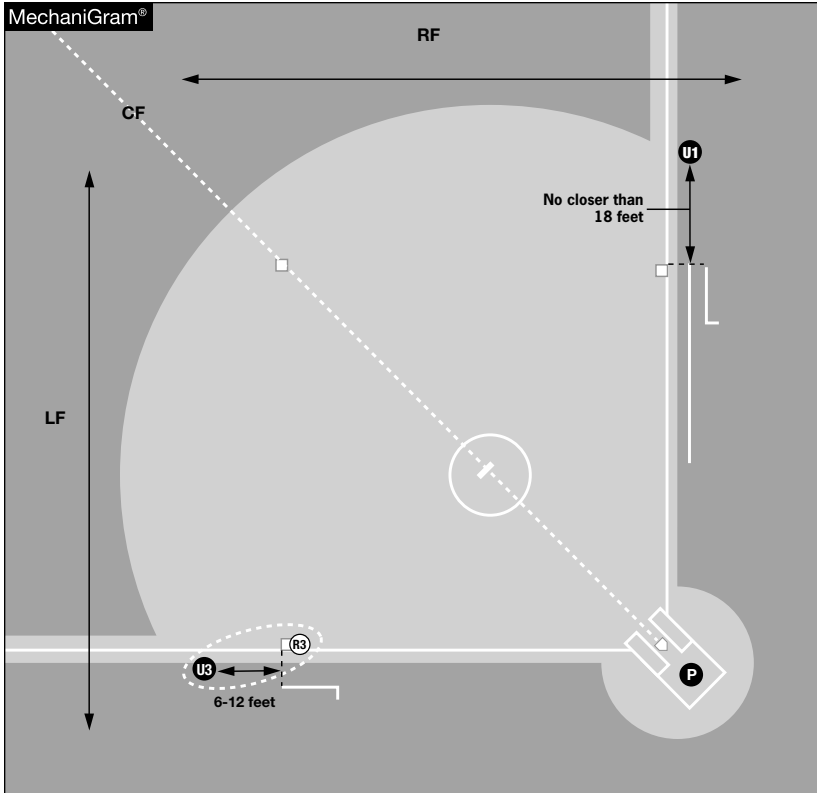

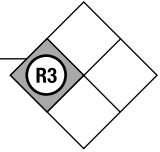

- P: Checked Swing** – Request help from the open umpire on the line.
Fly Ball Coverage Area – When no umpire chases, all fly balls.
Tag Up Responsibilities – R3 when U1 or U3 chases.
- U1: Before the pitch** – Start no closer than 18 feet beyond first base and within a foot of the line, completely in foul territory in an upright standing or set position.
On the pitch – No runner responsibilities. If standing upright, move forward a maximum of two steps, facing home plate, ending in a prepared-set or stopped in a standing prepared position with the outside push foot forward as the pitch reaches the front of the plate area.
Checked Swing – Right-handed batters.
Fly Ball Coverage Area – Center fielder to the right field dead ball line. U1 has the right of first refusal on balls hit to the center fielder.
Tag Up Responsibilities – None.
- U3: Before the pitch** – Start in a set position, slightly angled towards the infield (opposite baseline between home and first base) completely in foul territory, within four feet of the line, with a clear view of the check swing, 6-12 feet beyond third base.
On the pitch – Responsible for watching R3 for leaving the base before the pitch is released.
Checked Swing – Left-handed batters.
Fly Ball Coverage Area – Center fielder to the left field dead ball line.
Tag Up Responsibilities – R3 when no umpire chases.



Runner on Third

R3 – Working Between Pitches (WBP) Pickoff – Steal

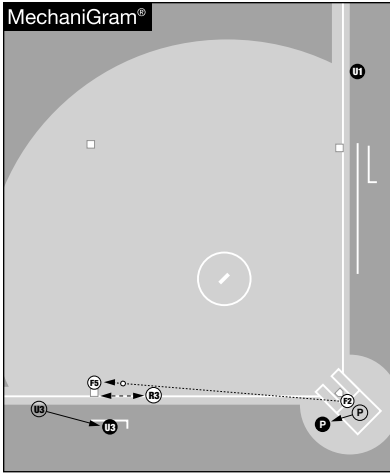

**Pickoff at Third
"At the Base"**

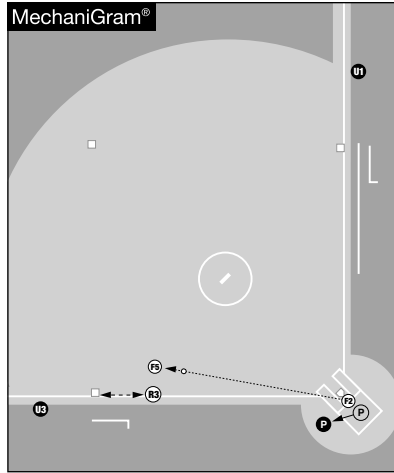

**Pickoff at Third
"Away from the Base"**

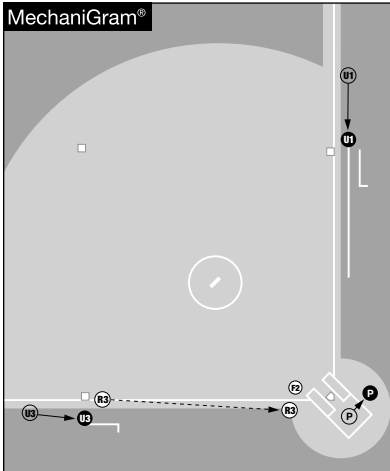

**Steal from Third
"Tag Away from the Plate"**

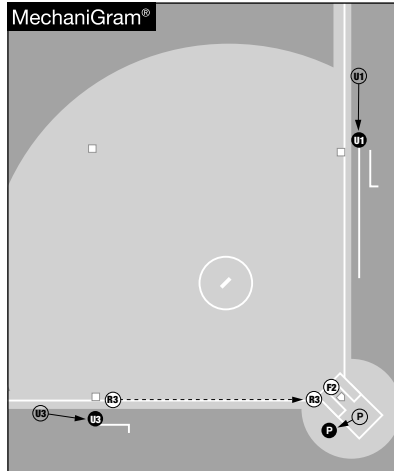

**Steal From Third
"Tag at the plate"**

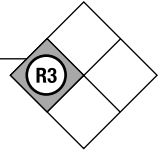

- P:** **WBP** – Complete the verbal and/or signal. Reset out of stance when the pitch is over completing verbal and/or signal. Remain alert to the batter's actions and the catcher for any play.
- Pickoff** – When the pitch is over, watch the catcher's attempt to throw the ball to third base. Look for batter interference. After the throw is released, step out from home plate, clearing the catcher and batter to watch the play at third base.
- Steal** – When the pitch is over, read the play as it develops and adjust positioning as necessary to see the applied tag or any play at home plate. Watch R3 approach and touch home plate. When R3 steals as a result from a passed ball, remain in the plate area, avoiding any throwing lanes. Keep tracking the ball and make the call (blocked ball, interference, enters dead ball area, etc.) if necessary.
- U1:** **WBP** – Remain in a standing or set position facing home plate. When the ball is in the pitcher's circle with the pitcher and R3 has returned to third base, return to starting position.
- Pickoff** – Remain in a standing position.
- Steal** – Remain in a standing or set position facing home plate.
- U3:** **WBP** – Stay in a set position and watch for a possible play or obstruction. When the ball is in the pitcher's circle with the pitcher and R3 has returned to third base, reset to a standing position.
- Pickoff** – Move out of the set position, read the play as it develops and adjust positioning as necessary to see the applied tag or any play at third base.
- Steal** – Move out of the set position and move to the baseline in foul territory.



Runner on Third

Hit to the Infield

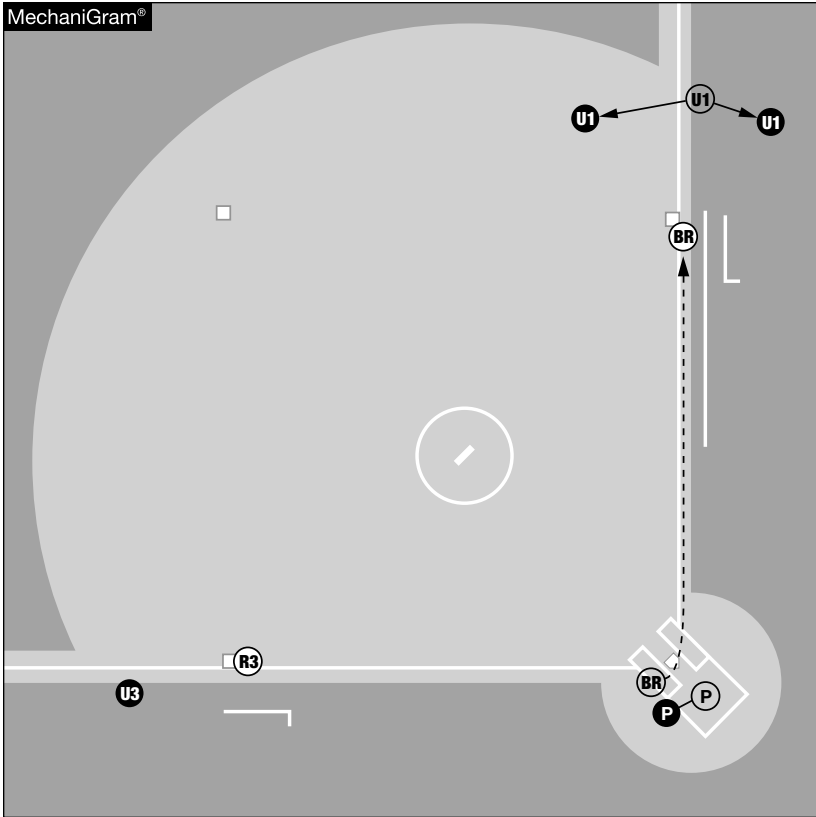

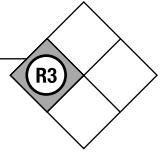

- P:**
- On a throw to first base, move to a first base line extended trail position in foul territory.
 - When there is no throw to first base, move to the point of plate holding position.
 - Make all calls at home plate.
- U1:**
- Move into fair or foul territory to make all calls at first base.
 - Be prepared to take the BR to second base.
- U3:**
- Make all calls on R3 at third base.



Runner on Third

Foul Fly Ball to the Infield Area

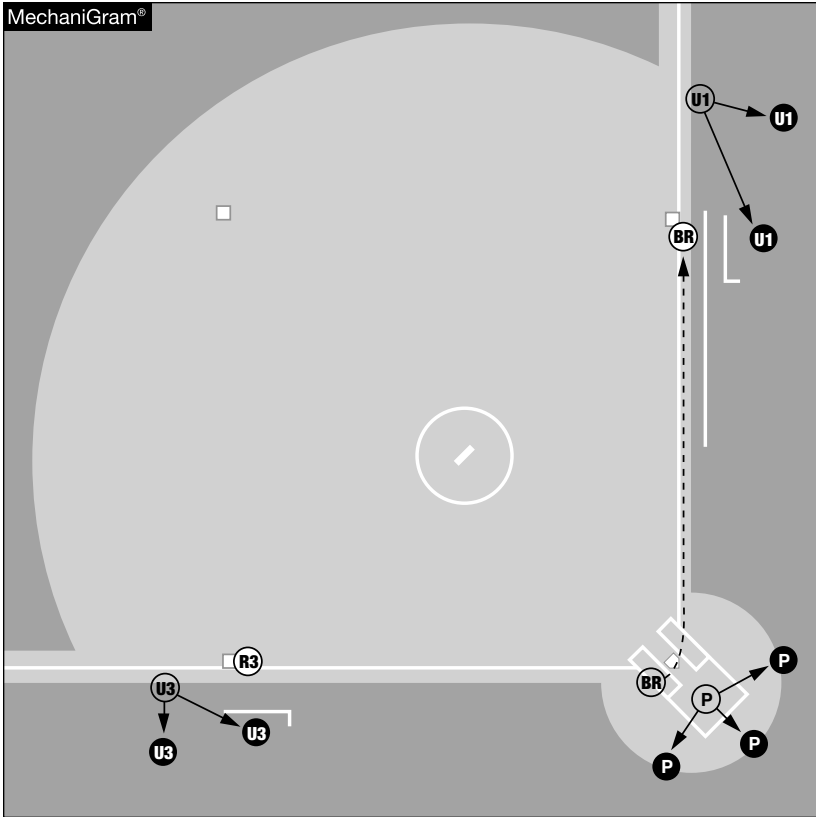

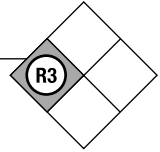

- P:**
- Once the ball is hit, read the catcher. Don't look for the ball first. Allow the catcher to take you to the ball.
 - Open pivot to the catcher's back creating room for the catcher to go to the ball.
 - Close-down the distance to the play if the infielders are diving, the ball is against the fence or near the dugout area.
 - When a base umpire is bracketing the play, make the call on catch/no catch if the play is facing you, the field or the dugout. Otherwise, the base umpire who the play is facing will make the call.
 - The responsibility for the catch/no catch belongs to the plate umpire, if the catch is not facing either umpire.
 - If U3 makes the catch call, be prepared to make the tag-up call or any tag play at third base. After the catch is made, quickly move back to the point of plate holding position and make any call on R3.
- U1:**
- When a fly ball is on the first base side, move into foul territory to bracket the play with the plate umpire.
 - Close-down the distance to the play if the infielders are diving, the ball is against the fence or near the dugout area.
 - Make the call, catch/no catch when the play is facing you. Otherwise, the plate umpire will make the call.
 - When the fly ball is on the third base side, move into fair territory.
- U3:**
- Remain close to third base to watch R3 tag up.
 - Watch R3 return and make any call at third base.
 - If bracketing with the plate umpire and the plate umpire has the call, focus on tag up responsibilities on R3. If you have the call, the plate umpire will handle tag up responsibilities on R3.



Runner on Third

No Chase - Fly Ball/ Line Drive - Ball is Caught

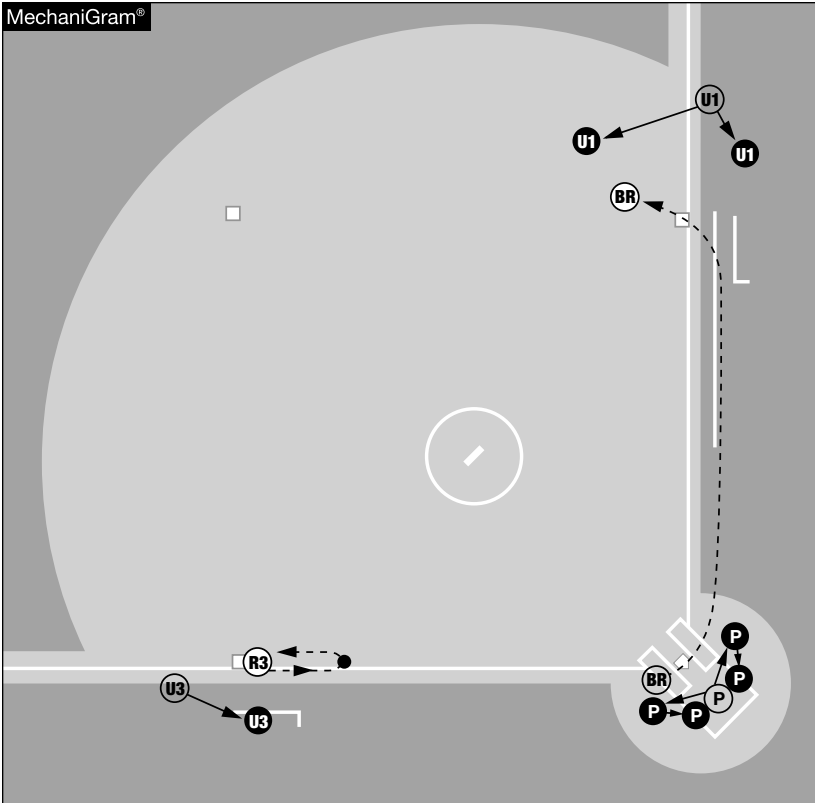

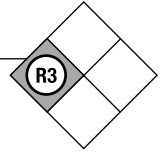

- P:**
- Stay in foul territory or straddle the base line at home plate.
 - After the catch, move to the point of plate holding position.
 - Make all calls at home plate.
- U1:**
- Make all calls at first base.
- U3:**
- Move to align yourself with the ball and R3 to watch the tag up.
 - Make all calls at third base.

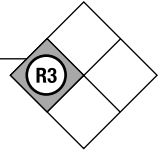

- P:**
- On a throw to first base from right field, move to a first base line extended trail position in foul territory.
 - When there is no throw to first base, move to the point of plate holding position.
 - Make all calls at R3 home plate.
 - After all plays at home plate on R3, move into the infield toward the holding area in front of the circle.
 - If the BR approaches second base, move to a primary position at third base.
 - Make all calls on the BR at third base.
- U1:**
- Move into fair or foul territory to make all calls at first base.
 - If the BR advances to second base, move up into the baseline in either fair or foul territory.
 - If the BR advances to third, mirror the advancement by moving all the way to the point of the plate holding area.
 - Make all calls at home plate.
 - Be prepared if R3 doesn't immediately score to take the BR to second base.
- U3:**
- When R3 advances immediately and will score without a play, move straight into the diamond to a primary position for a tag play at second base.
 - Make all calls at second base.
 - When R3 does not advance immediately, stay outside the diamond in foul territory at third base. Once R3 advances to home plate; look at U1 with the BR. If they are heading to second base, hold your position. If the BR reverses direction back to first base, run hard to a primary position at second base and communicate to U1.

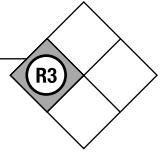

- P:**
- Stay in foul territory or straddle the base line at home plate.
 - After signaling home run, watch R3 touch home plate.
 - Move to a primary position near third base and watch the BR touch third base.
 - After the BR touches home plate, give a ball to the pitcher, catcher or closest infielder.
- U1:**
- Watch the BR touch first base.
 - Move to an infield position in front of home plate.
 - Make all calls at home plate.
 - If U3 stays at third for a potential tag up, watch the BR touch first and second base.
- U3:**
- Move straight into the diamond to a primary position for a tag play at second base.
 - Watch the BR touch second base.
 - If there is no chase and the potential of a tag up, stay at third base to line up the tag.



Runner on Third

U1 Chases – Ball is Caught

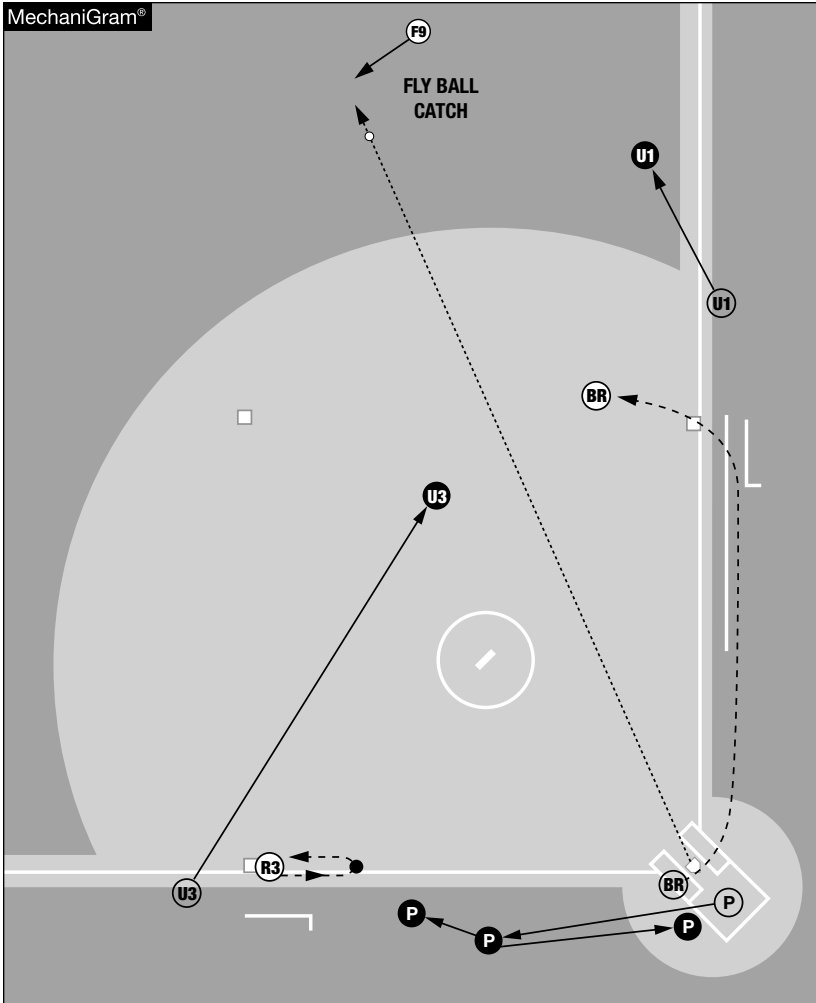

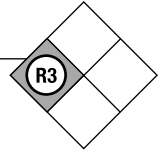

- P:**
- Move towards the holding area between home plate and third base to align yourself with the ball and R3 to see the tag up.
 - Make all calls on R3 at third base and home plate.
- U3:**
- Move across the infield toward first base.
 - Make all calls at first base.

Runner on Third

U1 Chases - Ball is Not Caught

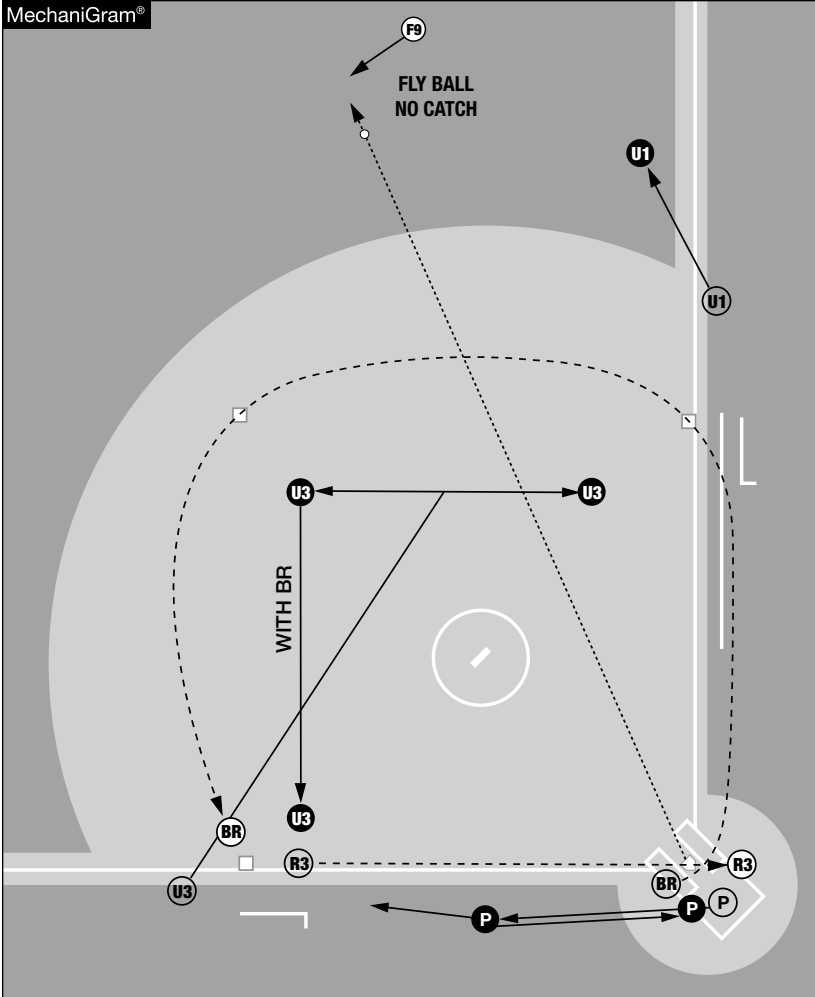

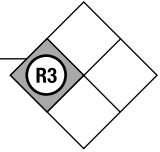

- P:**
- Move towards the holding area in foul territory between third base and home plate.
 - When there will be a play on R3 at home plate move to a position to make all calls at home plate.
 - When R3 scores without a play, watch the touch then read the BR.
 - If the BR slows down and/or stops at second base, move to third base and take any subsequent play at third base or home plate.
 - If there is no breakdown and the BR advances to third base move to the point of the plate.
 - Make all calls at home plate.
- U3:**
- Move across the infield.
 - Make all calls on the BR at first, second and third base.



Runner on Third

U1 Chases - Home Run (Out-of-the-Park)

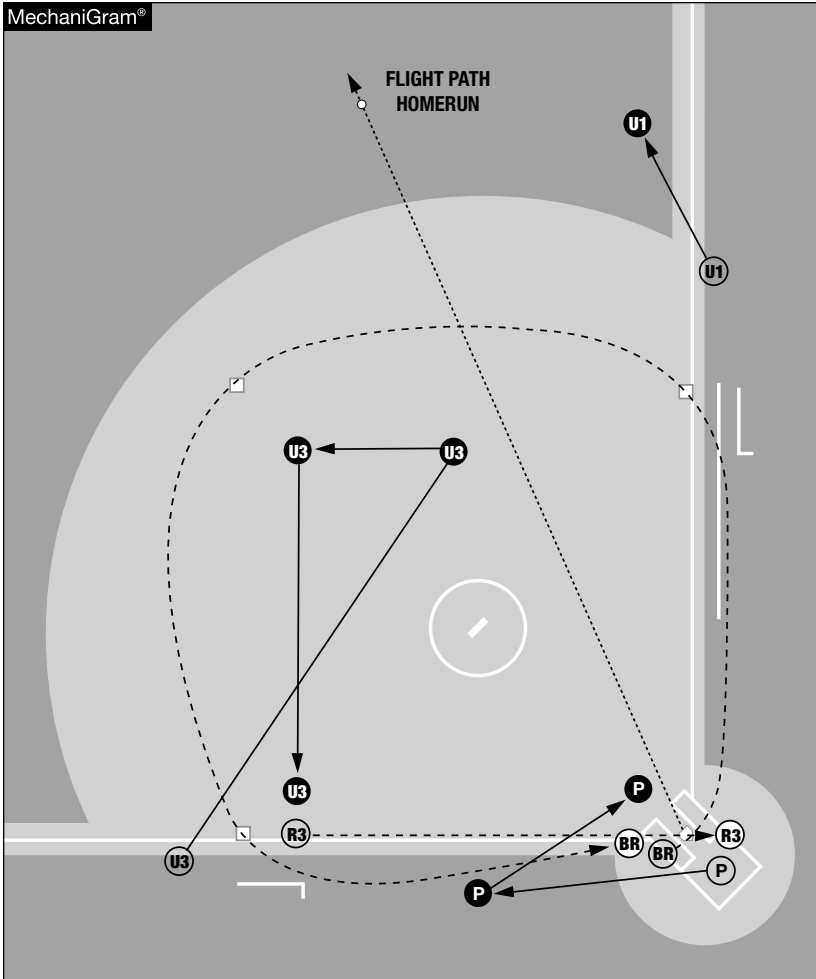

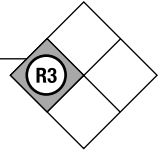

- P:**
- Move to the holding area in foul territory between home plate and third base.
 - After the home run signal, move to an infield position in front of home plate.
 - Make all calls at home plate.
 - After the BR touches home plate, give a ball to the pitcher, catcher or closest infielder.
- U3:**
- Move across the infield.
 - Watch the BR touch first base.
 - Move along with the BR on the inside of the diamond.
 - Watch the BR touch second and third base.



Runner on Third

U3 Chases - Ball is Caught

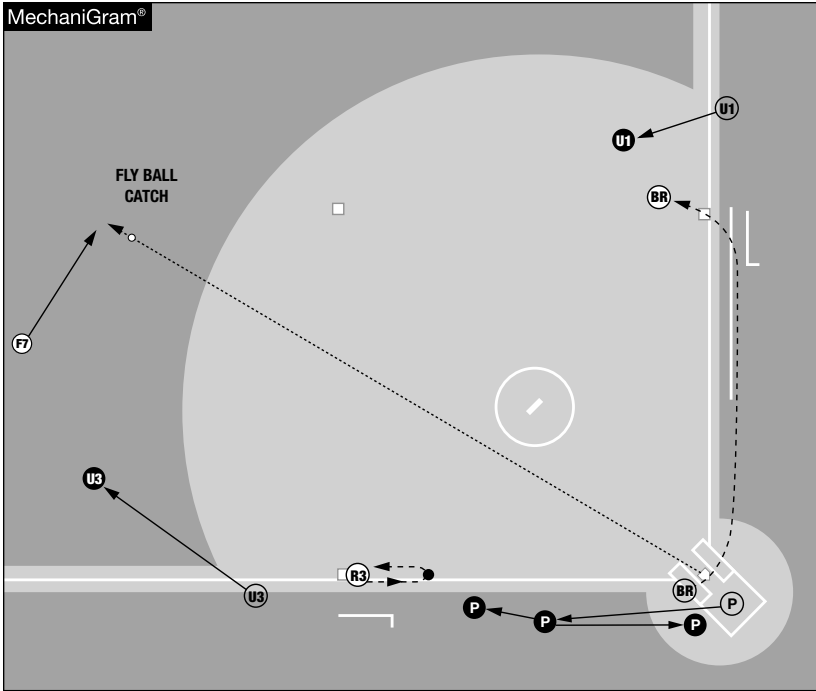

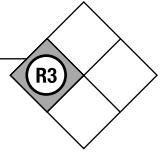

- P:**
- Move towards the holding area between home plate and third base to align yourself with the ball and R3 to see the tag up.
 - Make any calls on R3 at third base and home plate.
- U1:**
- Move into fair territory staying outside the diamond.
 - Make all calls at first base.



Runner on Third

U3 Chases - Ball is Not Caught

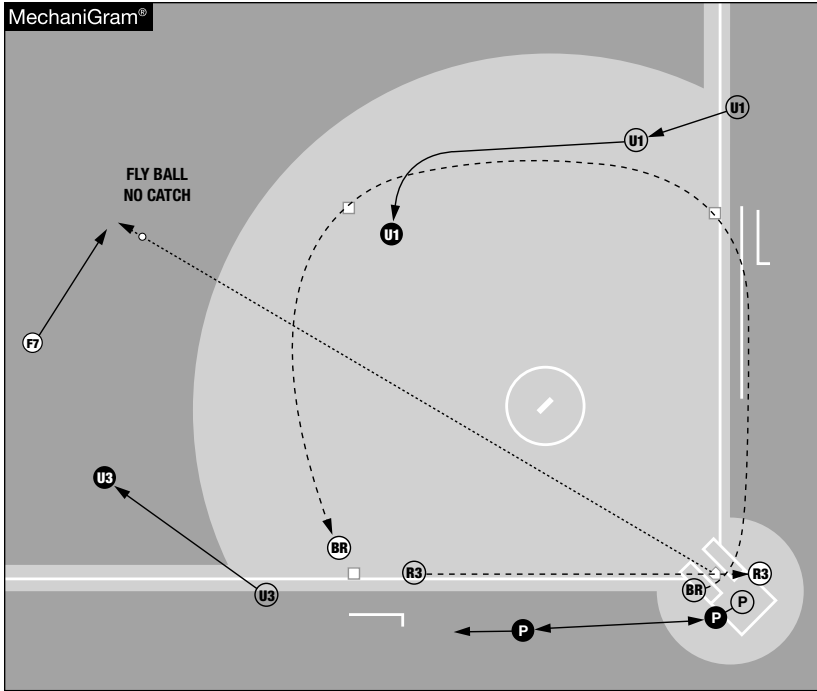

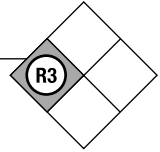

- P:**
- Move toward the holding area in foul territory between home plate and third base.
 - When there will be a play on R3 at home plate move to a position to make all calls at home plate.
 - When R3 scores without a play watch the touch from the holding zone.
 - Remain in the holding zone, commit to all plays on the BR at third base and home plate.
- U1:**
- Move into fair territory outside the diamond, make all calls at first and second base.
 - As the BR approaches second base with the ball still in the outfield, move inside the diamond behind the BR, visually confirm that the plate umpire is prepared to take the BR at third base.



Runner on Third

U3 Chases - Home Run (Out-of-the-Park)

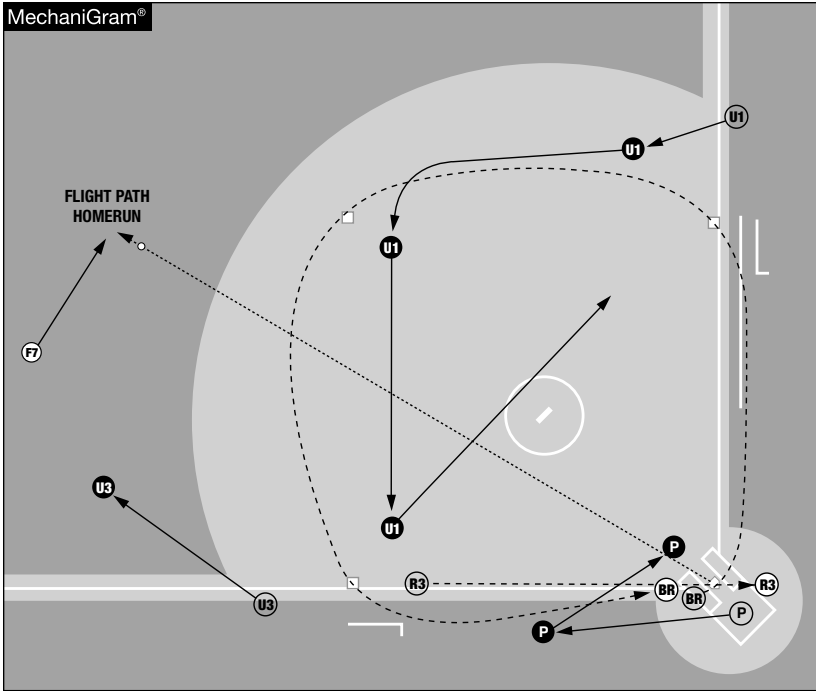

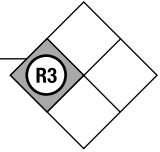

- P:**
- Move to the holding area in foul territory between home plate and third base.
 - After the home run signal, move to an infield position in front of home plate.
 - Make all calls at home plate.
 - After the BR touches home plate, give a ball to the pitcher, catcher or closest infielder.
- U1:**
- Move into fair territory staying outside the diamond.
 - Watch the BR touch first base.
 - As the BR is approaching second base, move inside the diamond behind the runner.
 - Watch the BR touch second and third base.
 - While watching the BR continue to home plate, jog diagonally across the field heading to the next starting position.



Runners on First and Second “Counter-Rotated” Starting Position

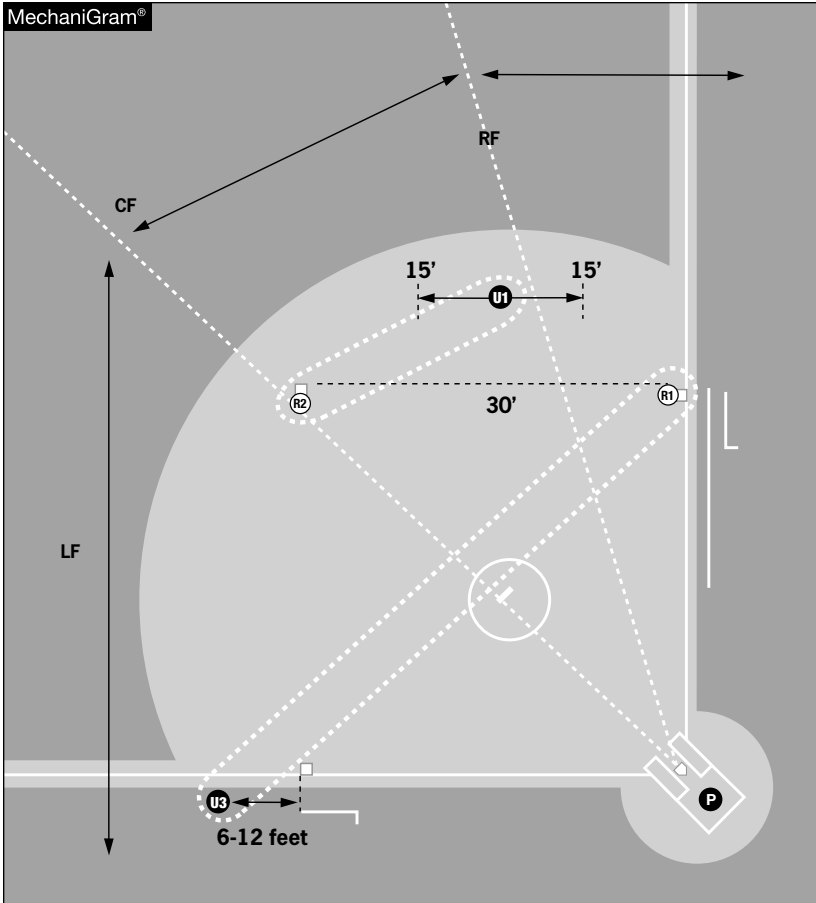

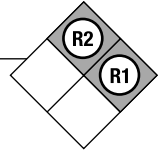

P: Checked Swing – U3.

Fly Ball Coverage Area – Right fielder to the right field dead ball line. All fly balls when no umpire chases.

Tag Up Responsibilities – None.

U1: Before the pitch – Umpire option to come to set prior to the pitch, remain standing during the pitch, or take a step with the pitch anywhere in between 15 feet from second base and 15 feet from first base.

On the pitch - Responsible for watching R2 for leaving the base before the pitch is released.

Checked Swing – None.

Fly Ball Coverage Area – The wedge from the center fielder to right fielder. U1 has the right of first refusal on balls hit to the center fielder.

Tag Up Responsibilities – R1 when no umpire chases. R1 and R2 when no umpire or U3 chases a fly ball from the center fielder to the left field dead ball line.

U3: Before the pitch – Start in a set position, slightly angled towards the infield (opposite baseline between home and first base) completely in foul territory, within four feet of the line, with a clear view of the check swing, 6-12 feet beyond third base.

On the pitch – Responsible for watching R1 for leaving the base before the pitch is released.

Checked Swing – All batters.

Fly Ball Coverage Area – Center fielder to the left field dead ball line.

Tag Up Responsibilities – R2 when no umpire chases a fly ball from the center fielder to the right field dead ball line. R2 and R1 when U1 chases.



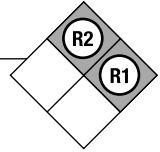

- P:** **WBP** – Complete the verbal and/or signal. Reset out of stance when the pitch is over completing verbal and/or signal. Remain alert to the batter's actions and the catcher for any play.
Pickoff – When the pitch is over, watch the catcher's attempt to throw the ball to either base. Look for batter interference. After the throw is released step out from home plate, clearing the catcher and batter to watch the play at either base.
Steal – When the pitch is over, watch the catcher's attempt to throw the ball to either base. Look for batter interference. After the throw is released step out from home plate, clearing the catcher and batter to watch the play at either base. When a steal results from a passed ball, remain in the plate area, avoiding any throwing lanes. Keep tracking the ball and make any call on the ball (blocked ball, interference, enters dead ball area, etc.).
- U1:** **WBP** – Move out from the set position, move forward a few steps and watch for a possible play or obstruction at both bases. Return to a starting position once the ball is in the pitcher's circle with the pitcher and both runners have returned to their base.
Pickoff – Move out from the set position, move to a primary position, read the play as it develops and adjust positioning as necessary to watch the applied tag or any play at either base.
Steal – Move out from the set position, move to a primary position, read the play as it develops and adjust positioning as necessary to watch the applied tag or any play at second base. When there is no throw, watch R1 approach, touch or round at second base.
- U3:** **WBP** – Stay in a set position and watch for a possible play or obstruction at either base. Return to a starting position once the ball is in the pitcher's circle with the pitcher and both runners have returned to their base.
Pickoff – Move out from the set position and move as needed to watch any play at either base.
Steal – Move out from the set position, read the play as it develops and adjust positioning as necessary to watch the applied tag or any play at third base. When there is no throw, watch R2 approach, touch or round third base.



Runners on First and Second

Hit to the Infield

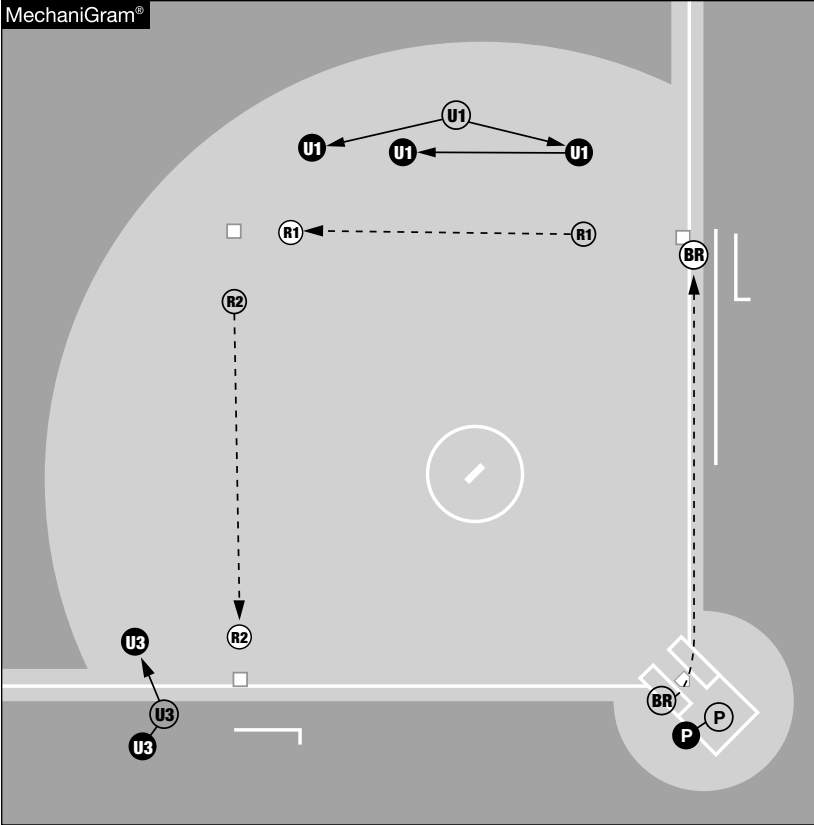

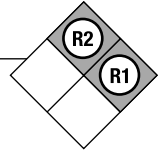

- P:**
- On a throw to first base, move to a first base line extended position.
 - When there is no throw to first base, move to the point of plate holding position.
 - Make all calls at home plate.
- U1:**
- Make all calls at first and second base.
 - When the initial throw is at second base, commit to a primary position for a force play at second base.
 - When a double play is attempted, open up to watch the force play at second base. Immediately turn with the throw to first base, close the distance, and be set to make the call at first base.
 - When the initial throw is at first base, commit to a primary position for a force play at first base. Make the call and quickly glance at second base for a possible tag play on R1.
 - When the initial play is on R2 at third base, stay at a midpoint position, then commit to the second throw in the infield to first or second base.
- U3:**
- Make all calls at third base.



Runners on First and Second

Foul Fly Ball to the Infield Area

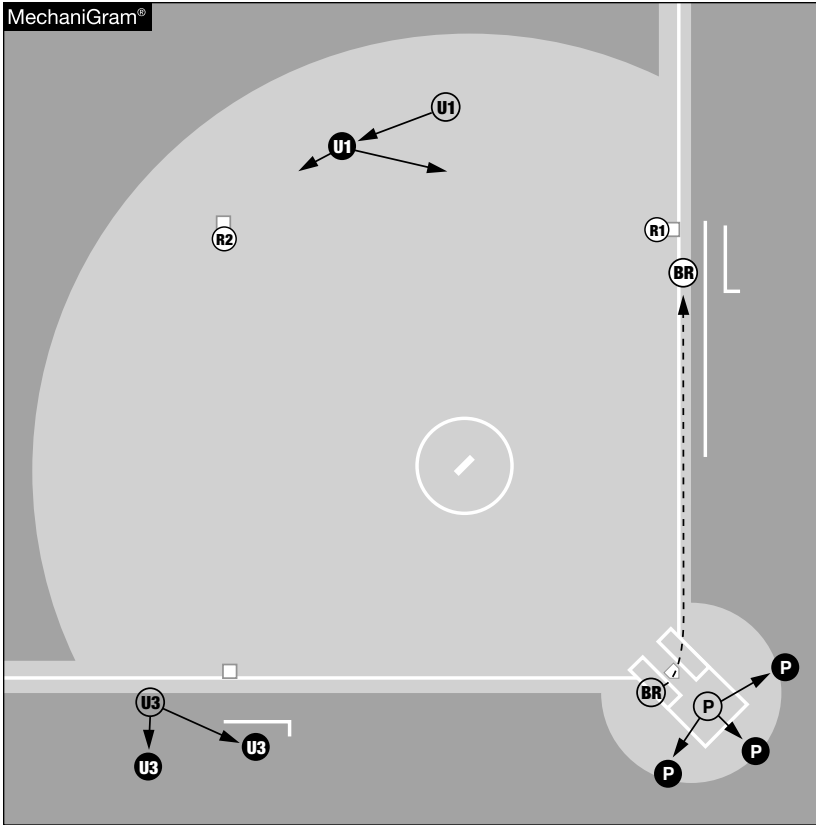

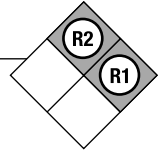

- P:**
- Once the ball is hit, read the catcher. Don't look for the ball first. Allow the catcher to take you to the ball.
 - Open pivot to the catcher's back creating room for the catcher to go to the ball.
 - Be alert to any other infielders attempting to make a play on the ball.
 - Close-down the distance to the play if the infielders are diving, the ball is against the fence or near the dugout area.
 - If U3 is bracketing on the third base side, make the call on the catch/no catch if the play is facing you, the field or the dugout. Otherwise, U3 will make the call, if the play is facing them.
 - The responsibility for the catch/no catch belongs to the plate umpire, if the catch is not facing either umpire.
- U1:**
- Seek a position to watch R2 and R1 tag up with R2 being the priority.
 - Watch R2 and R1 return and make any call at either base.
- U3:**
- When the fly ball is on the third base side, move accordingly in foul territory to bracket the play with the plate umpire.
 - Be alert not to interfere with any infielders attempting to make a play on the ball.
 - Close-down the distance to the play if the infielders are diving, the ball is against the fence or near the dugout area.
 - Make the call on the catch/no catch if the play is facing you. Otherwise, the plate umpire will make the call.
 - After the catch is made, quickly move back to third base and make any call on R2 at third base.



Runners on First and Second

No Chase - Fly Ball/Line Drive - Ball is Caught

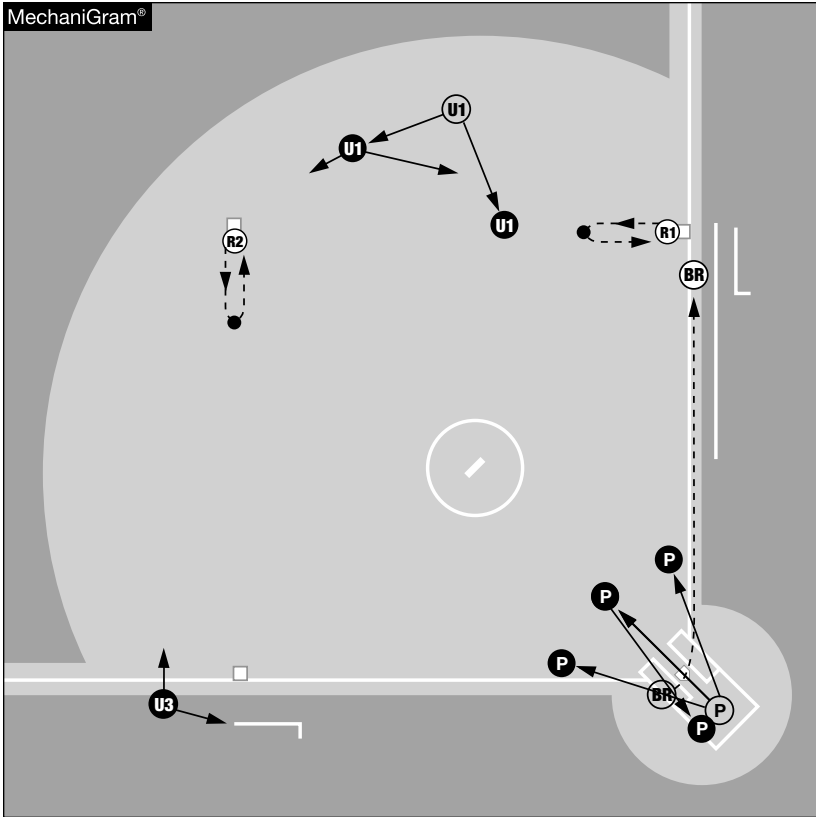

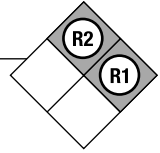

- P:**
- Move into the infield in the direction of the flight of the ball.
 - After the catch, move to the point of plate holding position.
 - Make all calls at home plate.
- U1:**
- Move to align yourself with the ball and R2 on a ball hit between the center fielder and the left field dead ball line to watch the tag up. After the catch, quickly turn to watch R1 tag up.
 - Move to align yourself with the ball and R1 on a ball hit between the center fielder and the right field dead ball line to watch the tag up.
 - Make all calls at first and second base.
- U3:**
- Move to align yourself with the ball and R2 to watch the tag up on a ball hit between the center fielder and the right field dead ball line.
 - Make all calls at third base.





Runners on First and Second

No Chase - Ball is Not Caught

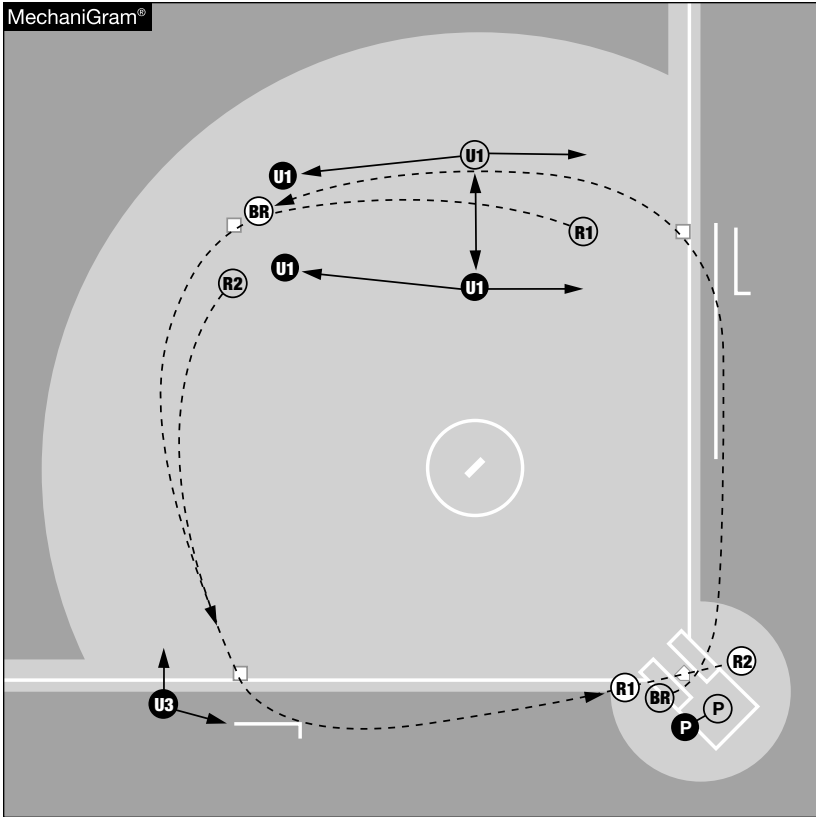

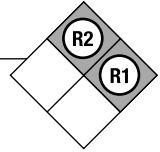

- P:**
- On a throw from right field, move to a first base line extended trail position in foul territory.
 - When there is no throw to first base, move to the point of plate holding position.
 - Make all calls at home plate.
- U1:**
- Make all calls at first and second base.
- U3:**
- Make all calls at third base.



Runners on First and Second No Chase - Home Run (Out-of-the-Park)

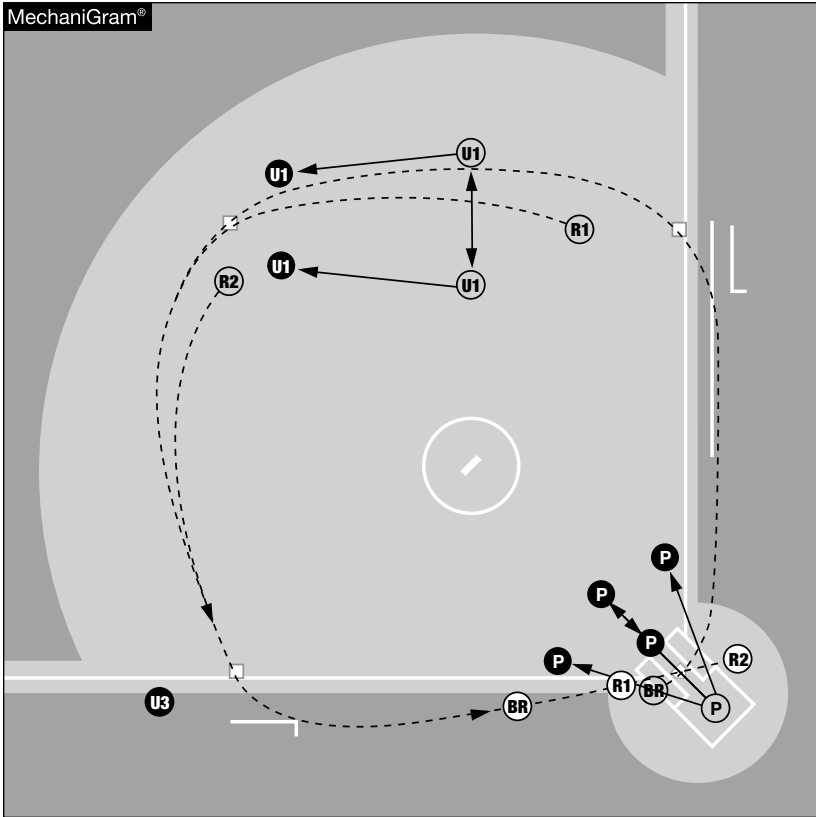

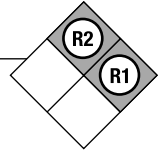

- P:**
- Move into the infield in the direction of the flight of the ball.
 - After signaling the home run, move to an infield position in front of home plate.
 - Make all calls at home plate.
 - After the BR touches home plate, give a ball to the pitcher, catcher or closest infielder.
- U1:**
- Watch R1 touch second base and the BR touch first and second base.
 - As the runner continues on to home plate, move briskly toward your next starting position.
- U3:**
- Watch all runners touch third base.



Runners on First and Second

U1 Chases - Ball is Caught

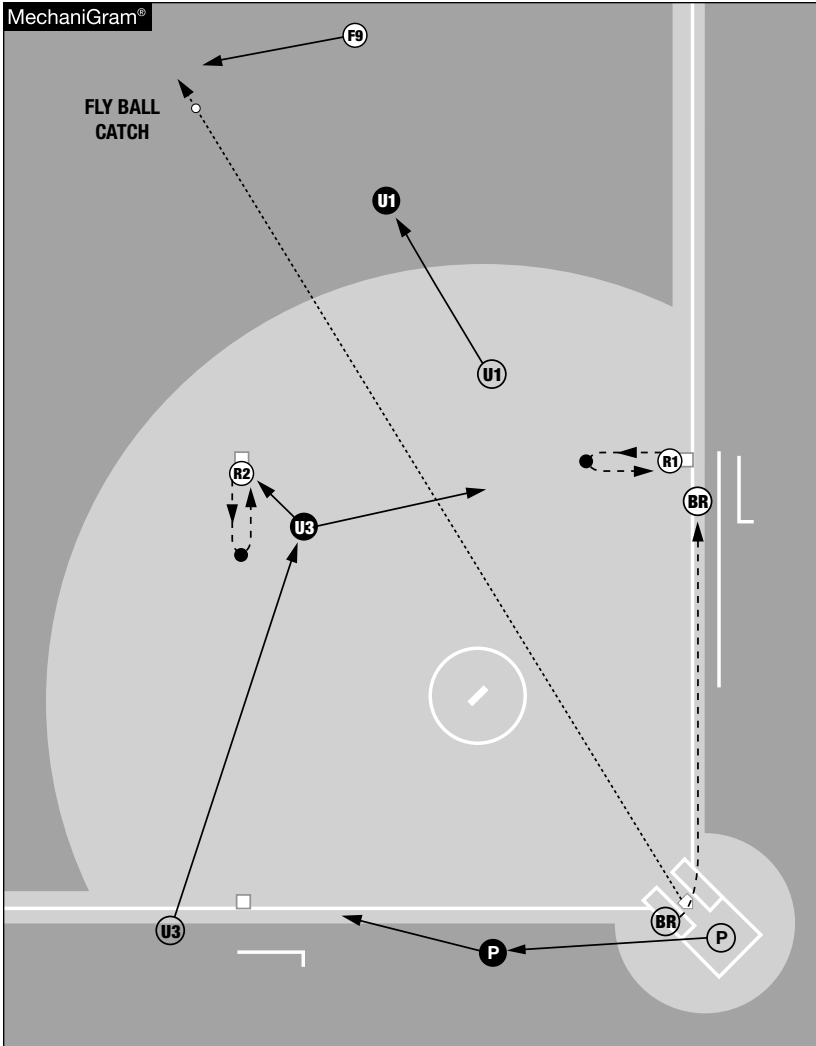

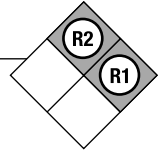

- P:**
- Move to the holding area in foul territory between home and third base.
 - Make all calls on R2 at third base and home plate.
- U3:**
- Move across the infield to align yourself with the ball and R2 to watch the tag up.
 - After the catch, quickly turn to watch R1 tag up.
 - Make all calls at first and second base.



Runners on First and Second

U1 Chases - Ball is Not Caught

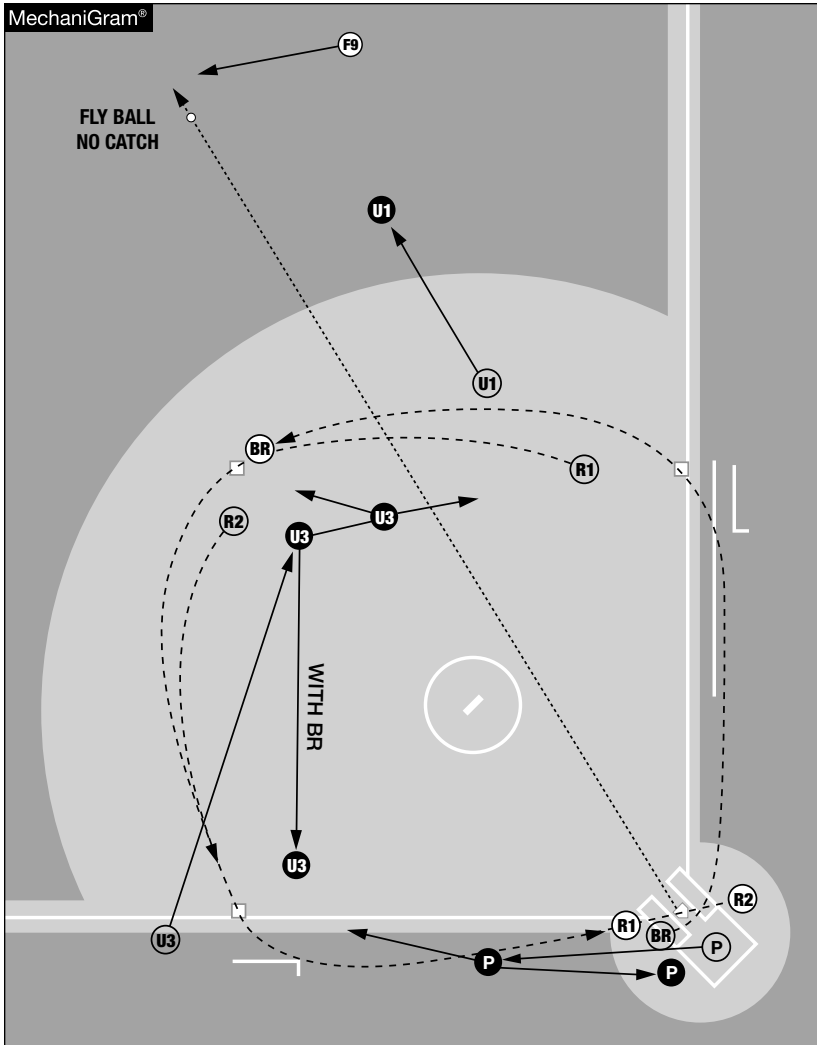

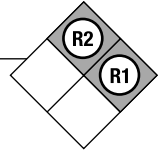

- P:**
- Move to the holding area in foul territory between home plate and third base.
 - Make all calls on R2 and R1 at third base.
 - Make all calls at home plate.
- U3:**
- Move across the infield.
 - Make all calls on R1 at second base.
 - If R1 advances to third base with a play being made on R2 at home, make all calls on R1 at third base.
 - Make all calls on the BR at first, second and third base.



Runners on First and Second

U1 Chases - Home Run (Out-of-the-Park)

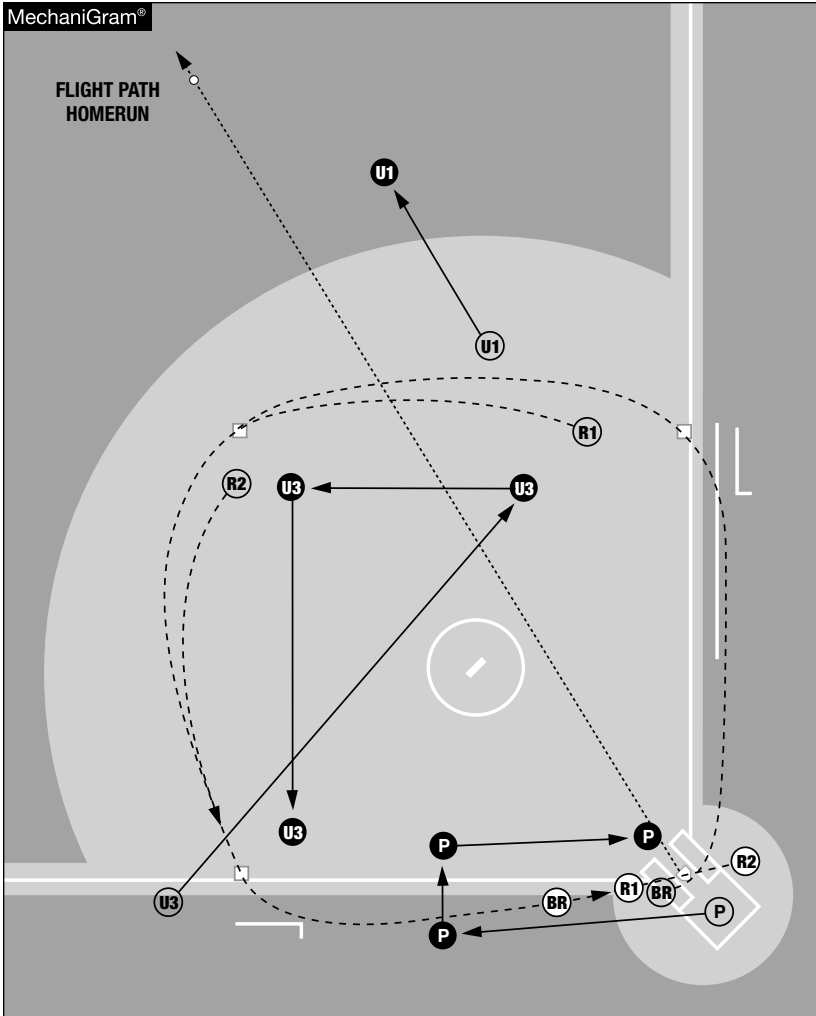

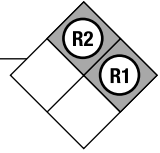

- P:**
- Move to the holding area in foul territory between home plate and third base.
 - After the home run signal, move to an infield position between home and third base.
 - While watching R2 and R1 touch third base, move to an infield position in front of home plate.
 - Make all calls at home plate.
 - After the BR touches home plate, give a ball to the pitcher, catcher or closest infielder.
- U3:**
- Move across the field between second and first base.
 - Watch R1 touch second base.
 - Watch the BR touch first, second and third base.



Runners on First and Second

U3 Chases - Ball is Caught

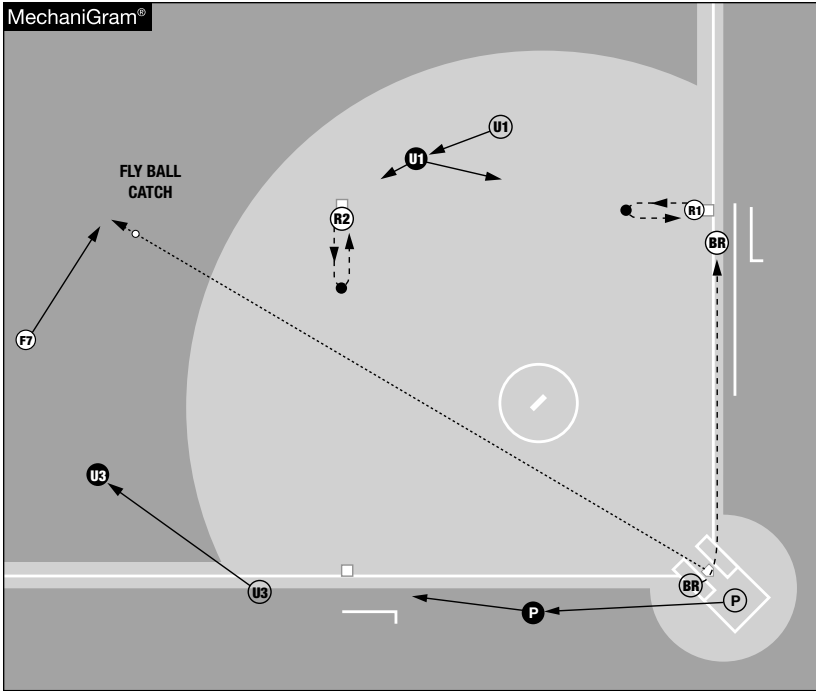

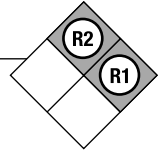

- P:**
- Move to the holding area in foul territory between home plate and third base.
 - Make all calls at third base on R2.
 - Make all calls at home plate.
- U1:**
- Move to align yourself with the ball and R2 to watch the tag up.
 - After the catch, quickly turn to watch R1 tag up.
 - Make all calls at first and second base.



Runners on First and Second

U3 Chases - Ball is Not Caught

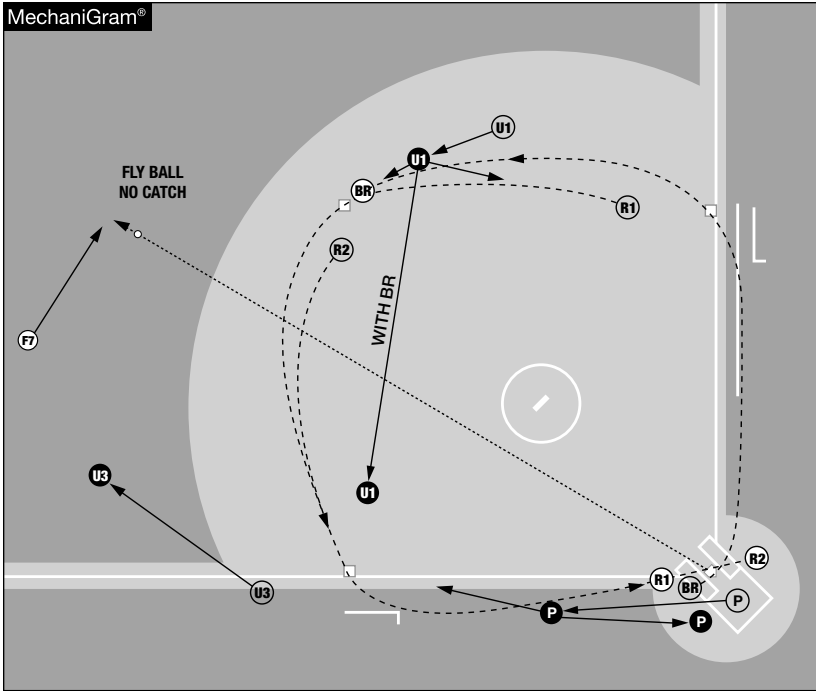

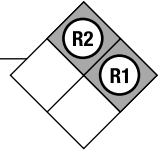

- P:**
- Move to the holding area in foul territory between home plate and third base.
 - Make all calls on R2 and R1 at third base.
 - Make all calls at home plate.
- U1:**
- Make all calls on R1 at second base.
 - If R1 advances to third base with a play being made on R2 at home, make all calls on R1 at third base.
 - Make all calls on the BR at first and second base.
 - As the BR approaches second base with the ball still in the outfield, move inside the diamond behind the BR.
 - Make all calls on the BR at third base.



Runners on First and Second

U3 Chases - Home Run (Out-of-the-Park)

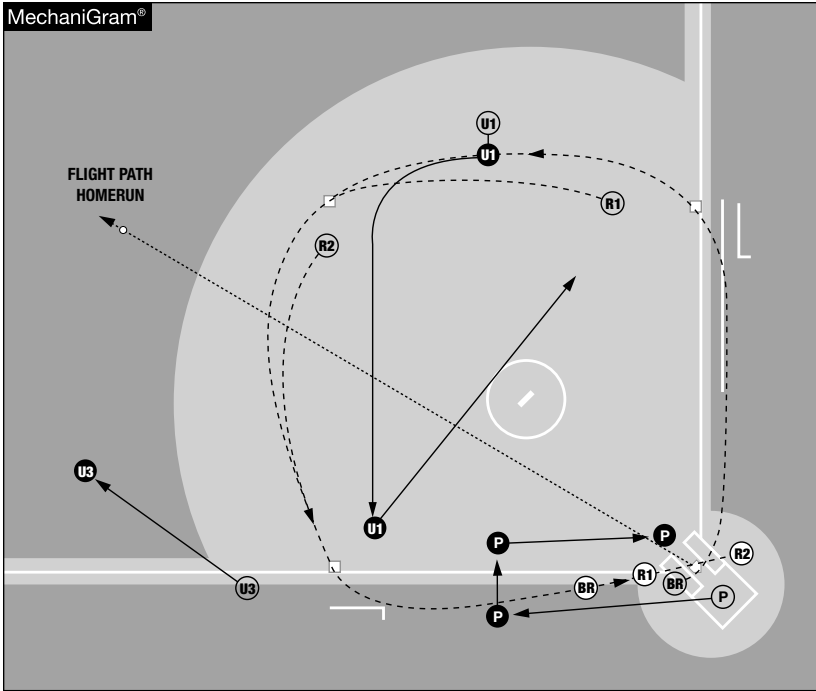

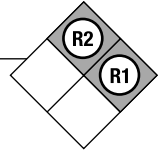

- P:**
- Move to the holding area in foul territory between home plate and third base.
 - After the home run signal, move to an infield position between home and third base.
 - While watching R2 and R1 touch third base, move to an infield position in front of home plate.
 - Make all calls at home plate.
 - After the BR touches home plate, give a ball to the pitcher, catcher or closest infielder.
- U1:**
- Watch R1 touch second base and the BR touch first base.
 - As the BR approaches second base, move inside of the diamond behind the BR.
 - Watch the BR touch second and third base.
 - While watching the BR continue to home plate, jog diagonally across the field heading to the next starting position.



Runners on First and Third “Counter-Rotated” Starting Position

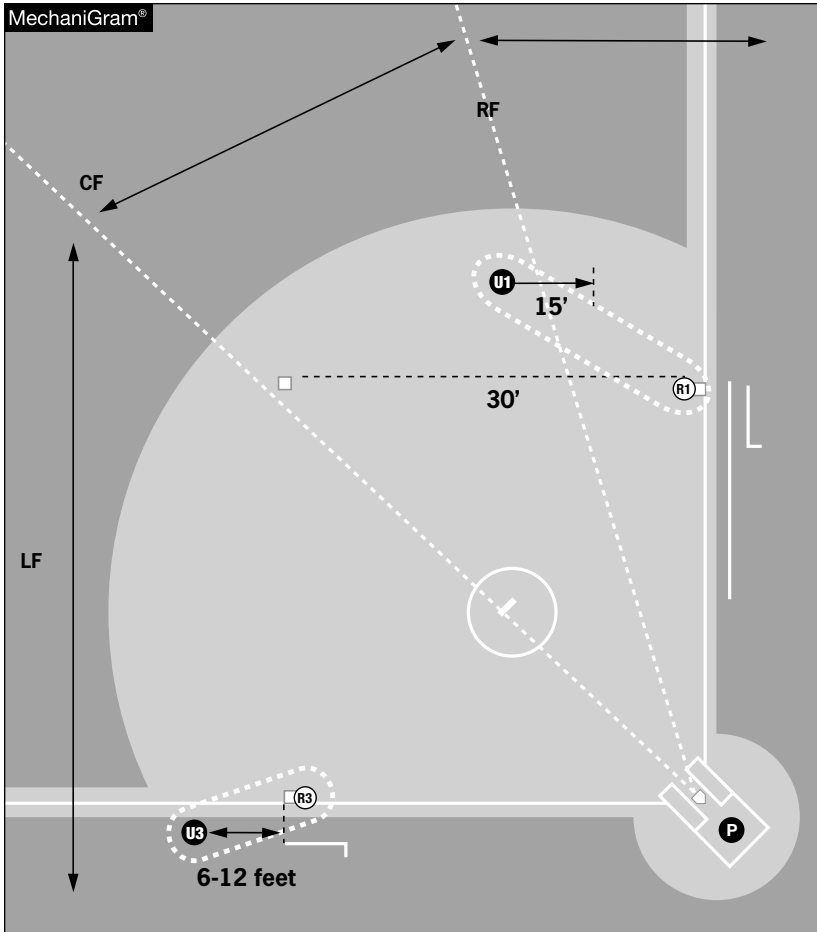

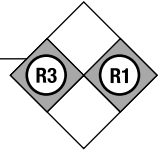

- P: Checked Swing – U3.**
Fly Ball Coverage Area – Right fielder to the right field dead ball line. When no umpire chases, all fly balls.
Tag Up Responsibilities – R3 when U3 or U1 chases.
- U1: Before the pitch -** Umpire option to come to set prior to the pitch, remain standing during the pitch, or take a step with the pitch between 15 feet from first base and the 30-foot midpoint between first and second base.
On the pitch – Responsible for watching R1 for leaving the base before the pitch is released.
Checked Swing – None.
Fly Ball Coverage Area – The wedge from the center fielder to right fielder. U1 has the right of first refusal on balls hit to the center fielder.
Tag Up Responsibilities – R1 when no umpire chases or U3 chases.
- U3: Before the pitch –** Start in a set position, slightly angled towards the infield (opposite baseline between home and first base) completely in foul territory, within four feet of the line, with a clear view of the check swing, 6-12 feet beyond third base.
On the pitch – Responsible for watching R3 for leaving the base before the pitch is released.
Checked Swing – All batters.
Fly Ball Coverage Area – Center fielder to the left field dead ball line.
Tag Up Responsibilities – R3 when no umpire chases. R1 when U1 chases.



Runners on First and Third

R1 & R3 – Working Between Pitches (WBP) Pickoff – Steal

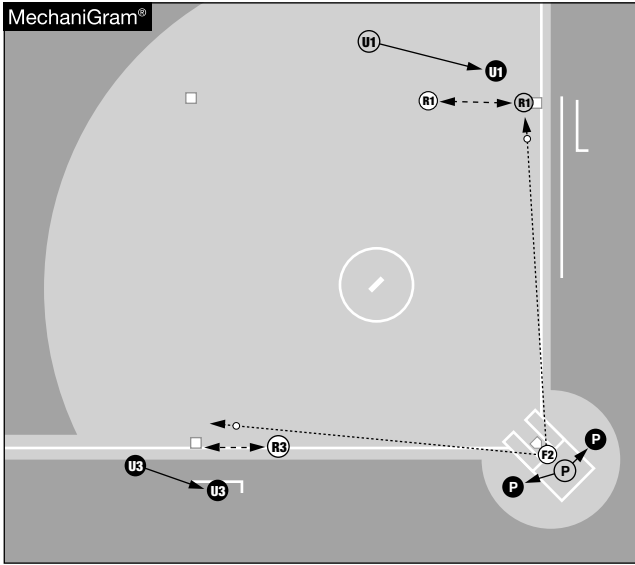

Pickoff at Third – Pickoff at First

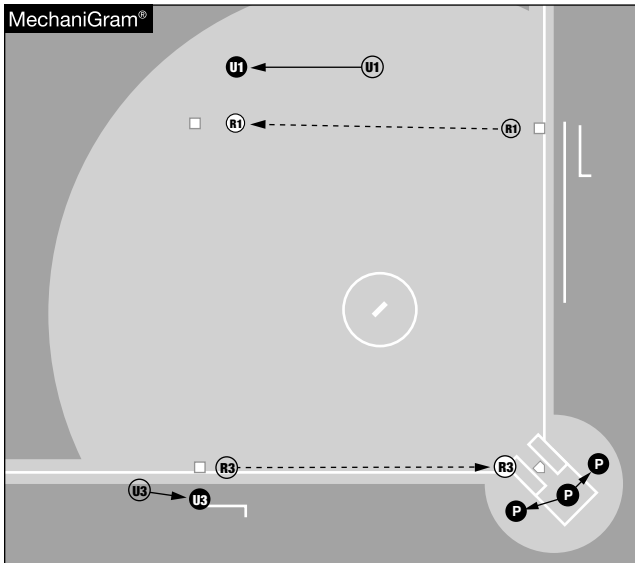

Steal from Third – Steal from First



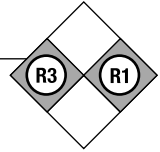

- P: WBP** – Complete the verbal and/or signal. Reset out of stance when the pitch is over. Remain alert to the batter’s actions and the catcher for any play.
Pickoff – When the pitch is over, watch the catcher’s attempt to throw the ball to either base. Look for batter interference. After the throw is released, step out from home plate, clearing the catcher and batter to watch the play at either base.
Steal – For R3, when the pitch is over, read the play as it develops and adjust positioning as necessary to watch the applied tag or any play at home plate. For R1, after the throw is released, step out from home plate, clearing the catcher and batter to watch the play at second base. If the steal results from a passed ball, remain in the plate area, avoiding any throwing lanes. Keep tracking the ball and make any call on the ball (blocked ball, interference, enters dead ball area, etc.).
- U1: WBP** – Move out from the set position, move toward first base and watch for a possible play or obstruction. When the ball is in the pitcher’s circle with the pitcher and both runners have returned to base, return to starting position.
Pickoff – For R1, move out of the set position, move to a primary position, read the play as it develops and adjust positioning as necessary to watch the applied tag or any play at first base. For R3, move out of the set position and move as needed to watch the play at third base.
Steal – Move out from the set position and move with R1 toward second base. Read the play as it develops and adjust positioning as necessary to watch the applied tag or any play at second base. When there is no throw, watch R1 approach, touch or round at second base.
- U3: WBP** – Stay in a set position and watch for a possible play or obstruction at third base. Return to a starting position once the ball is in the pitcher’s circle and R3 has returned to the base.
Pickoff – For R3, move out of the set position, read the play as it develops and adjust positioning as necessary to watch the applied tag or any play at third base. For R1, move out of the set position and move as needed to watch the play at first base.
Steal – For R3, move out of the set position and move to the baseline in foul territory. Stop and watch any play at home plate and be prepared to give help if requested. For R1, move out of the set position and move as needed to watch the play at second base.



Runners on First and Third

Hit to the Infield

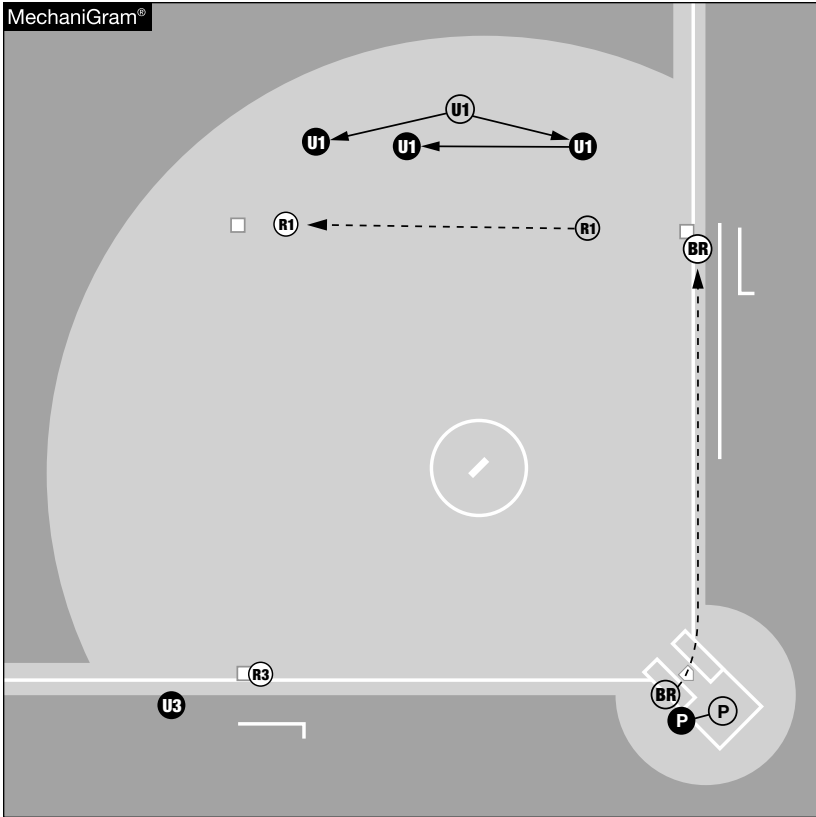

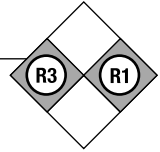

- P:**
- On a throw to first base, move to a first base line extended trail position.
 - When there is no throw to first, move to the point of plate holding position.
 - Make all calls at home plate.
- U1:**
- Make all calls at first and second base.
 - When the initial throw is at second base, commit to a primary position for a force play at second base.
 - When a double play is attempted, open up to watch the force play at second base. Immediately turn with the throw to first base, close the distance, and be set to make the call at first base.
 - When the initial throw is at first base, commit to a primary position for a force play at first base. Make the call and quickly glance at second base for possible tag play on R1.
 - When the initial play is on R2 at third base, stay at a midpoint position, then commit to the second throw in the infield to first or second base.
- U3:**
- Make all calls at third base.



Runners on First and Third

Foul Fly Ball to the Infield Area

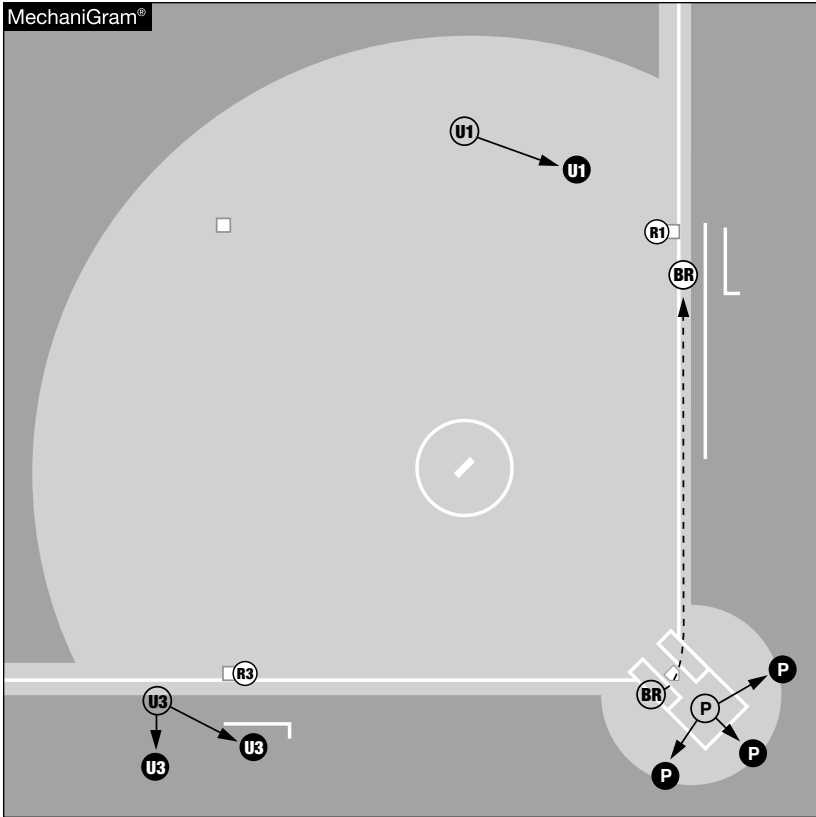

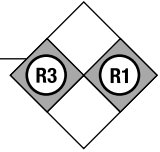

- P:**
- Once the ball is hit, read the catcher. Don't look for the ball first. Allow the catcher to take you to the ball.
 - Open pivot to the catcher's back creating room for the catcher to go to the ball.
 - Close-down the distance to the play if the infielders are diving, the ball is against the fence or near the dugout area.
 - If U3 is bracketing on the third base side, make the call on the catch/no catch if the play is facing you, the field or the dugout. Otherwise, U3 will make the call, if the play is facing them.
 - The responsibility for the catch/no catch belongs to the plate umpire, if the catch is not facing either umpire.
 - If U3 makes the catch call, be prepared to make the tag-up call on R3 or any tag play at third base. After the catch is made, quickly move back to the point of plate holding position and make any call on R3 at the plate].
- U1:**
- Seek a position to watch R1 tag up.
 - Watch R1 return and make any call at first or second base, if R1 advances to second.
- U3:**
- Remain close to third base to watch R3 tag up.
 - Watch R3 return and make any call at third base.
 - If bracketing and the plate umpire has the catch/no catch call, focus on tag up responsibilities on R3. If you have the call, the plate umpire will focus on tag up responsibilities on R3.



Runners on First and Third

No Chase - Fly Ball/Line Drive - Ball is Caught

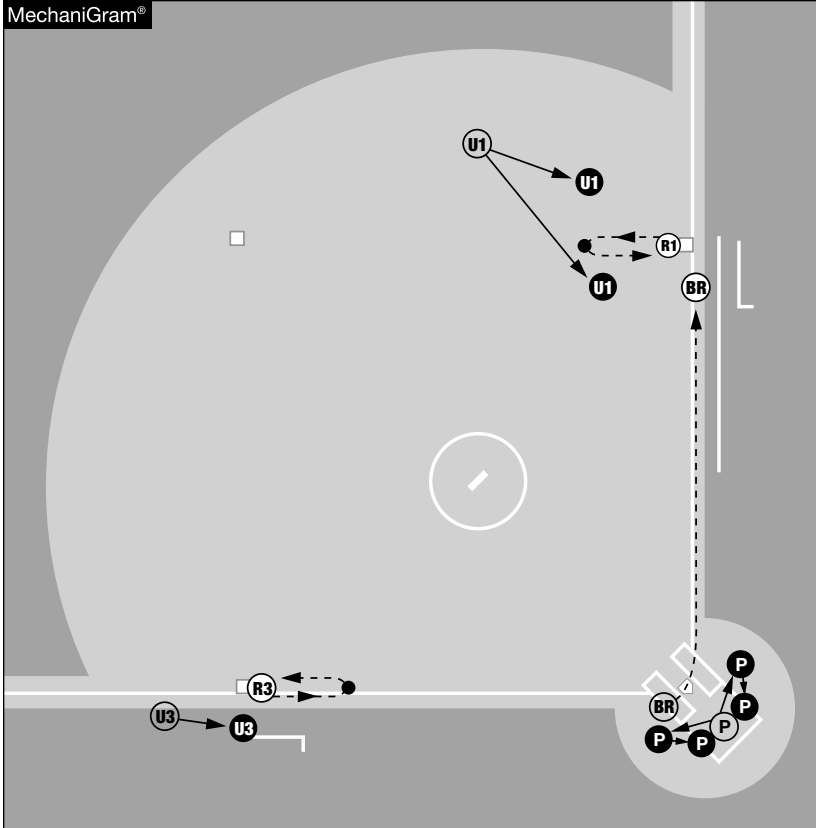

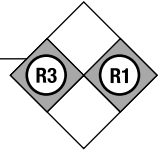

- P:**
- Stay in foul territory or straddle the base line at home plate.
 - After the catch, move to the point of plate holding position.
 - Make all calls at home plate.
- U1:**
- Move to align yourself with the ball and R1 to watch the tag up.
 - Make all calls at first and second base.
- U3:**
- Move to align yourself with the ball and R3 to watch the tag up.
 - Make all calls at third base.



Runners on First and Third

No Chase - Ball is Not Caught

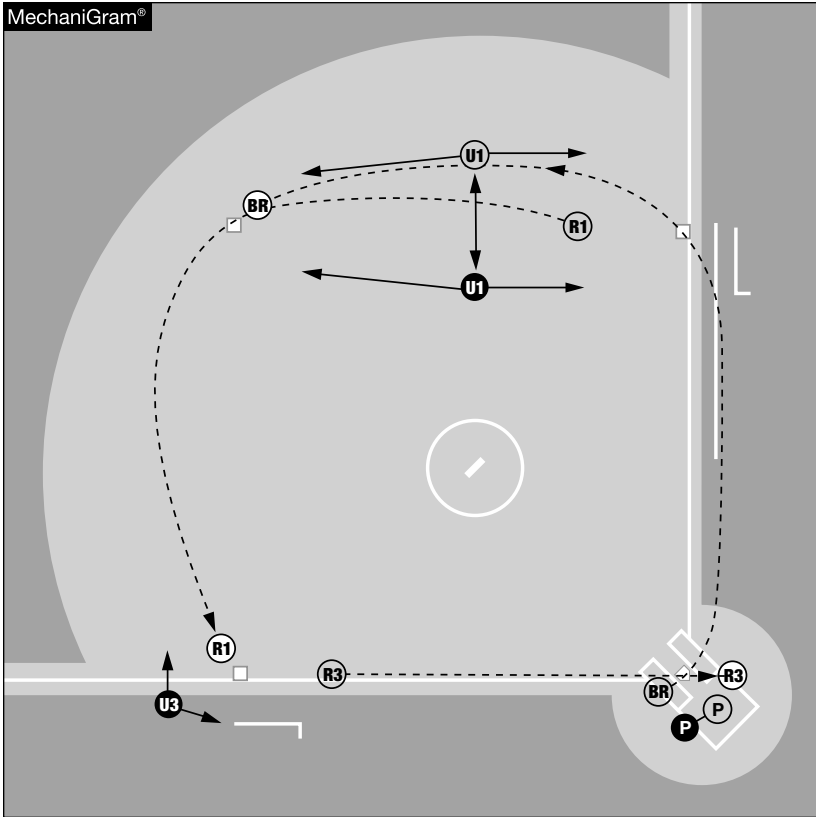

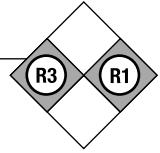

- P:**
- On a throw from right field, move to a first base line extended trail position in foul territory.
 - When there is no throw to first base, move to the point of plate holding position.
 - Make all calls at home plate.
- U1:**
- Make all calls at first and second base.
- U3:**
- Make all calls at third base.



Runners on First and Third No Chase - Home Run (Out-of-the-Park)

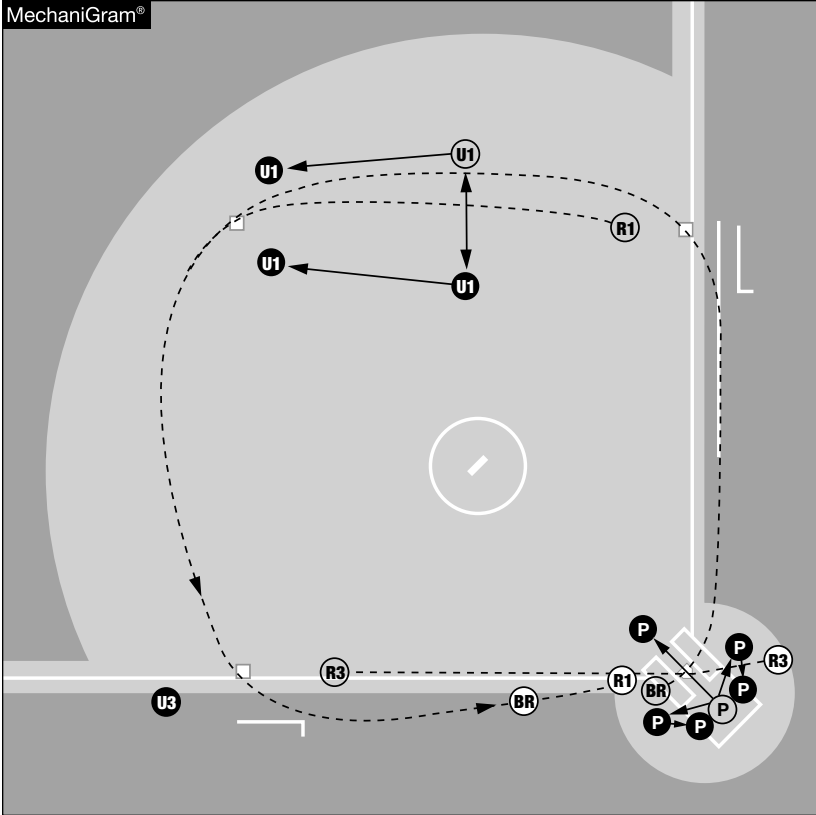

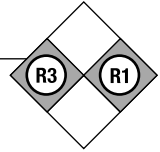

- P:**
- Stay in foul territory or straddle the base line at home plate.
 - After signaling home run, move to an infield position in front of home plate.
 - Make all calls at home plate.
 - After the BR touches home plate, give a ball to the pitcher, catcher or closest infielder.
- U1:**
- Watch R1 touch second base
 - Watch the BR touch first and second base.
 - As the BR continues on to home plate, move briskly toward your next starting position.
- U3:**
- Watch all runners touch third base.



Runners on First and Third

U1 Chases - Ball is Caught

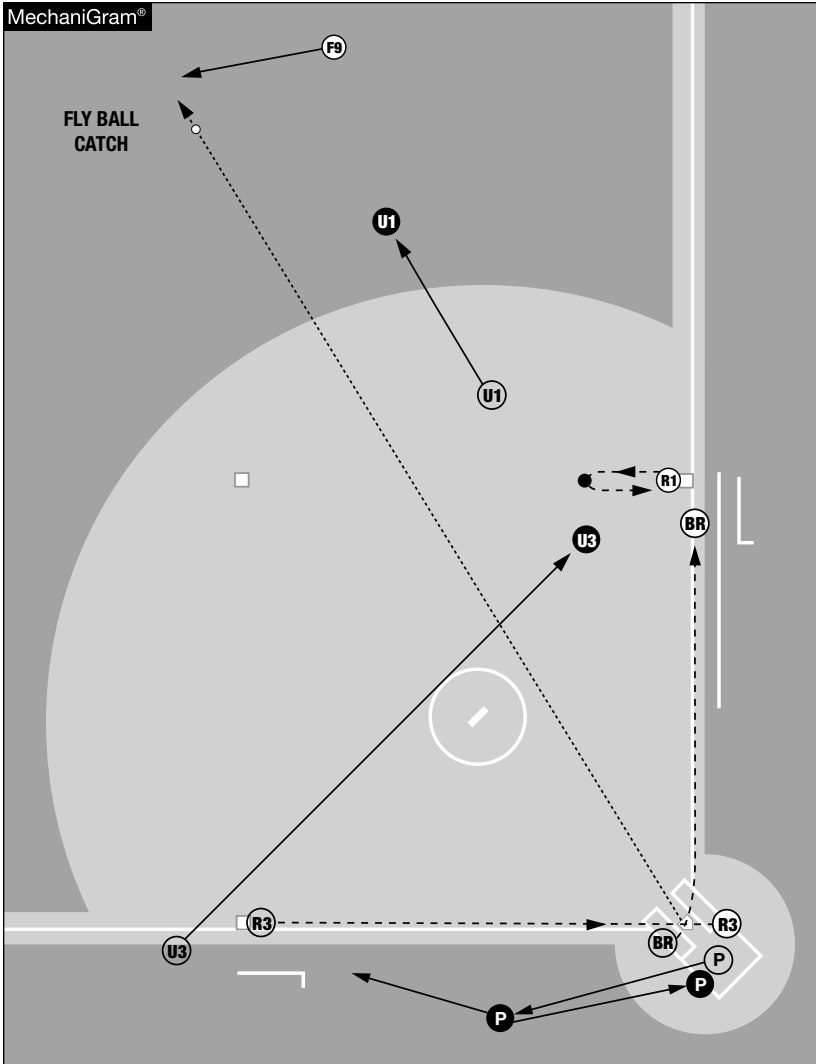

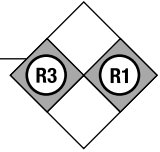

- P:**
- Move towards the holding area between home plate and third base to align yourself with the ball and R3 to see the tag up.
 - Make all calls on R3 at third base or home plate.
- U3:**
- Move across the diamond to align yourself with the ball and R1 to watch the tag up.
 - Make all calls on R1 at first, second or third base.



Runners on First and Third

U1 Chases - Ball is Not Caught

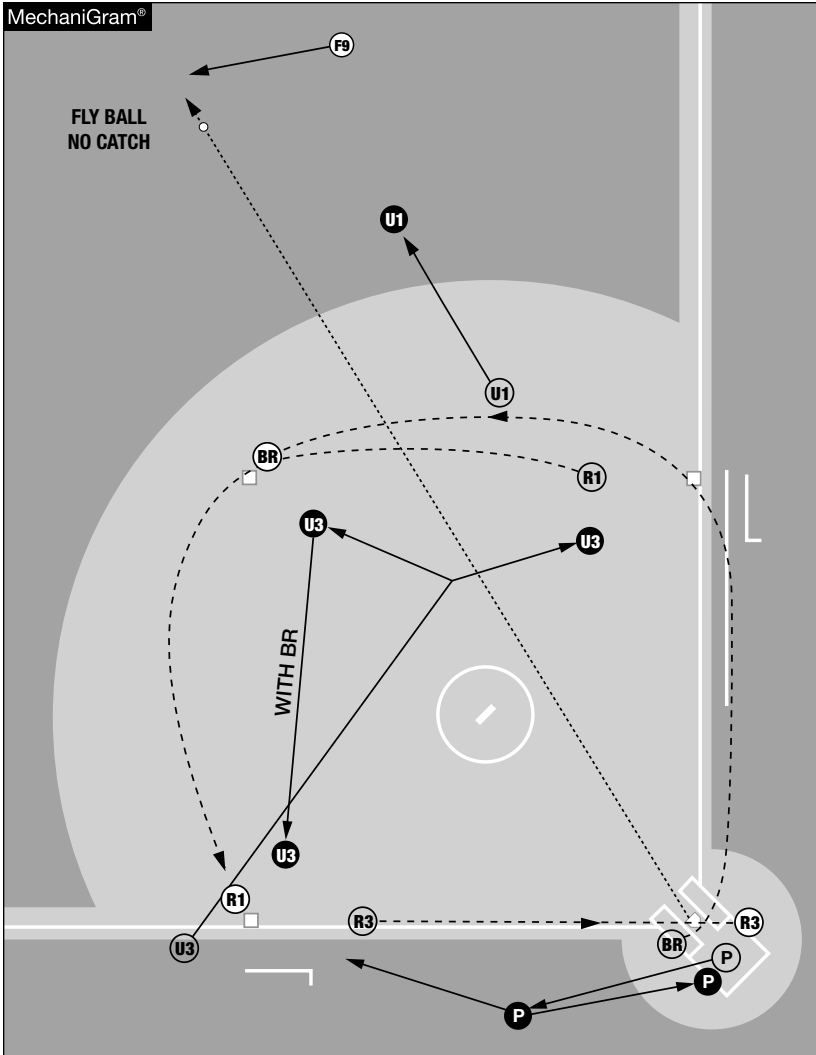

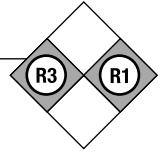

- P:**
- Move to the holding area in foul territory between home plate and third base.
 - Make all calls on R3 and R1 on third base.
 - Make all calls at home plate.
- U3:**
- Move across the infield.
 - Make all calls at first and second base.
 - Make all calls on the BR at third base.



Runners on First and Third

U1 Chases - Home Run (Out-of-the-Park)

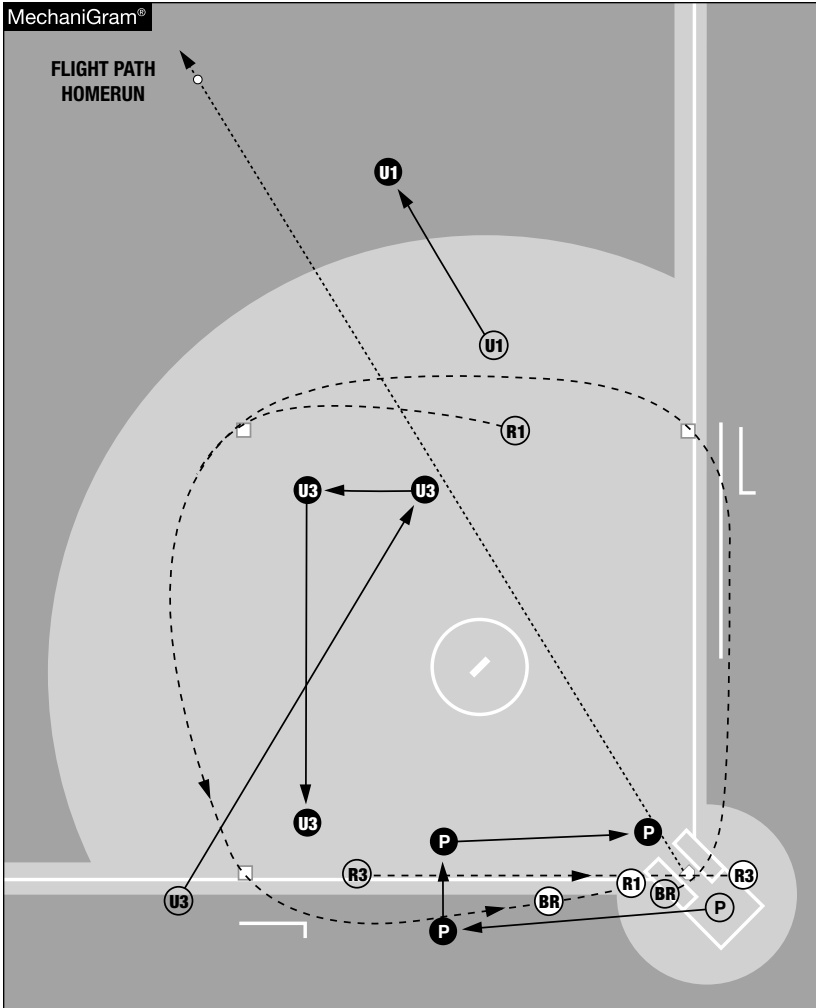

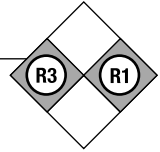

- P:**
- Move to the holding area in foul territory between home plate and third base.
 - After the home run signal, move to an infield position between home and third base, while watching R3 touch home plate and R1 touch third base. Move to an infield position in front of home plate.
 - Make all calls at home plate.
 - After the BR touches home plate, give a ball to the pitcher, catcher or closest infielder.
- U3:**
- Move across the infield.
 - Watch R1 touch second base.
 - Watch the BR touch first, second and third base.



Runners on First and Third

U3 Chases - Ball is Caught

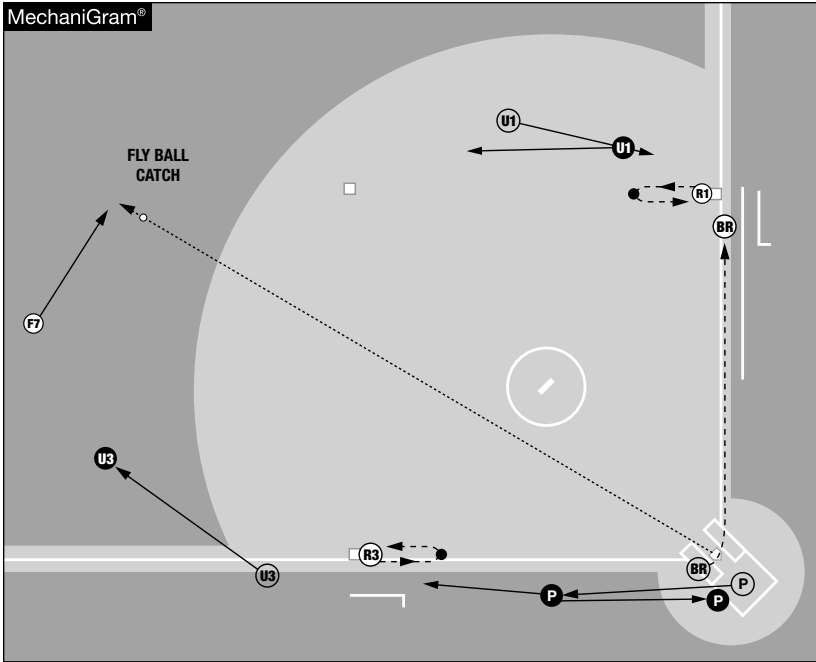

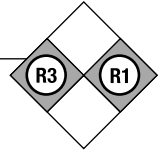

- P:**
- Move towards the holding area between home plate and third base to align yourself with the ball and R3 to see the tag up.
 - Make all calls on R3 at third base or home plate.
- U1:**
- Move to align yourself with the ball and R1 to watch the tag up.
 - Make all calls on R1 at first, second, or third base.



Runners on First and Third

U3 Chases - Ball is Not Caught

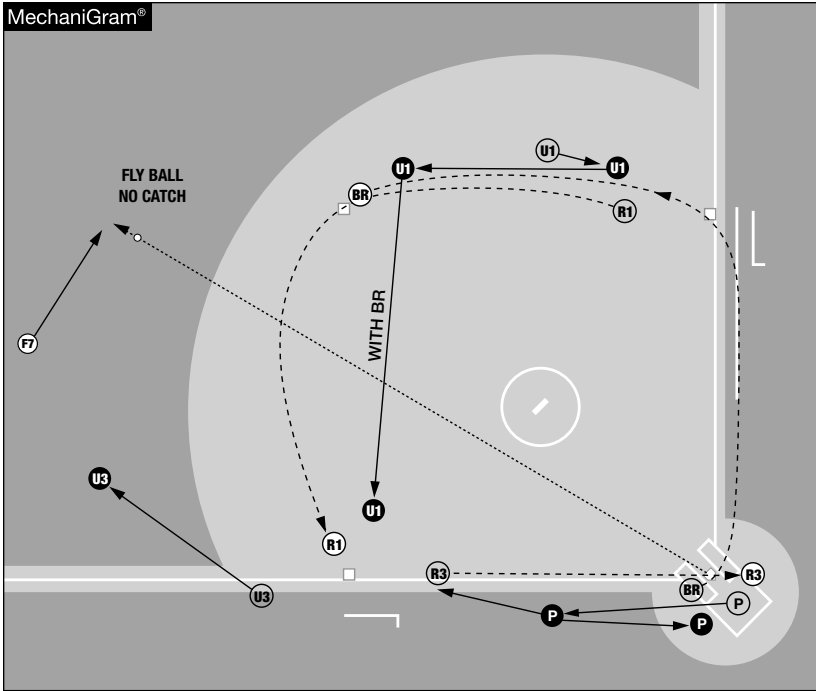

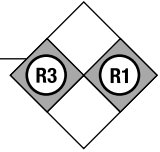

- P:**
- Move to the holding area in foul territory between home plate and third base.
 - Make all calls on R3 and R1 at third base.
 - Make all calls at home plate.
- U1:**
- Make all calls at first and second base.
 - As the BR approaches second base with the ball still in the outfield, move inside the diamond behind the BR.
 - Make all calls on the BR at third base.



Runners on First and Third

U3 Chases - Home Run (Out-of-the-Park)

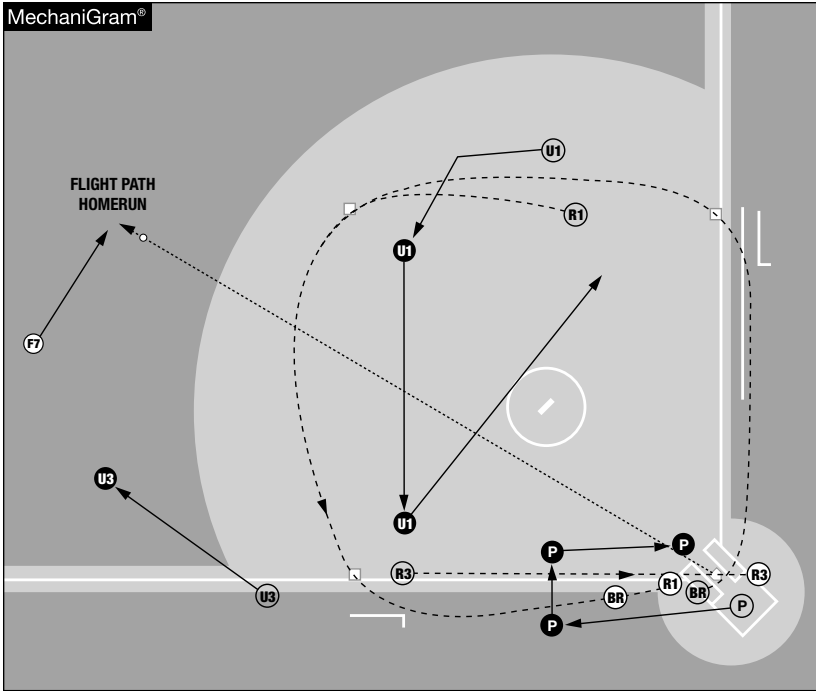

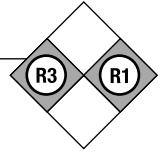

- P:**
- Move to the holding area in foul territory between home plate and third base.
 - After the home run signal, move to an infield position between home and third base, while watching R3 touch home plate and R1 touch third base. Move to an infield position in front of home plate.
 - Make all calls at home plate.
 - After the BR touches home plate, give a ball to the pitcher, catcher or closest infielder.
- U1:**
- Watch R1 touch second base.
 - Watch the BR touch first base.
 - As the BR is approaching second base, move inside the diamond behind the BR, watching the BR touch second and third base.
 - While watching the BR continue to home plate, jog diagonally across the field heading to the next starting position.



Runners on Second and Third “Counter-Rotated” Starting Position

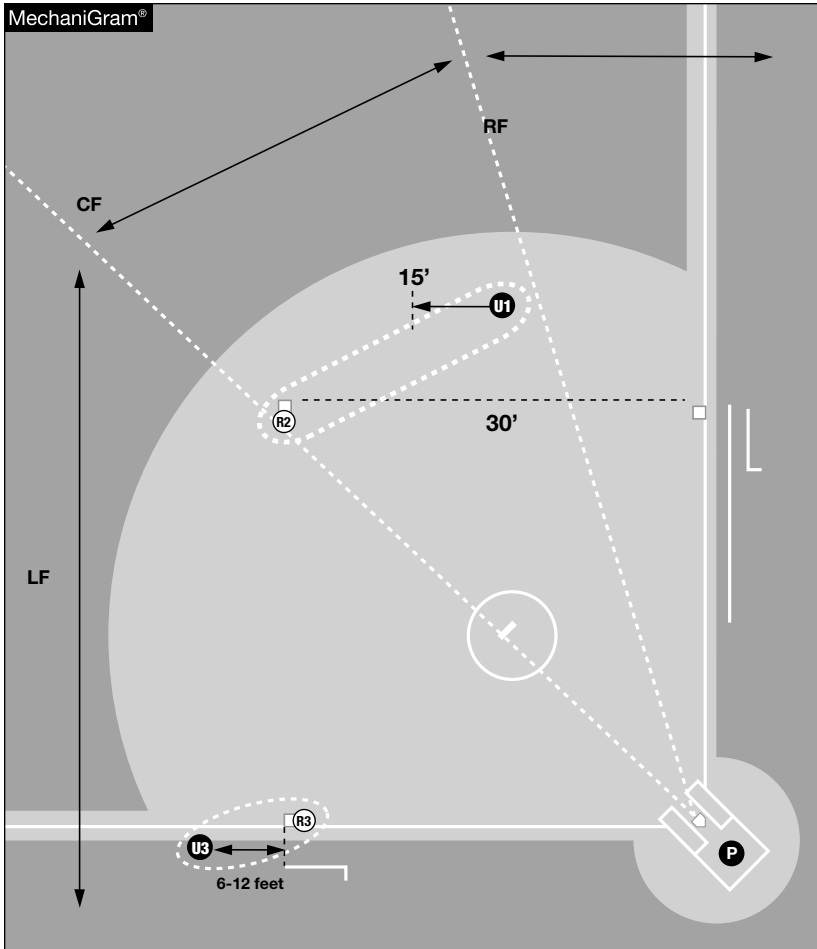

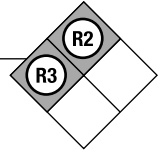

- P: Checked Swing** – U3.
Fly Ball Coverage Area – Right fielder to the right field dead ball line. When no umpire chases, all fly balls.
Tag Up Responsibilities – R3 when U3 or U1 chases.
- U1: Before the pitch** – Umpire option to come to set prior to the pitch, remain standing during the pitch, or take a step with the pitch between 15 feet from second base and the 30-foot midpoint between first and second base.
On the pitch – Responsible for watching R2 for leaving the base before the pitch is released.
Checked Swing – None.
Fly Ball Coverage Area – The wedge from the center fielder to right fielder. U1 has the right of first refusal on balls hit to the center fielder.
Tag Up Responsibilities – R2 when no umpire chases or U3 chases a fly ball from the center fielder to the left field dead ball line.
- U3: Before the pitch** – Start in a set position, slightly angled towards the infield (opposite baseline between home and first base), completely in foul territory, within four feet of the line, with a clear view of the check swing, 6-12 feet beyond third base.
On the pitch – Responsible for watching R3 for leaving the base before the pitch is released.
Checked Swing – All batters.
Fly Ball Coverage Area – Center fielder to the left field dead ball line.
Tag Up Responsibilities – R3 on a fly ball hit from the center fielder to the left field dead ball line when no umpire chases. R2 when U1 chases. R3 and R2 when no umpire chases a fly ball from the center fielder to the right field dead ball line.





Runners on Second and Third

R2 & R3 - Working Between Pitches (WBP) Pickoff - Steal

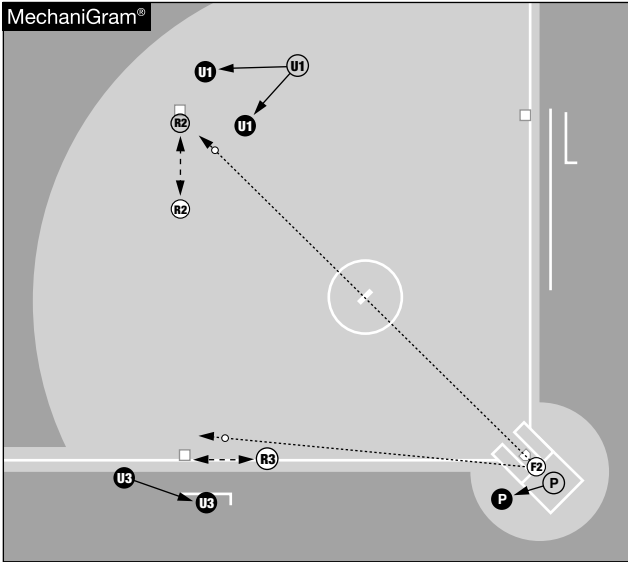

Pickoff at Third – Pickoff at Second

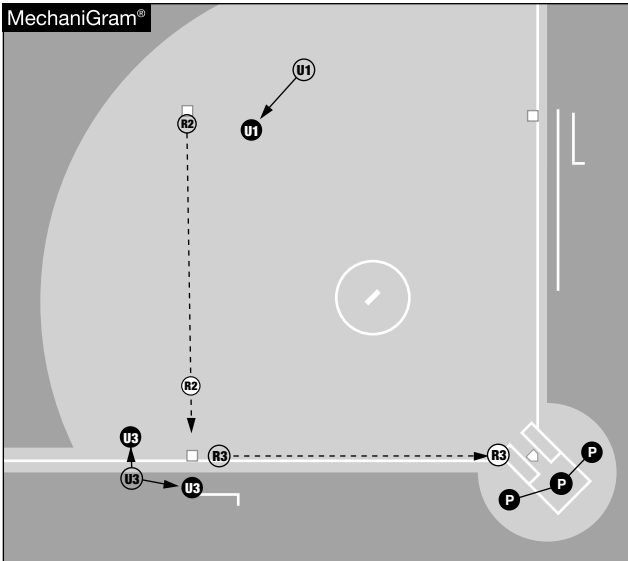

Steal from Third – Steal from Second



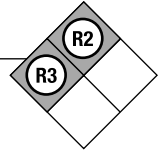

- P: WBP** – Complete the verbal and/or signal. Reset out of stance when the pitch is over. Remain alert to the batter's actions and the catcher for any play.
- Pickoff** – When the pitch is over, watch the catcher's attempt to throw the ball to either base. Look for batter interference. After the throw is released, step out from home plate, clearing the catcher and batter to watch the play at either base.
- Steal** – When the pitch is over, read the play as it develops and adjust positioning as necessary to watch the applied tag or any play at home plate on any runner. When a steal results from a passed ball, remain in the plate area, avoiding any throwing lanes. Keep tracking the ball and make any call on the ball (blocked ball, interference, enters dead ball area, etc.).
- U1: WBP** – Move out of the set position, move toward second base and watch for a possible play or obstruction. Return to a starting position once the ball is in the pitcher's circle with the pitcher and both runners have returned to their base.
- Pickoff** – Move out of the set position, move to a primary position, read the play as it develops and adjust positioning as necessary to watch the applied tag or any play at second base.
- Steal** – Move out of the set position and move as needed to watch any play at third base or home plate.
- U3: WBP** – Stay in a set position and watch for a possible play or obstruction at third base. Return to a starting position once the ball is in the pitcher's circle with the pitcher and both runners have returned to their base.
- Pickoff** – Move out of the set position, read the play as it develops and adjust positioning as necessary to see the applied tag or any play at third base.
- Steal** – For R3, move out of the set position and move as needed to watch any play at home plate. Be prepared to give help if requested. For R2, adjust positioning for a tag play as it develops at third base and make the call.



Runners on Second and Third

Hit to the Infield

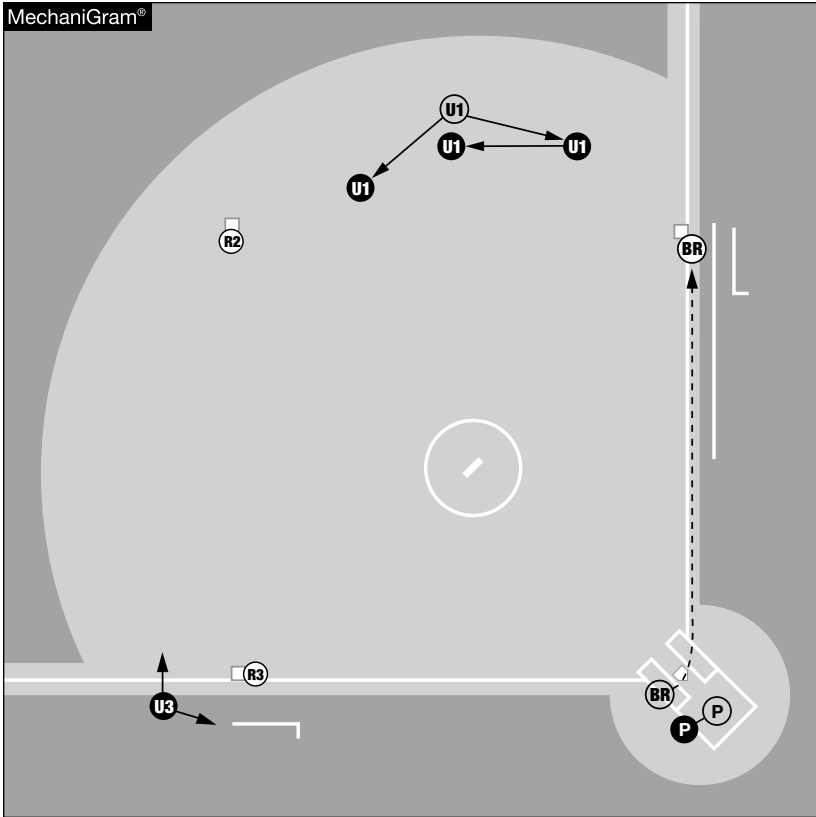

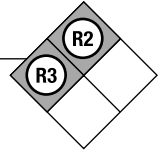

- P:**
- On a throw to first base, move to a first base line extended position.
 - When there is no throw to first base, move to the point of plate holding position.
 - Make all calls at home plate.
- U1:**
- Make all calls at first and second base.
 - When the initial throw is to first base, commit to a primary position for a force play at first base.
 - When the initial play is on R2, commit to a primary position for tag on R2 at second base.
 - When the initial play is on R2 at third base or R3 at home plate, stay at a midpoint position, then commit to the second throw in the infield to first or second base.
- U3:**
- Make all calls at third base.



Runners on Second and Third

Foul Fly Ball to the Infield Area

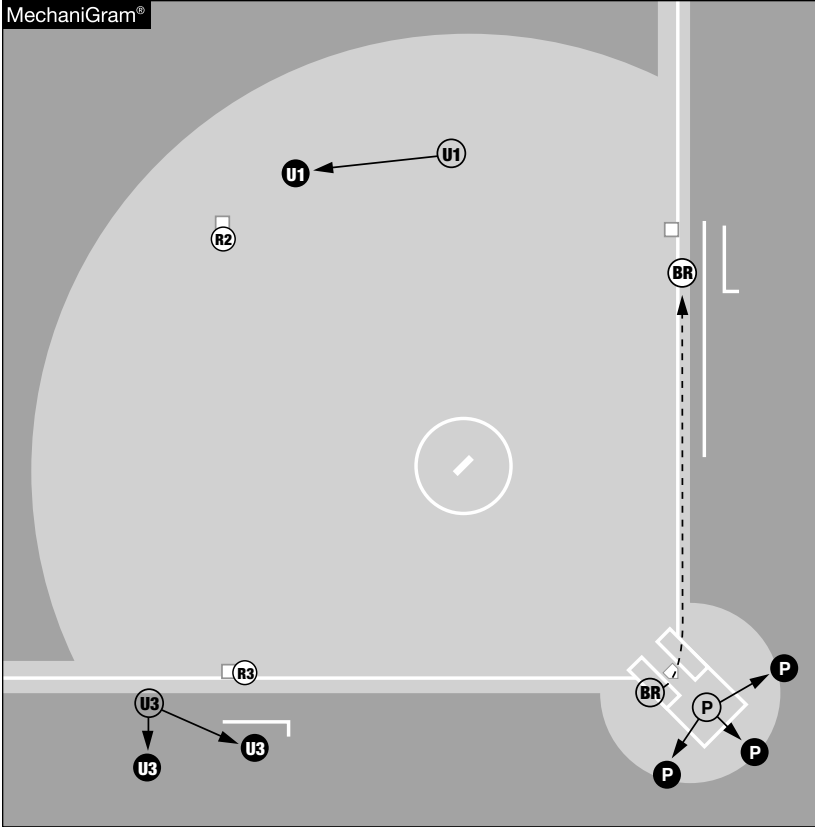

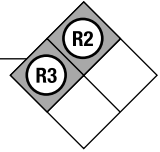

- P:**
- Once the ball is hit, read the catcher. Don't look for the ball first. Allow the catcher to take you to the ball.
 - Open pivot to the catcher's back creating room for the catcher to go to the ball.
 - Close-down the distance to the play if the infielders are diving, the ball is against the fence or near the dugout area.
 - If U3 is bracketing on the third base side, make the call on the catch/no catch if the play is facing you, the field or the dugout. Otherwise, U3 will make the call, if the play is facing them.
 - The responsibility for the catch/no catch belongs to the plate umpire, if the catch is not facing either umpire.
 - If U3 makes the catch call, be prepared to make the tag-up call on R3 at third base or any tag play on R3 at third base. After the catch is made, quickly move back to the point of plate holding position and make any call on R3 at home plate.
- U1:**
- Seek a position to watch R2 tag up.
 - Make all calls at second base.
- U3:**
- Remain close to third base to watch R3 tag up.
 - Watch R3 return and make any call at third base.
 - If bracketing and the plate umpire has the catch/no catch call, focus on tag up responsibilities on R3. If you have the call, the plate umpire will focus on tag up responsibilities on R3.





Runners on Second and Third

No Chase - Fly Ball/Line Drive -
Ball is Caught

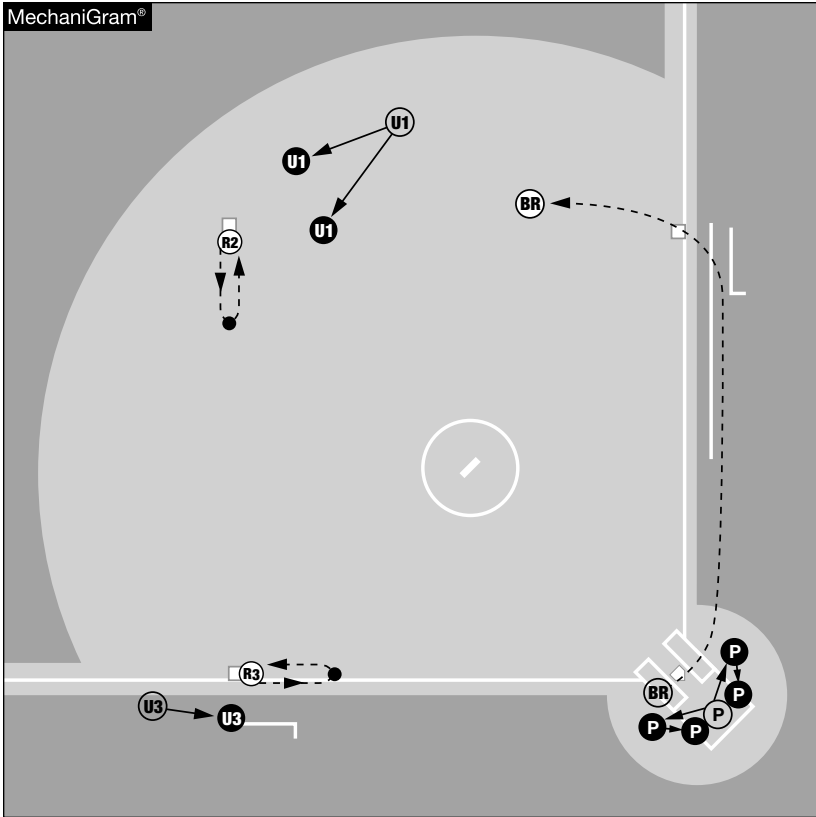

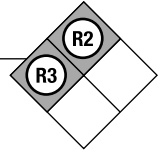

- P:**
- Stay in foul territory or straddle the base line at home plate.
 - After the catch, move to the point of plate holding position.
 - Make all calls at home plate.
- U1:**
- Move to align yourself with the ball and R2 on a ball hit between the center fielder and the left field dead ball line to watch the tag up.
 - Make all calls at second base.
- U3:**
- Move to align yourself with the ball and R3 on all fly balls and R2 on fly balls from the center fielder to the right field dead ball line to watch the tag up.
 - Make all calls at third base.



Runners on Second and Third

No Chase - Ball is Not Caught

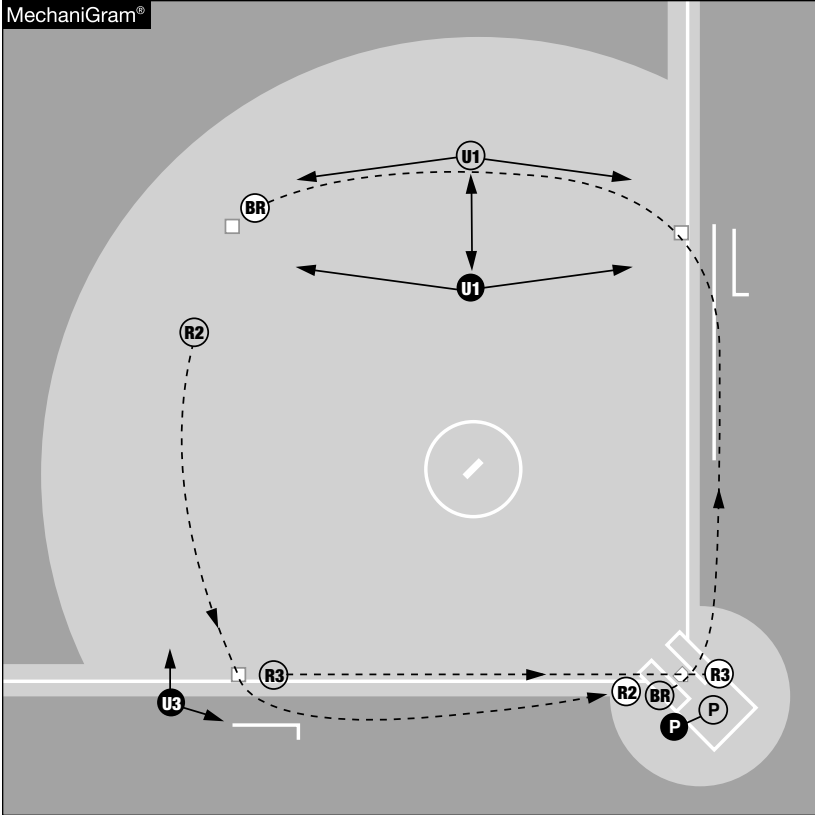

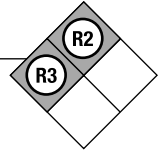

- P:**
- On a throw from right field, move to a first base line extended trail position in foul territory.
 - When there is no throw to first base, move to the point of plate holding position.
 - Make all calls at home plate.
- U1:**
- Make all calls at first or second base.
- U3:**
- Make all calls at third base.
 - When R2 advances to home plate and the ball is still in the outfield, look at U1 with the BR. If they are heading to second base, hold your position. If the BR reverses direction back to first base, run hard to a primary position at second base and communicate to U1.



Runners on Second and Third No Chase - Home Run (Out-of-the-Park)

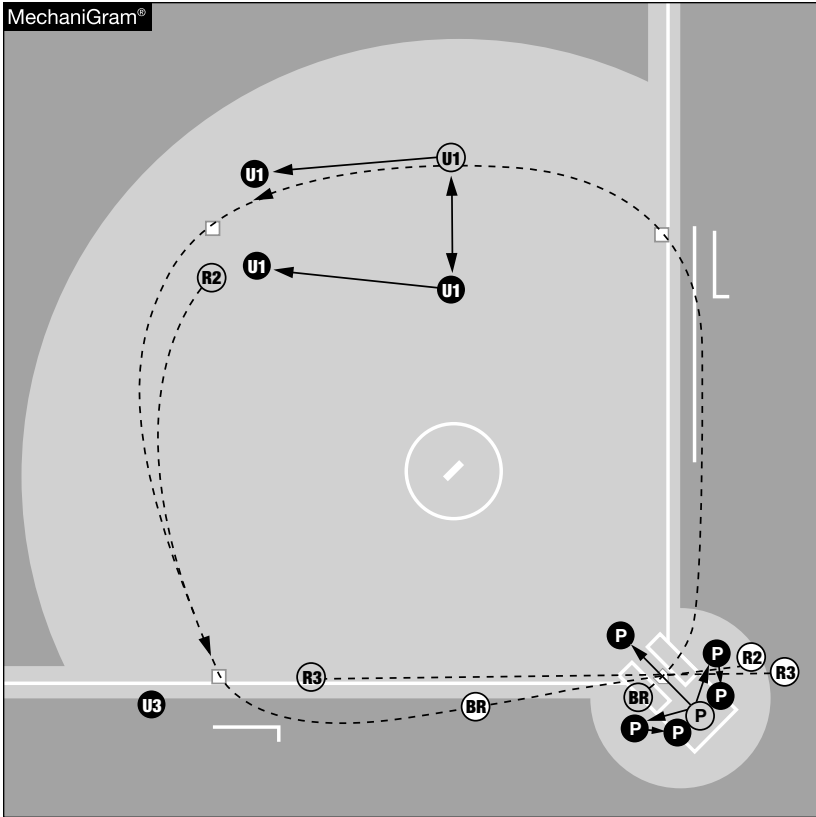

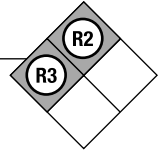

- P:**
- Stay in foul territory or straddle the base line at home plate.
 - After signaling the home run, move to an infield position in front of home plate and make all calls at home plate.
 - After the BR touches home plate, give a ball to the pitcher, catcher or closest infielder.
- U1:**
- Watch the BR touch first and second base.
 - As the BR continues on to home plate, move briskly toward your next starting position.
- U3:**
- Watch all runners touch third base.





Runners on Second and Third

U1 Chases - Ball is Caught

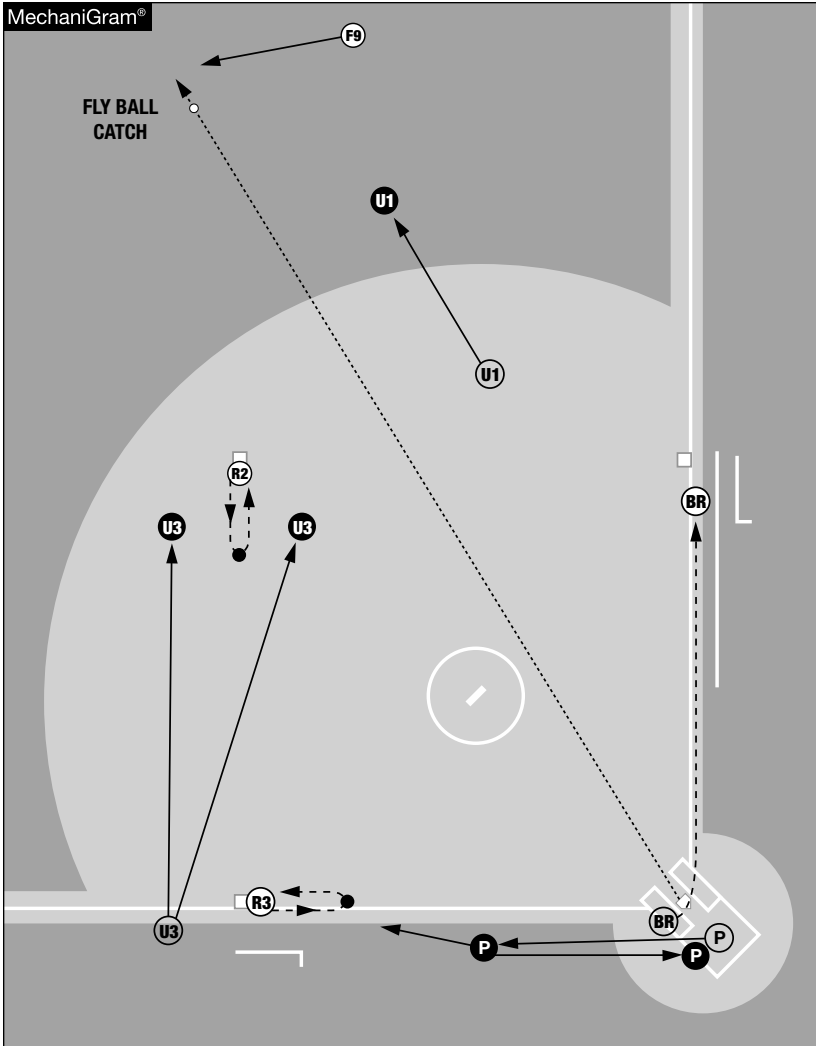

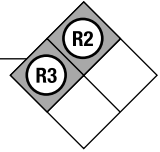

- P:**
- Move towards the holding area between home plate and third base to align yourself with the ball and R3 to see the tag up.
 - After the catch, read the throw from the outfield and commit to any play on R3 at third base and/or home plate or on R2 at third base.
- U3:**
- Move to align yourself with the ball and R2 to watch the tag up.
 - Make all calls on R2 at second base.
 - Be prepared to take R2 to third base if there is a play made on R3 at home plate.



Runners on Second and Third

U1 Chases - Ball is Not Caught

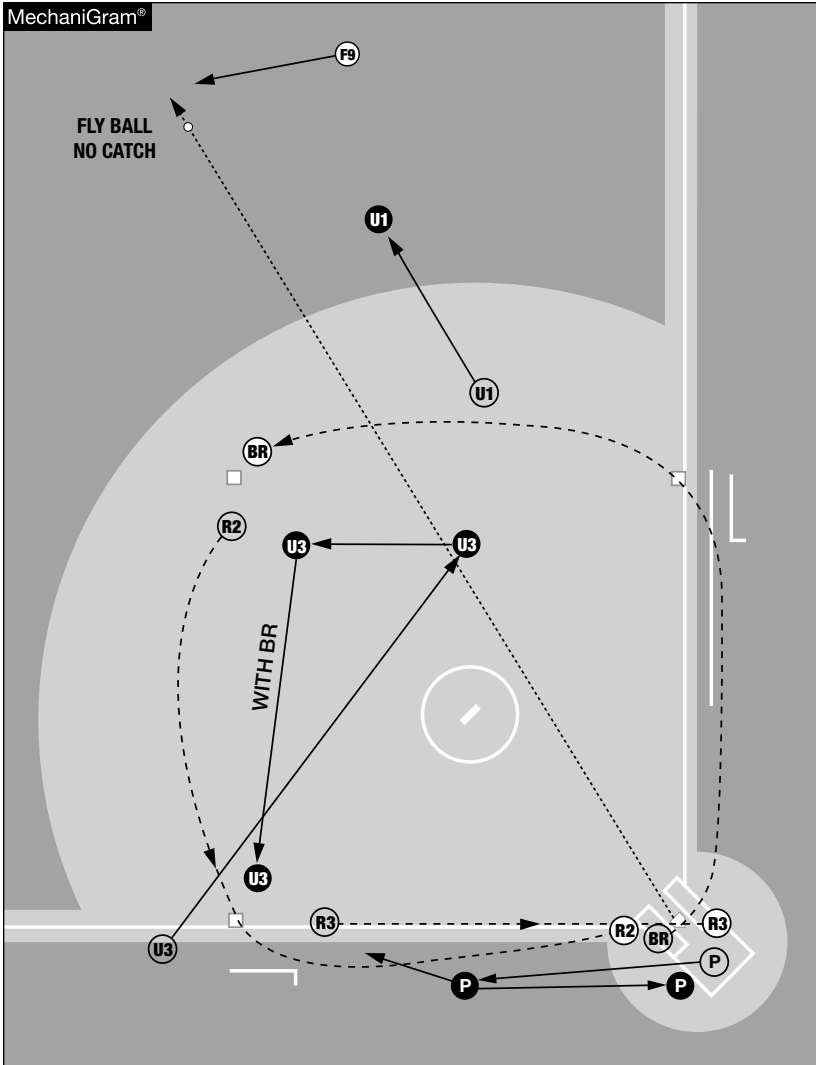

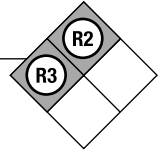

- P:**
- Move to the holding area in foul territory between home plate and third base.
 - Make all calls on R3 and R2 at third base.
 - Make all calls at home plate.
- U3:**
- Move across the infield.
 - Make all calls at first and second base.
 - Make all calls on the BR at third base.



Runners on Second and Third

U1 Chases - Home Run (Out-of-the-Park)

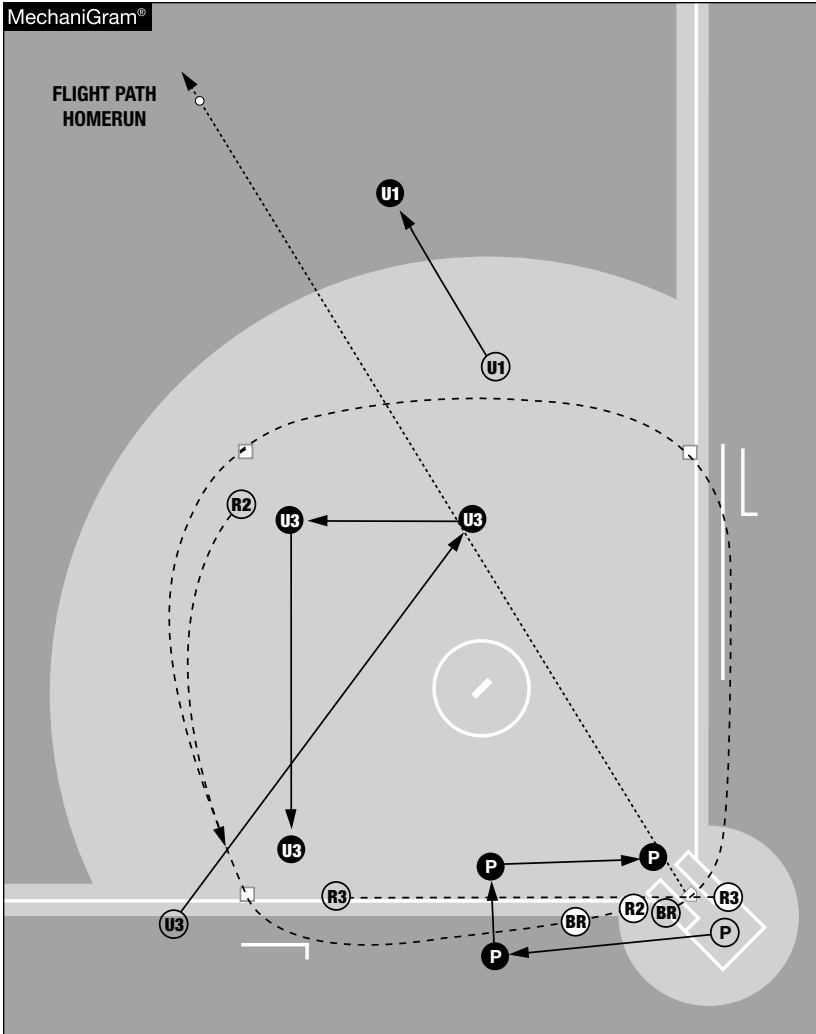

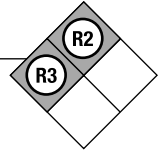

- P:**
- Move to the holding area in foul territory between home plate and third base.
 - After the home run signal, move to an infield position between home plate and third base, while watching R3 touch home plate and R2 touch third base.
 - Move to position in front of home plate with R2.
 - Make all calls at home plate.
 - After the BR touches home plate, give a ball to the pitcher, catcher or closest infielder.
- U3:**
- Move across the infield.
 - Watch the BR touch first base.
 - Move along with the BR on the inside of the diamond.
 - Watch the BR touch second and third base.



Runners on Second and Third

U3 Chases - Ball is Caught

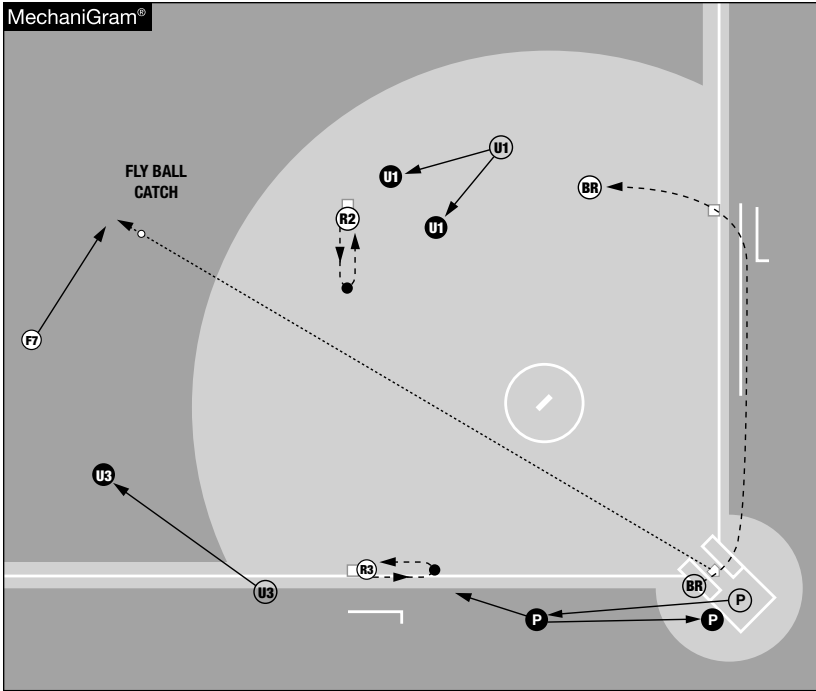

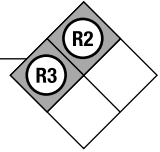

- P:**
- Move towards the holding area between home plate and third base to align yourself with the ball and R3 to watch the tag up.
 - After the catch, read the throw from the outfield and make all calls on R3 at third base and/or home plate or on R2 at third base.
- U1:**
- Move to align yourself with the ball and R2 to watch the tag up.
 - Make all calls on R2 at second base.
 - Be prepared to take R2 to third base if there is a play made on R3 at home plate.



Runners on Second and Third

U3 Chases - Ball is Not Caught

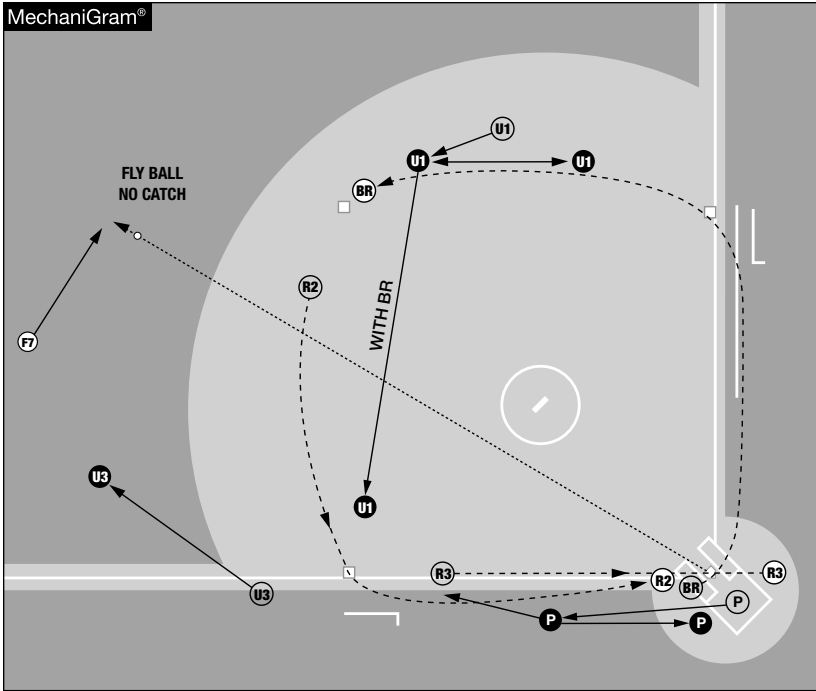

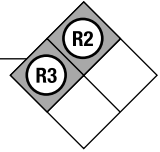

- P:**
- Move to the holding area in foul territory between home plate and third base.
 - Make all calls on R3 and R2 at third base.
 - Make all calls at home plate.
- U1:**
- Make all calls at first and second base.
 - As the BR approaches second base with the ball still in the outfield, move inside the diamond behind the BR.
 - Make all calls on the BR at third base.



Runners on Second and Third

U3 Chases - Home Run (Out-of-the-Park)

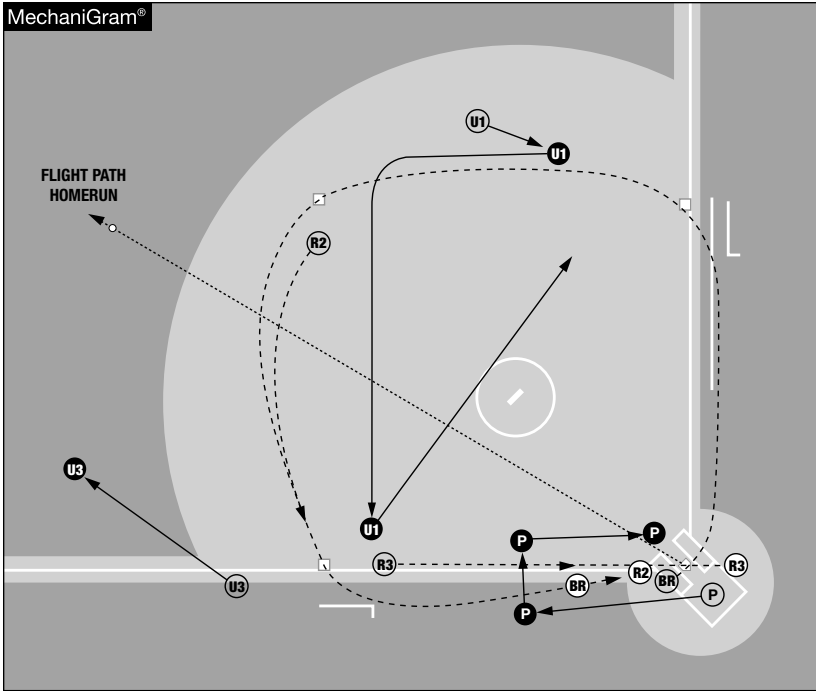

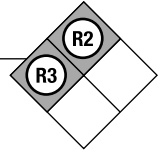

- P:**
- Move to the holding area in foul territory between home plate and third base.
 - After the home run signal, move to an infield position between home plate and third base, while watching R3 touch home plate and R2 touch third base.
 - Move to the front of home plate with R2.
 - Make all calls at home plate.
 - After the BR touches home plate, give a ball to the pitcher, catcher or closest infielder.
- U1:**
- Move toward first base, staying outside the diamond and watch the BR touch first base.
 - As the BR is approaching second base, move inside the diamond behind the BR, watching the BR touch second and third base.
 - While watching the BR continue to home plate, jog diagonally across the field heading to the next starting position.



Bases Loaded “Counter-Rotated” Starting Position

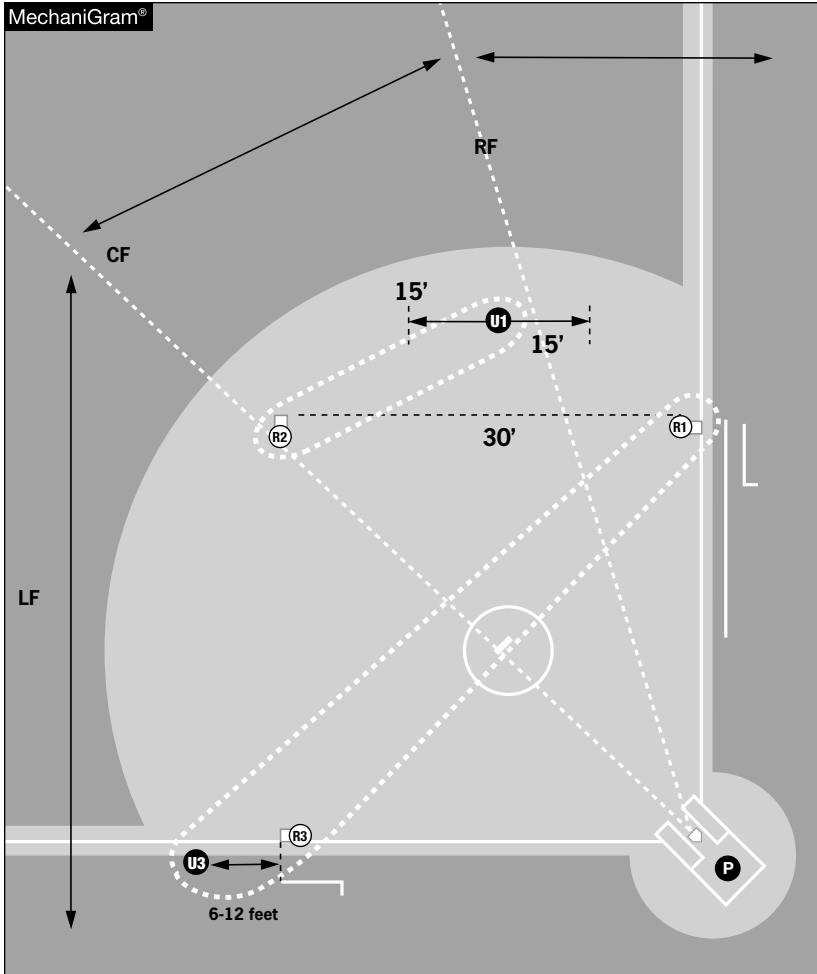

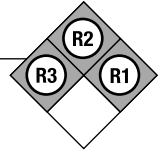

- P: Checked Swing – U3.**
Fly Ball Coverage Area – Right fielder to the right field dead ball line. When no umpire chases, all fly balls.
Tag Up Responsibilities – R3 when U3 or U1 chase.
- U1: Before the pitch –** Umpire option to come to set prior to the pitch, remain standing during the pitch, or take a step with the pitch between 15 feet from second base and the 15 feet from first base.
On the pitch – Responsible for watching R2 for leaving the base before the pitch is released.
Checked Swing – None.
Fly Ball Coverage Area – The wedge from the center fielder to right fielder. U1 has the right of first refusal on balls hit to the center fielder.
Tag Up Responsibilities – R1 on a fly ball from the center fielder to the right field dead ball line when no umpire chases. R1 and R2 on a fly ball from the center fielder to the left field dead ball line when no umpire chases or U3 chases.
- U3: Before the pitch –** Start in a set position, slightly angled towards the infield (opposite baseline between home and first base), completely in foul territory, within four feet of the line, with a clear view of the check swing, 6-12 feet beyond third base.
On the pitch – Responsible for watching R1 and R3 for leaving the base before the pitch is released.
Checked Swing – All batters.
Fly Ball Coverage Area – Center fielder to the left field dead ball line.
Tag Up Responsibilities – R3 on a fly ball hit from the center fielder to the left field dead ball line when no umpire chases. R3 and R2 on a fly ball hit from the center fielder to the right field dead ball line when no umpire chases. R2 and R1 when U1 chases.

Bases Loaded

Bases Loaded - Working Between Pitches (WBP) - Pickoff -Steal

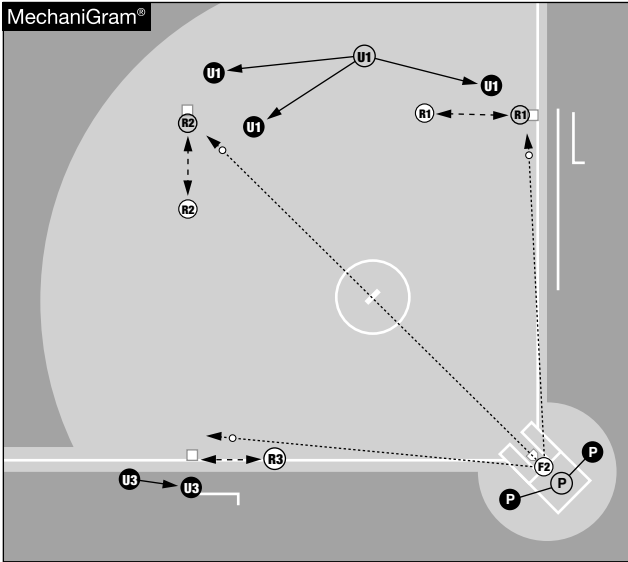

Pickoff Attempt at Third, Second or First

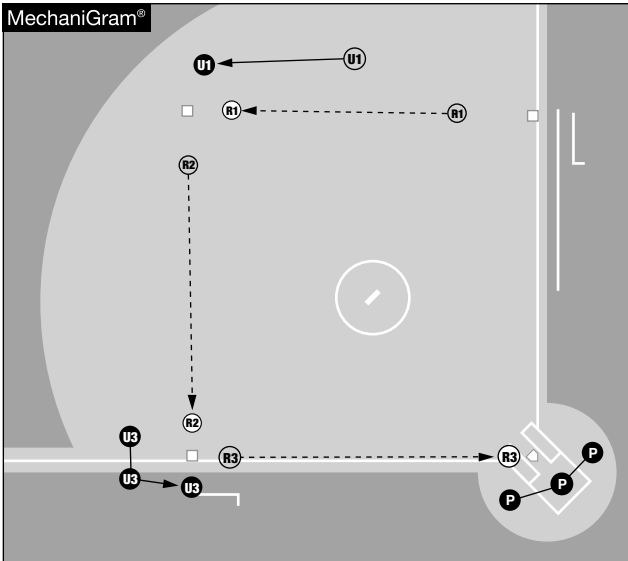

Steal - All Bases

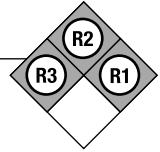

- P: WBP** – Complete the verbal and/or signal. Reset out of stance when the pitch is over. Remain alert to the batter’s actions and the catcher for any play.
Pickoff – When the pitch is over, watch the catcher’s attempt to throw the ball to any base. Look for batter interference. After the throw is released, step out from home plate, clearing the catcher and batter to watch the play.
Steal – When the pitch is over, read the play as it develops and adjust positioning as necessary to watch the applied tag or any play at home plate on any runner. Watch R3 approach and touch home plate. When a steal results from a passed ball, remain in the plate area, avoiding any throwing lanes. Keep tracking the ball and make any call on the ball (blocked ball, interference, enters dead ball area, etc.).
- U1: WBP** – Move out of the set position, move forward a few steps and watch for a possible play or obstruction at both bases. Return to a starting position once the ball is in the pitcher’s circle with the pitcher and all runners have returned to their bases.
Pickoff – Move out of the set position, move to a primary position, read the play as it develops and adjust positioning as necessary to watch the applied tag or any play at either base.
Steal – Move out of the set position and move as needed to watch any play at third base or home plate. When the throw comes to second base, move to a primary position, read the play as it develops and adjust positioning as necessary to watch the applied tag. When there is no throw, watch R1 approach, touch or round second base.
- U3: WBP** – Stay in a set position and watch for a possible play or obstruction at third base. Return to a starting position once the ball is in the pitcher’s circle with the pitcher and all runners have returned to their bases.
Pickoff – Move out of the set position, read the play as it develops and adjust positioning as necessary to watch the applied tag or any play at third base.
Steal – For R3, move out of the set position and move as needed to watch any play at home plate. For R2 or R1, adjust positioning for a tag play as it develops at third base and make the call.



Bases Loaded

Hit to the Infield

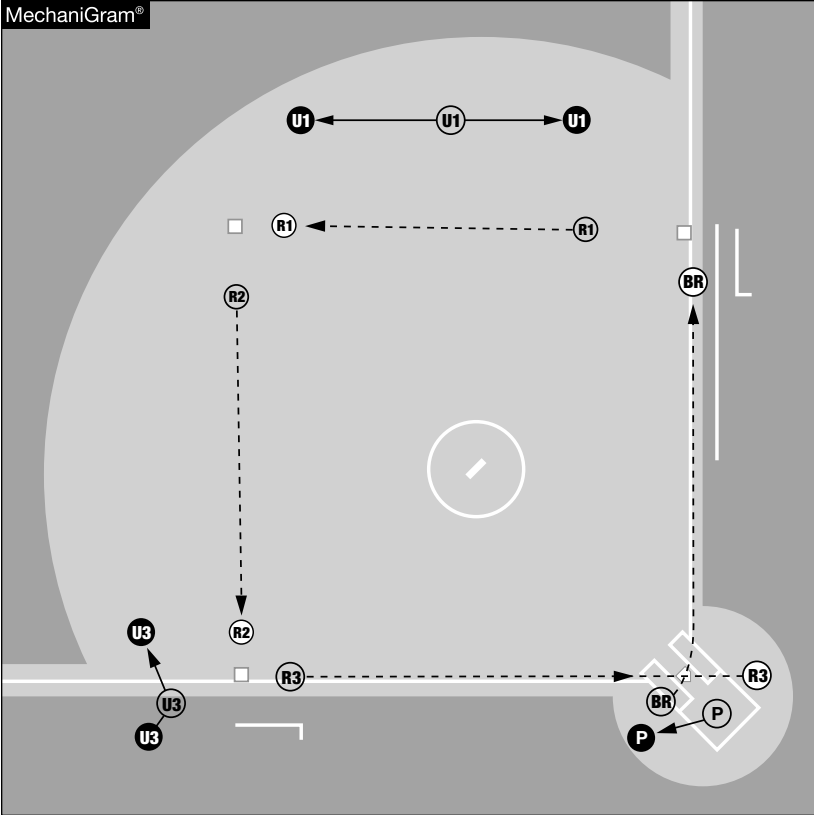

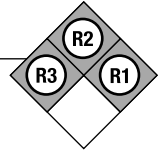

- P:**
- On a throw to first base, move to a first base line extended position.
 - When there is no throw to first base, move to the point of plate holding position.
 - Make all calls at home plate.
- U1:**
- Make all calls at first and second base.
 - When the initial throw is at second base, commit to a primary position for a force play at second base.
 - When a double play is attempted, open up to watch the force play at second base. Immediately turn with the throw to first base, close the distance, and be set to make the call at first base.
 - When the initial throw is at first base, commit to a primary position for a force play at first base. Make the call and quickly glance at second base for a possible tag play on R1.
 - When the initial play is on R3 at home plate or R2 at third base, stay at a midpoint position, then commit to the second throw in the infield to first or second base.
- U3:**
- Make all calls at third base.





Bases Loaded

Foul Fly Ball to the Infield Area

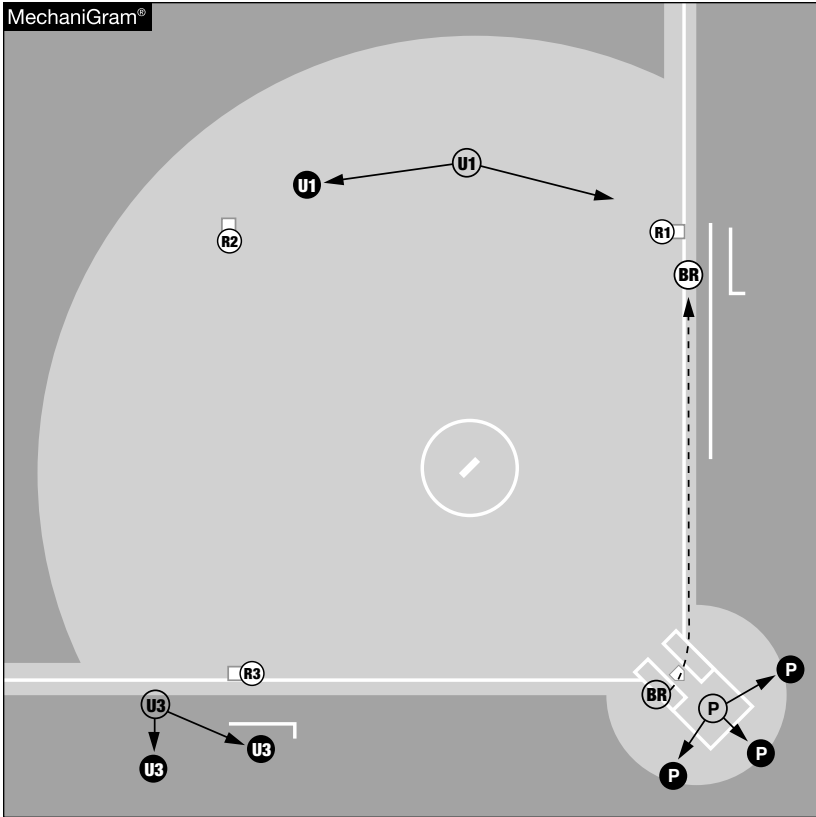

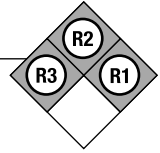

- P:**
- Once the ball is hit, read the catcher. Don't look for the ball first. Allow the catcher to take you to the ball.
 - Open pivot to the catcher's back creating room for the catcher to go to the ball.
 - Close-down the distance to the play if the infielders are diving, the ball is against the fence or near the dugout area.
 - If U3 is bracketing on the third base side, make the call on the catch/no catch if the play is facing you, the field or the dugout. Otherwise, U3 will make the call, if the play is facing them.
 - The responsibility for the catch/no catch belongs to the plate umpire, if the catch is not facing either umpire.
 - If U3 makes the catch call, be prepared to make the tag-up call on R3 or any tag play at third base. After the catch is made, quickly move back to the point of plate holding position and make any call on R3 at the plate.
- U1:**
- Seek a position to watch R2 and R1 tag up with R2 being the priority.
 - Watch R2 and R1 return and make any call at either base.
- U3:**
- Remain close to third base to watch R3 tag up.
 - Watch the play from the hit and be prepared to give help if requested.
 - Watch R3 return and make any call at third base.
 - If bracketing and the plate umpire has the catch/no catch call, focus on tag up responsibilities on R3. If you have the call, the plate umpire will focus on tag up responsibilities on R3.



Bases Loaded

No Chase - Fly Ball/Line Drive -
Ball is Caught

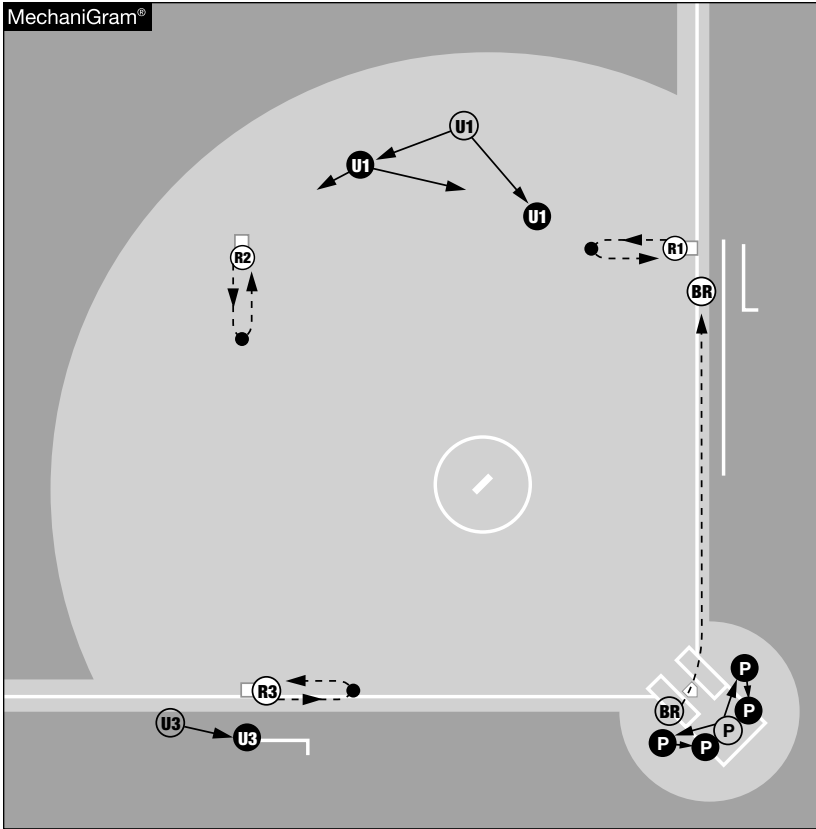

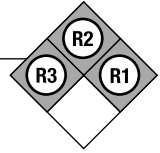

- P:**
- Stay in foul territory or straddle the base line at home plate.
 - After the catch, move to the point of plate holding position.
 - Make all calls at home plate.
- U1:**
- Move to align yourself with the ball and R2 on a fly ball hit between the center fielder and the left field dead ball line to watch the tag up.
 - After the catch, quickly turn to watch R1 tag up.
 - Move to align yourself with the ball and R1 on a fly ball hit between the center fielder and the right field dead ball line to watch the tag up.
 - Make all calls at first and second base.
- U3:**
- Move to align yourself with the ball and R3 on all fly balls and R2 on a fly ball hit between the center fielder and the right field dead ball line to watch the tag up.
 - Make all calls at third base.





Bases Loaded

No Chase - Ball is Not Caught

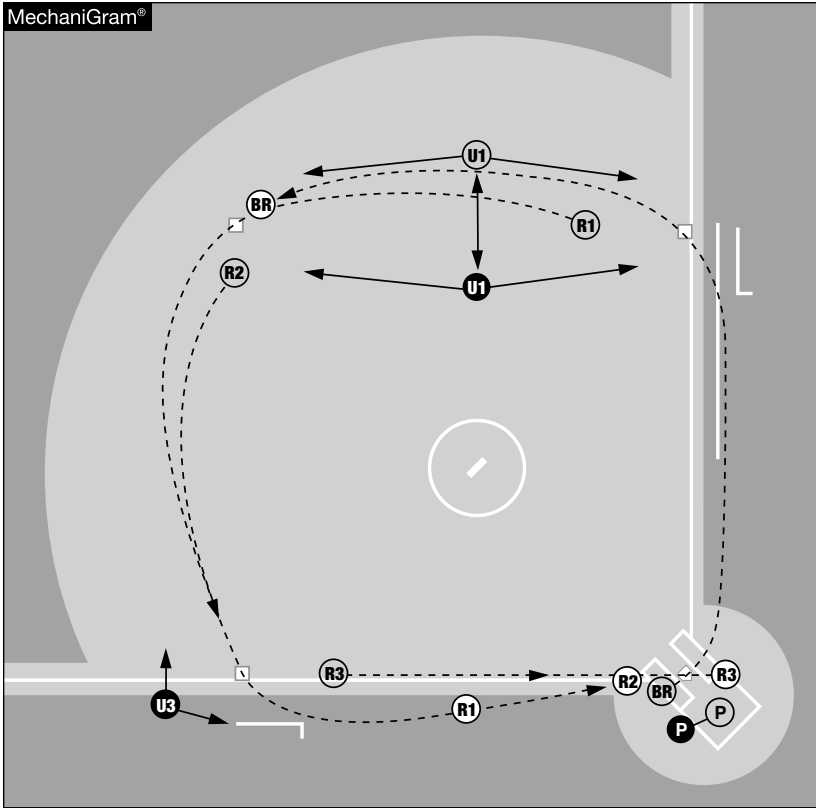

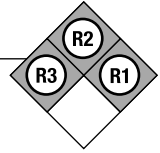

- P:**
- On a throw from right field, move to a first base line extended trail position in foul territory.
 - When there is no throw to first base, move to the point of plate holding position.
 - Make all calls at home plate.
- U1:**
- Make all calls at first and second base.
- U3:**
- Make all calls at third base.



Bases Loaded

No Chase - Home Run (Out-of-the-Park)

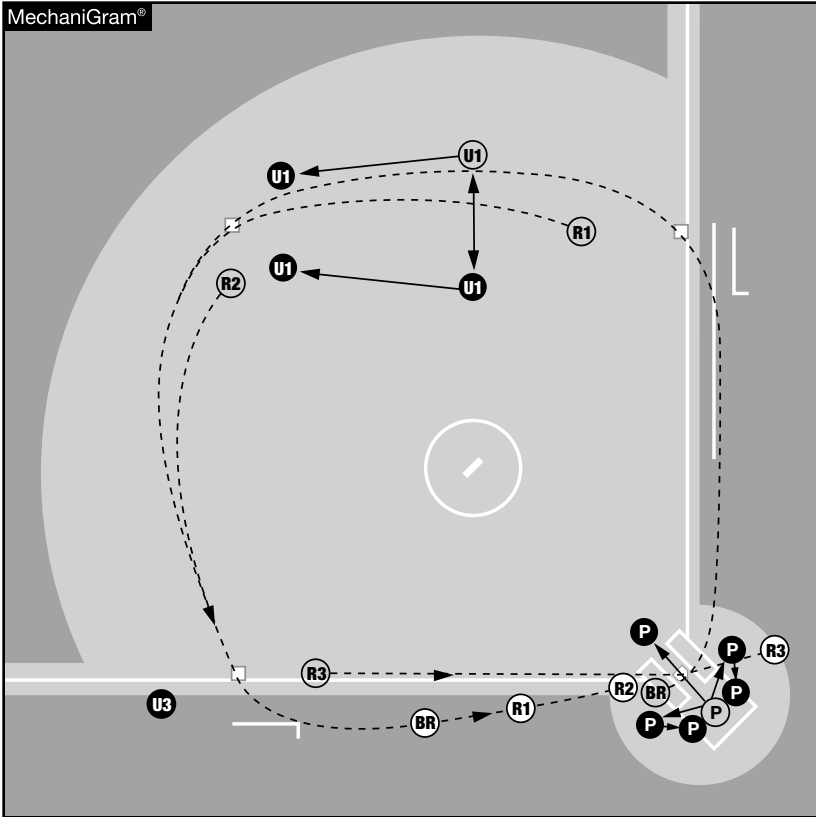

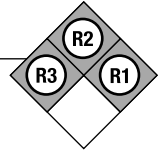

- P:**
- Stay in foul territory or straddle the base line at home plate.
 - After signaling home run, move to an infield position in front of home plate.
 - Make all calls at home plate.
 - After the BR touches home plate, give a ball to the pitcher, catcher or closest infielder.
- U1:**
- Stay outside the diamond or pivot inside (if necessary).
 - Watch R1 touch second base and the BR touch first and second base.
 - As the BR continues on to home plate, move briskly toward your next starting position.
- U3:**
- Watch all runners touch third base.



Bases Loaded

U1 Chases - Ball is Caught

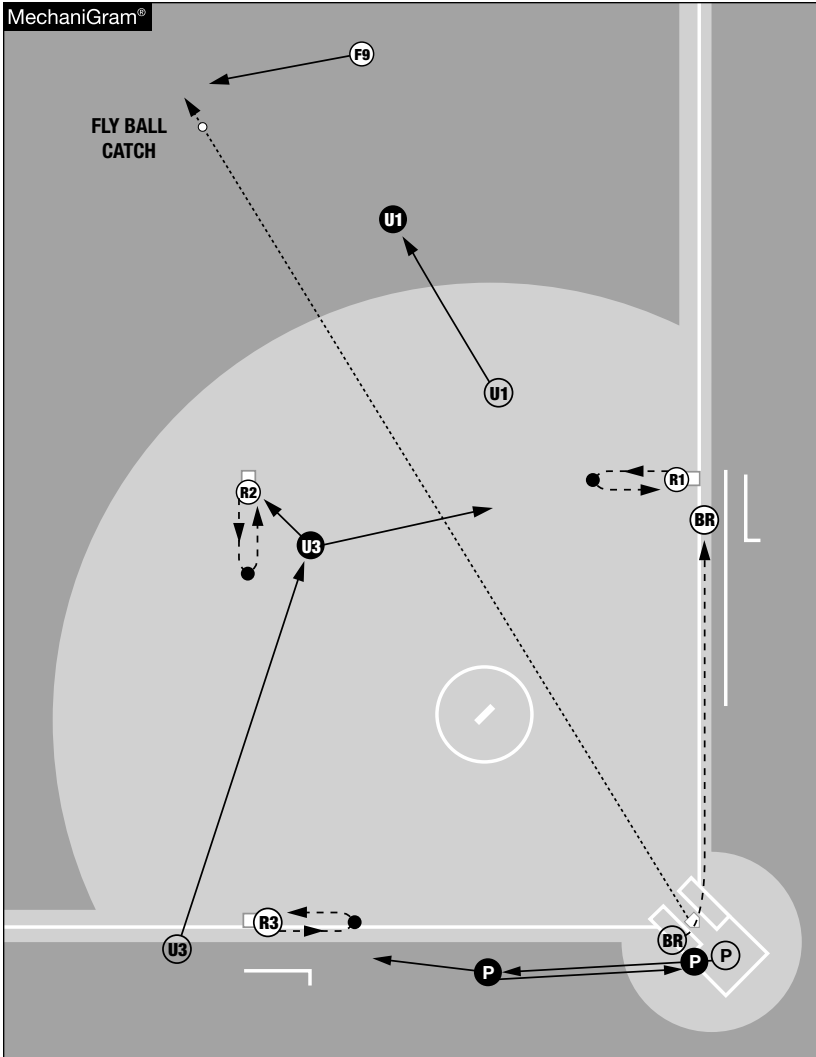

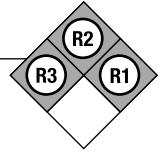

- P:**
- Move towards the holding area between home plate and third base to align yourself with the ball and R3 to see the tag up.
 - After the catch, read the initial throw from the outfield and commit to any play on R3 at third base and home plate, or on R2 at third base.
- U3:**
- Move to align yourself with the ball and R2 to watch the tag up.
 - After the catch, quickly turn to watch R1 tag up.
 - Make all calls at first and second base.
 - Be prepared to take R2 to third base if a play is made on R3 at home plate.

Bases Loaded

U1 Chases - Ball is Not Caught

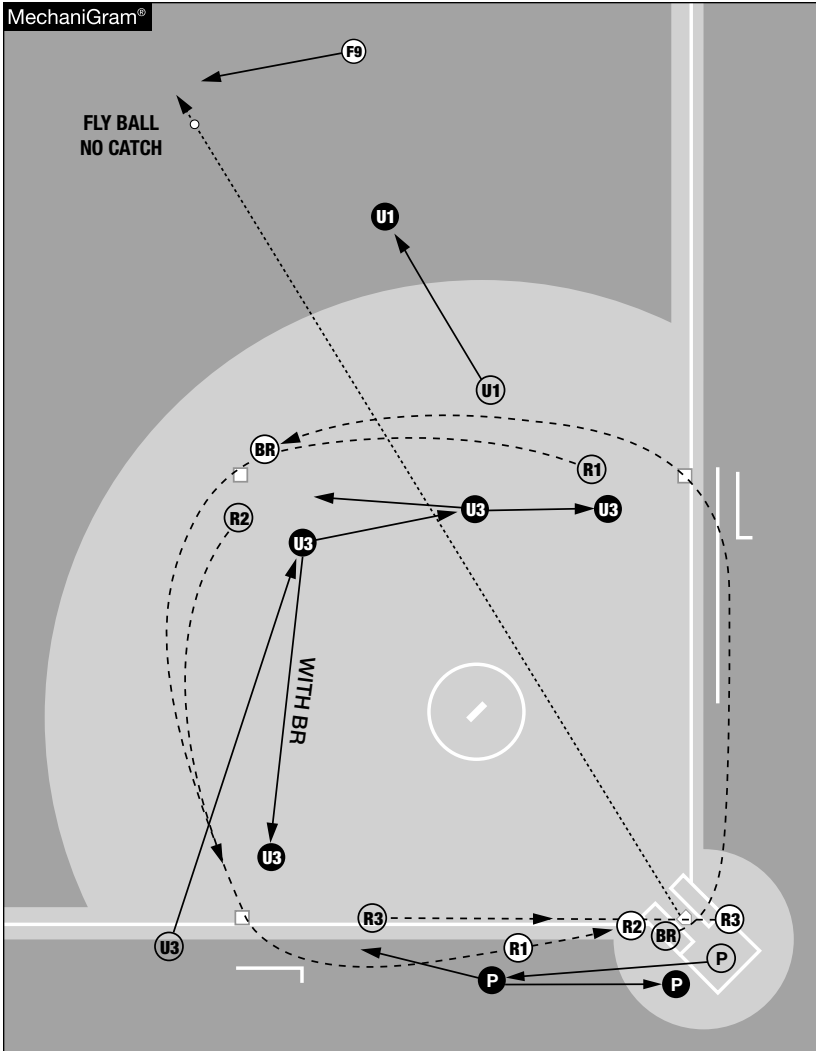

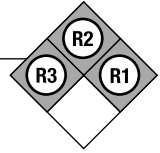

- P:**
- Move to the holding area in foul territory between home plate and third base.
 - Make all calls on R3, R2 and R1 at third base.
 - Make all calls at home plate.
- U3:**
- Move across the infield.
 - Make all calls on R1 at second base.
 - If R1 advances to third base with a play being made on R2 at home plate, make all calls on R1 at third base.
 - Make all calls on the BR at first, second and third base.



Bases Loaded

U1 Chases - Home Run (Out-of-the-Park)

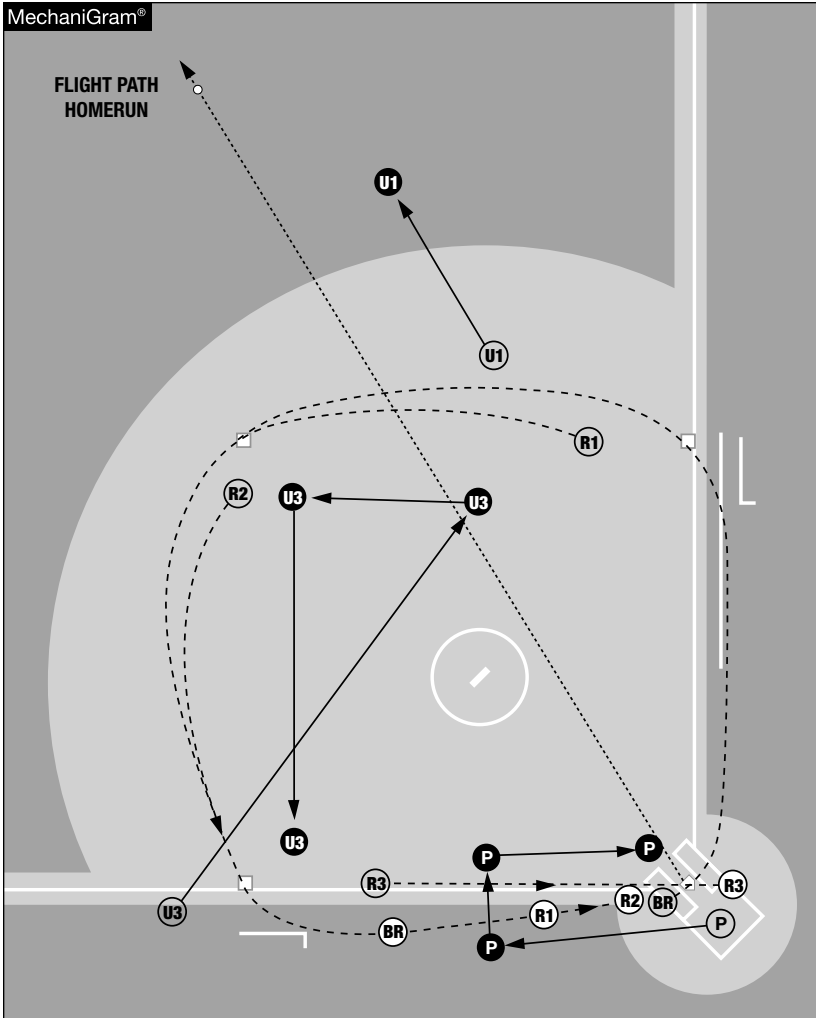

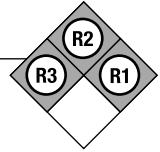

- P:**
- Move to the holding area in foul territory between home plate and third base.
 - After the home run signal, move to an infield position between home and third base while watching R3 touch home plate and R2 touch third base.
 - Move to an infield position in front of home plate, while watching R1 touch third base and make all calls at home plate.
 - After the BR touches home plate, give a ball to the pitcher, catcher or closest infielder.
- U3:**
- Move across the infield.
 - Watch R1 touch second base.
 - Watch the BR touch first base. Move along with the BR on the inside of the diamond.
 - Watch the BR touch second and third base.



Bases Loaded

U3 Chases - Ball is Caught

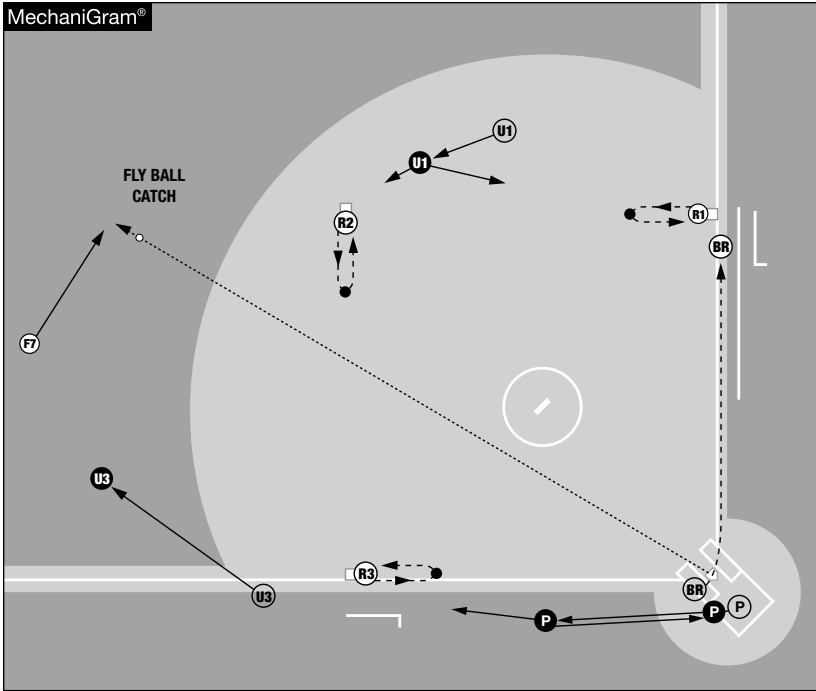

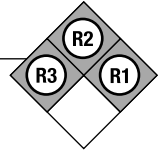

- P:**
- Move towards the holding area between home plate and third base to align yourself with the ball and R3 to watch the tag up.
 - After the catch, read the initial throw from the outfield and make all calls on R3 at third base and home plate or on R2 at third base.
- U1:**
- Move to align yourself with the ball and R2 to watch the tag up, then quickly turn to watch R1 tag up.
 - Make all calls at first and second base.
 - Be prepared to take R2 to third base if a play is made on R3 at home plate.



Bases Loaded

U3 Chases - Ball is Not Caught

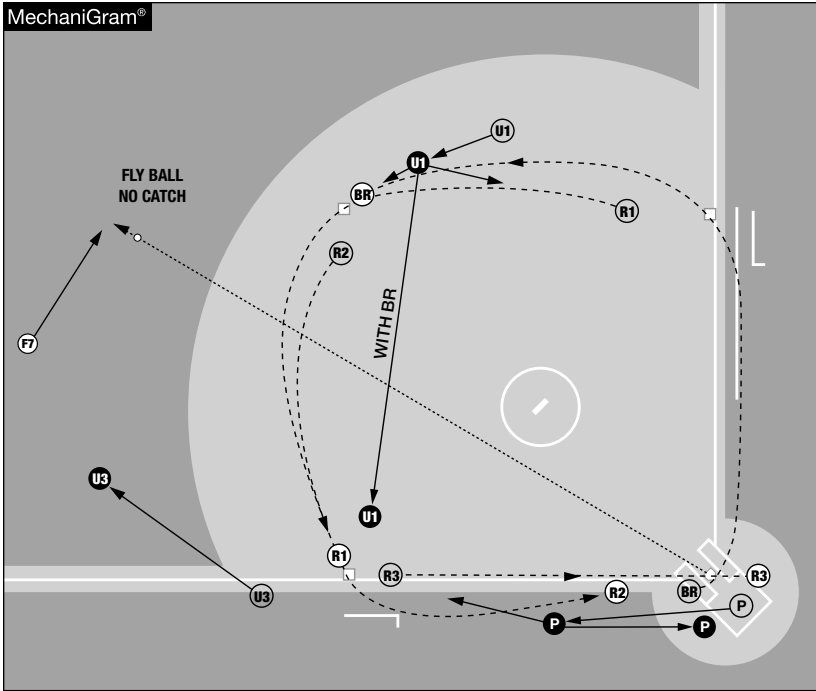

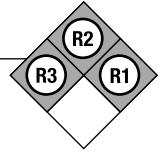

- P:**
- Move to the holding area in foul territory between home plate and third base.
 - Make all calls on R3, R2 and R1 at third base.
 - Make all calls at home plate.
- U1:**
- Make all calls on R1 at second base.
 - If R1 advances to third base with a play being made on R2 at home plate, make all calls on R1 at third base.
 - Make all calls on the BR at first and second base.
 - As the BR approaches second base with the ball still in the outfield, move inside the diamond behind the BR.
 - Make all calls on the BR at third base.



Bases Loaded

U3 Chases - Home Run (Out-of-the-Park)

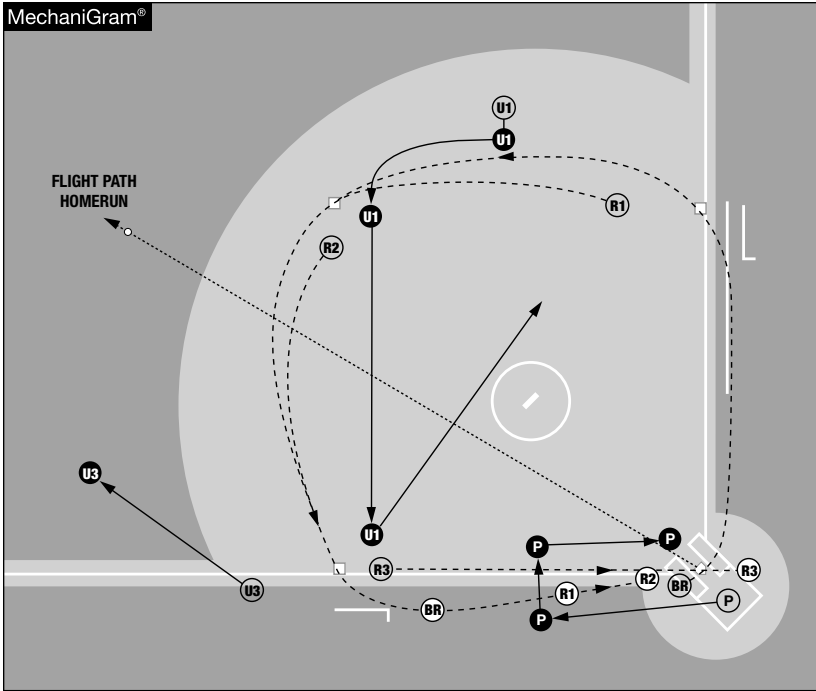

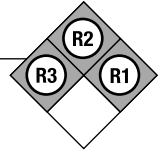

- P:**
- Move to the holding area in foul territory between home plate and third base.
 - After the home run signal, move to an infield position between home plate and third base while watching R3 touch home plate and R2 touch third base.
 - Move to an infield position in front of home plate, while watching R1 touch third base and make all calls at home plate.
 - After the BR touches home plate, give a ball to the pitcher, catcher or closest infielder.
- U1:**
- Remain outside the diamond between second and first base.
 - Watch R1 touch second base.
 - Watch the BR touch first base.
 - As the BR is approaching second base, move inside the diamond behind the BR, watching the BR touch second and third base.
 - While watching the BR continue to home plate, jog diagonally across the field heading to the next starting position.



Between Inning Positions

Standard Positions

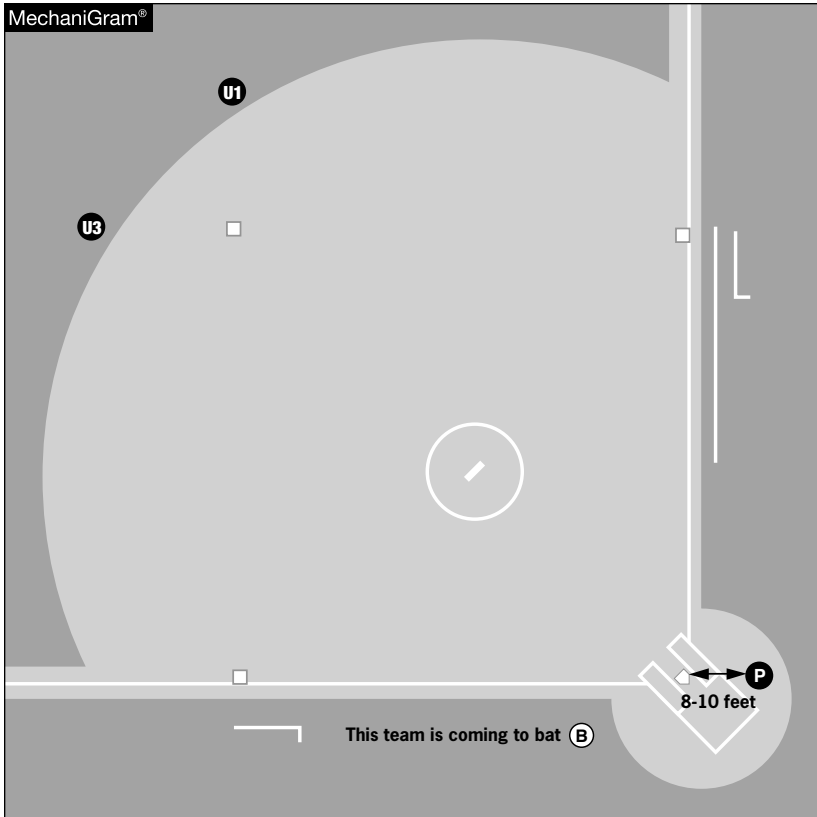

P: Face the team that is coming to bat. Stand about 8-10 feet from the line on a perpendicular line from where the foul line meets home plate.

U1: Face the plate area. Stand to third base line extended at second base on the grass.

U3: Face the plate area. Stand to first base line extended at second base on the grass.



2-PERSON MECHANICS

KEY



Plate umpire



First base umpire



Judgment point



Judgment point



Runner on first



Runner on second



Runner on third



Batter runner

Ball movement

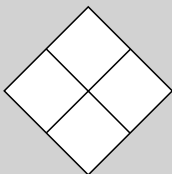

No runners on

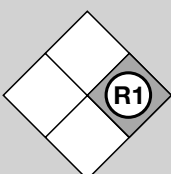

Runner on first

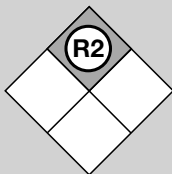

Runner on second

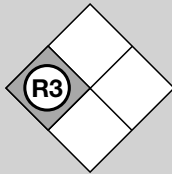

Runner on third

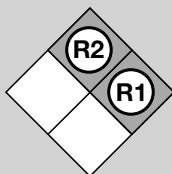

Runners on first and second

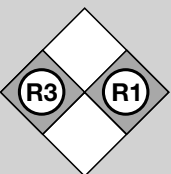

Runners on first and third

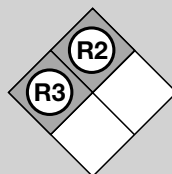

Runners on second and third

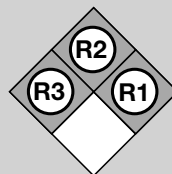

Bases Loaded

Section 10 Two-Umpire System

Although it is still being used in some areas and by some conferences, the two-umpire system is not recommended for working college softball. The three-umpire system is used for all NCAA postseason play. The purpose of this manual is to provide umpires with the information necessary to be considered for postseason selection. Proficiency of the two-umpire system is not sufficient for consideration for postseason selection. Umpires must show a mastery of the three-umpire system.

ESSENTIAL CONCEPTS

- Work ahead of the play
- Keep the elements of the play in front
- Adjust to individual play
- Efficient movement
- Prepitch preparation
- Wait — Interpret — Choose

All concepts and philosophies —

Angle • Distance • Primary Positions • Calling Positions • Secondary Positions • Parallel Movement • Efficient Movement • Professionalism • Commitment to the Play • Body Language • Signals • Crewness • Handling Conflict • Game Management • Compartment • And More — apply equally to any umpire system.



Starting Positions

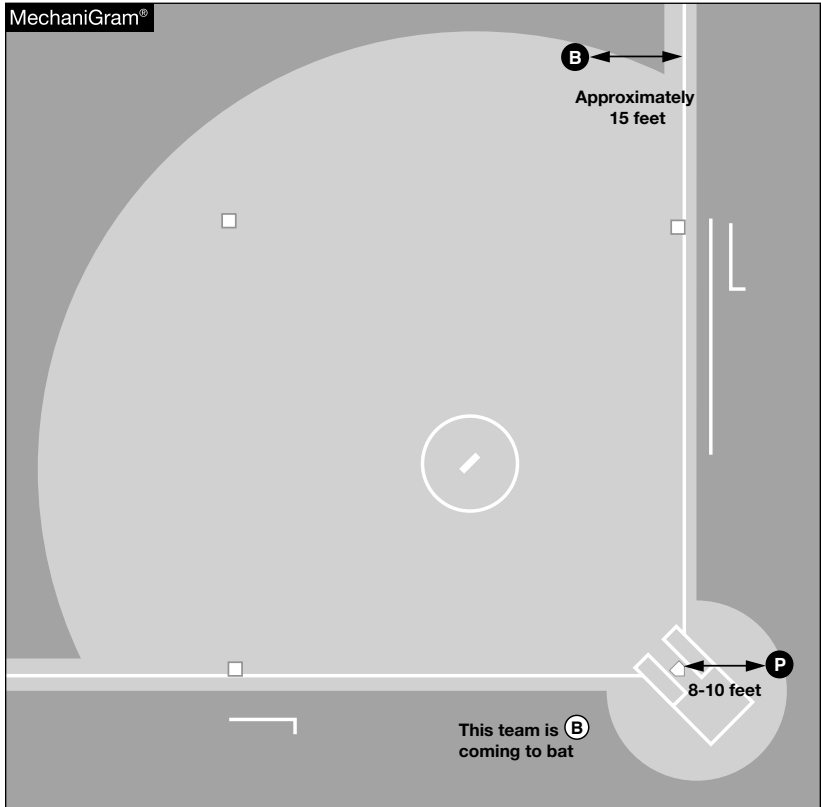

There are three starting positions for the base umpire:

A. No one on:

18 to 20 feet down the first base line, completely in foul territory, within a foot of the line, in an upright standing position and walking with the pitch, or you can start set.

B. Runner on first only:

Between first and second base, behind F4, no closer to first base than 15 feet, no farther from first than the midpoint (30 feet) between first and second base and in either a set position, standing up, or taking a step with the pitch..

C. Runners on second only, third only, first and second, first and third, second and third, or bases loaded:

Between second and third base, behind F6, no closer than 15 feet to second or third base, and in either a set position, standing, or taking a step with the pitch.

◆ **Between Inning Positions**

Plate: facing the team that is coming to bat. About 8-10 feet from the line on a perpendicular line from where the foul line meets the plate.

Base: facing the plate no more than about 15 feet off the foul line at approximately where the grass starts in front of the outfielders.

◆ **Plate Umpire Responsibilities**

- All plays at home plate.
- Seeing runners touch home plate.
- With multiple runners, all plays on the lead runner at third base except if the first play on the batted ball is by an infielder at third.
- With multiple runners, seeing the lead runner touch third base.
- All fair or foul calls except on the first base line when the base umpire starts on the line and chases.
- All catch/no-catch on fly balls unless the base umpire chases the ball.
- All plays on all bases, if the base umpire chases the ball, unless the base umpire returns.
- Seeing all runners touch all bases when the base umpire has chased.

◆ **Base Umpire Responsibilities**

- All plays at first and second base.
- Seeing runners touch first and second base.
- The first play in the infield by an infielder at first, second or third base.
- Plays on the BR at third base
- Seeing the BR touch third base.
- All steal plays.
- All pickoff attempts.
- All runners leaving before the pitch is released.



◆ Tag-Up Responsibilities

If the base umpire does NOT chase:

Plate: All tag-ups at third

Base: All tag-ups at first and second

If the base umpire DOES chase:

Plate: All tag-ups at first, second, and third

Base: No tag-ups

◆ Chasing Fly Balls

General Chase Areas from Starting Position A

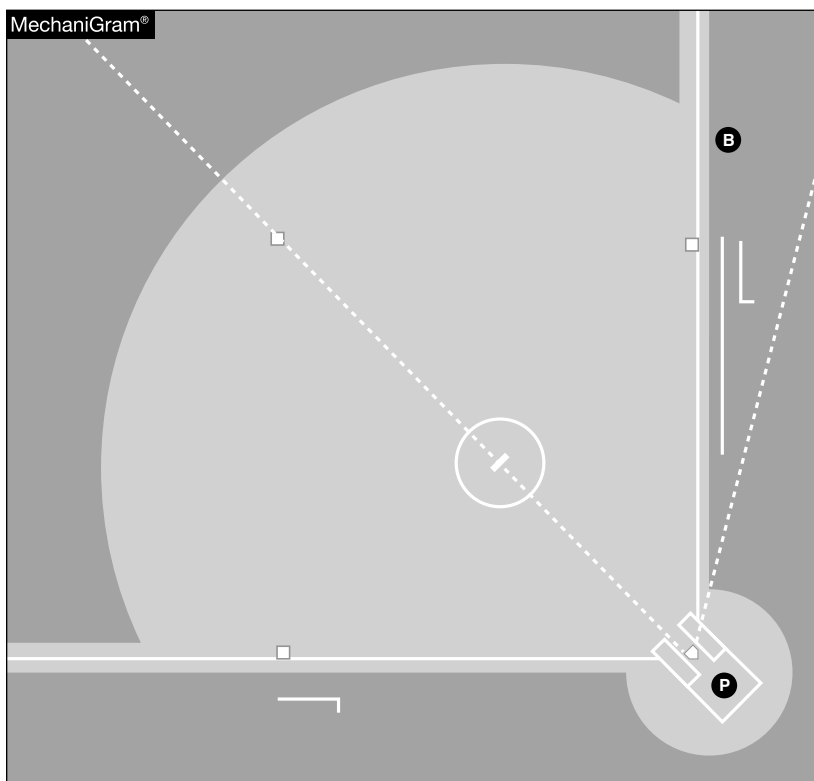

Plate umpire has from the center fielder to the left-field dead-ball line. If the base umpire does not chase, the plate umpire is responsible for all fly balls and all fair or foul decisions.

Base umpire has from the center fielder to the right-field dead-ball line.

General Chase Areas from Starting Positions B And C

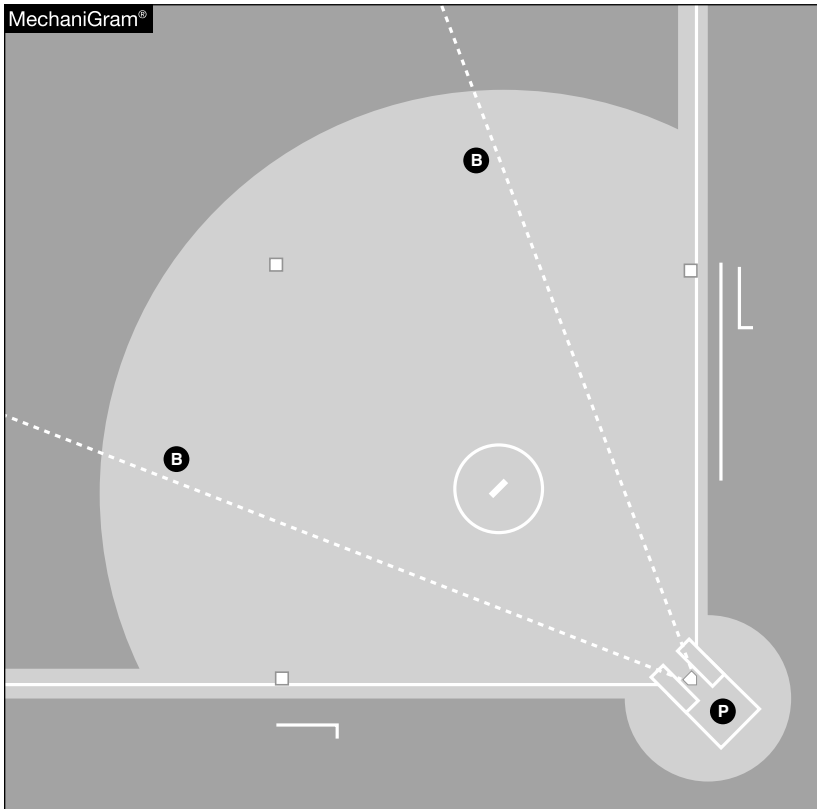

Plate umpire has from the right fielder to the right-field dead-ball line, from the left fielder to the left-field dead-ball line, and all fair or foul calls. If the base umpire does not chase, the plate umpire is responsible for all fly balls. Base umpire has from the right fielder to the left fielder (the "V").

Tip:

It is sometimes helpful to base umpires when working the two-umpire system to pretend that they are working the three-umpire system and their partner has always chased. With no runners on (position A) or with a runner on first base only (position B), pretend that the third-base umpire has chased. From position C, pretend that the first-base umpire has chased. When chasing with runners on base, you should return to the infield as outlined below.

- Never return for the initial play (for example, you chase with a runner on first and the right fielder tries to throw out the batter-runner at first)

- Most usually return for a play at second base when the plate umpire has a play at the plate.
- Return if you can during a run down when the play is moving away from you. Verbally communicate to the plate umpire that you are back.
- Let the plate umpire know where you are.
- Do not return to home plate.
- You do not have to return to the infield, nor should you always, but you must always be prepared to do so.





No Runners on Base Hit to the Infield

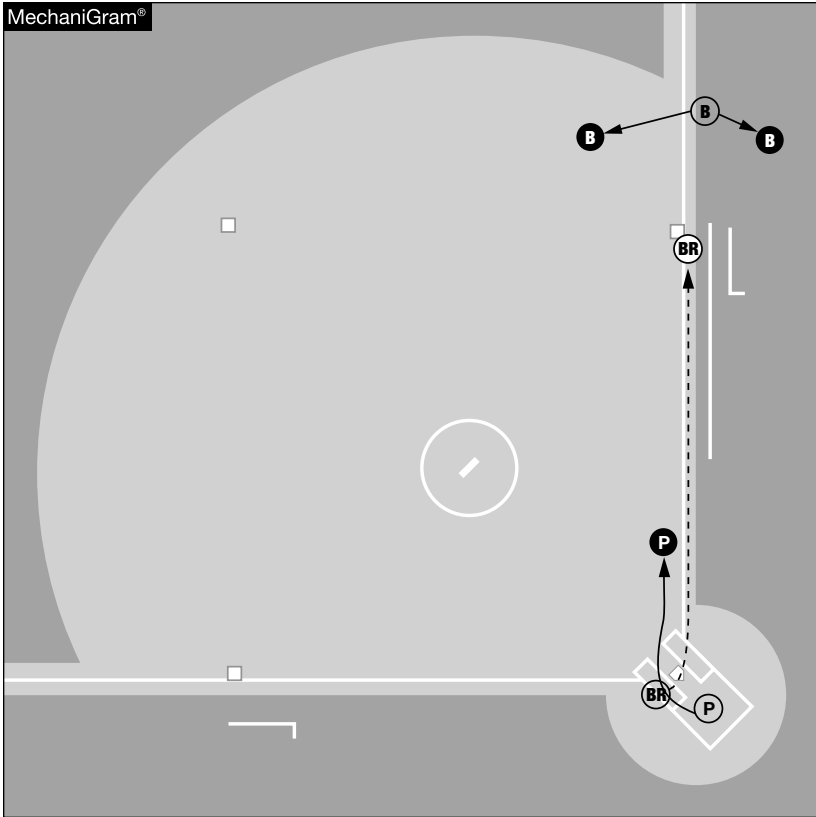

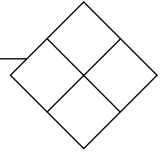

P:

- On a throw to first base, trail the batter-runner in fair territory no more than 15 feet up the line.
- When the ball is not thrown to first base, do not trail but move to the front of the circle.

B:

- Move into fair territory for a force play at first base. You may use foul territory only if necessary.
- Make all calls at first base.
- Take any play when the BR continues to second or third base.





No Runners on Base

Foul fly ball to the Infield Area

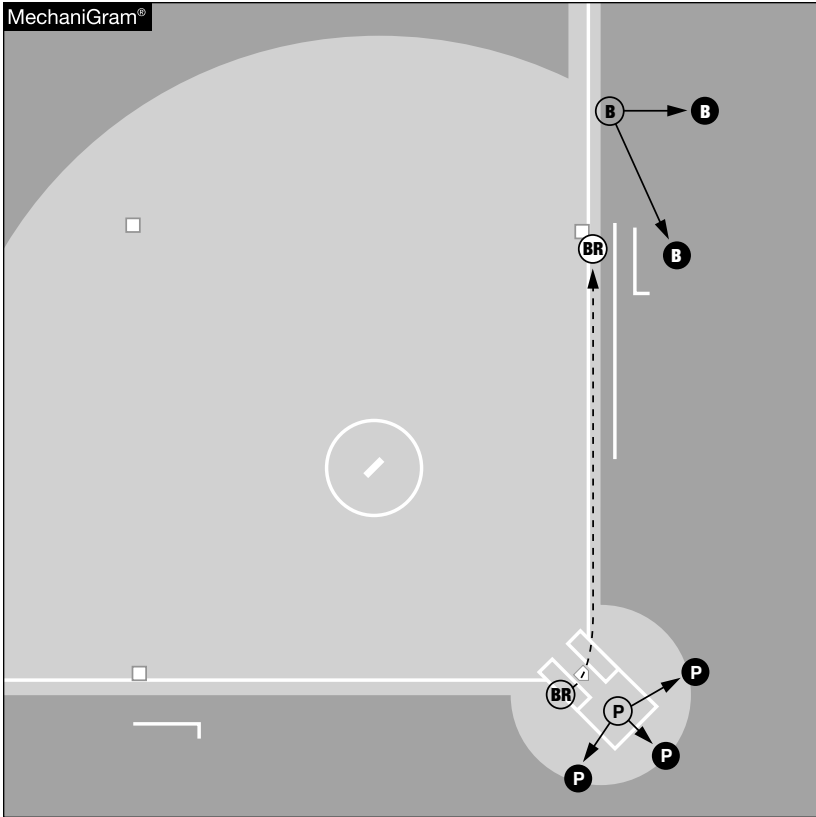

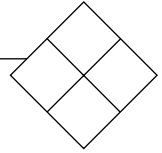

P:

- Once the ball is hit, read the catcher. Allow the catcher to take you to the ball.
- Close-down the distance to the play if the infielders are diving, the ball is up against the fence or near the dugout area.
- When a base umpire is bracketing the play, the base umpire will make the catch/no catch if the play is facing them.

B:

- When the fly ball is on the first base side, move into foul territory to bracket the play with the plate umpire.
- Close-down the distance to the play if the infielders are diving, the ball is up against the fence or near the dugout area.
- Make the call on the catch/no catch if the play is facing you. Otherwise, the plate umpire will make the call.



No Runners on Base

Fly ball/Line Drive - Ball is Caught

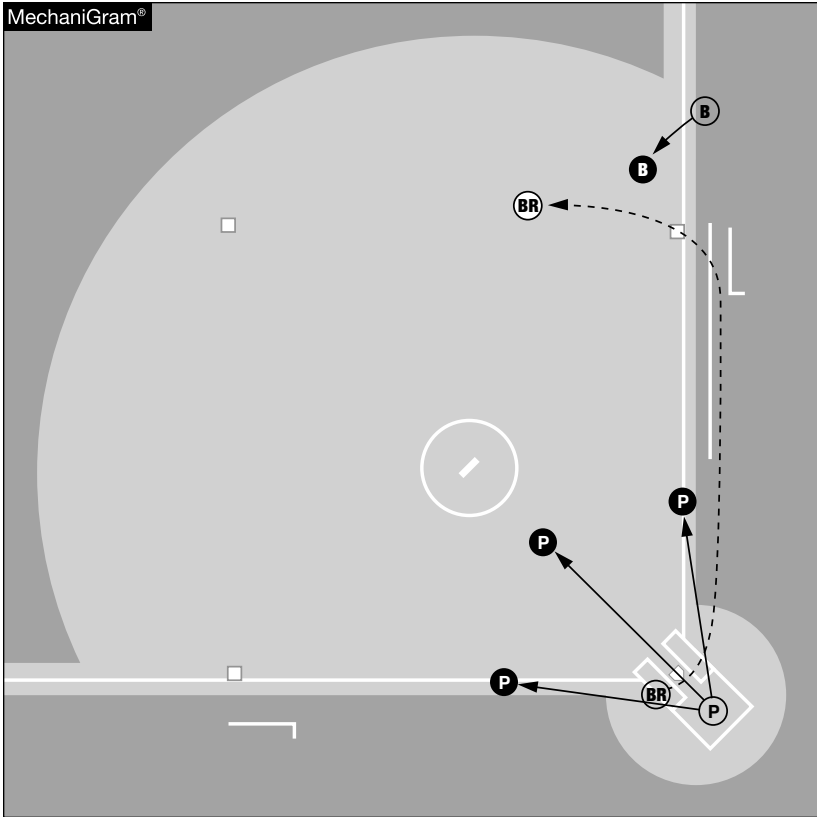

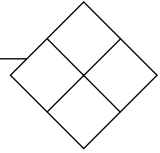

P:

- When the base umpire has chased:
 - Move all the way to a primary position for a possible force play at first base.
 - Take all plays on the BR at all bases.
- When the base umpire has not chased:
 - Move from home plate into the infield in the direction of the flight of the ball.

B:

- Move into fair territory staying outside the diamond or pivot inside the diamond, if necessary, to keep all the elements of the play in front of you as the BR rounds first base.
- Make all calls at first base.
- If the ball is not caught, be ready to take the BR to second and third base.



No Runners on Base

Hit to the Outfield

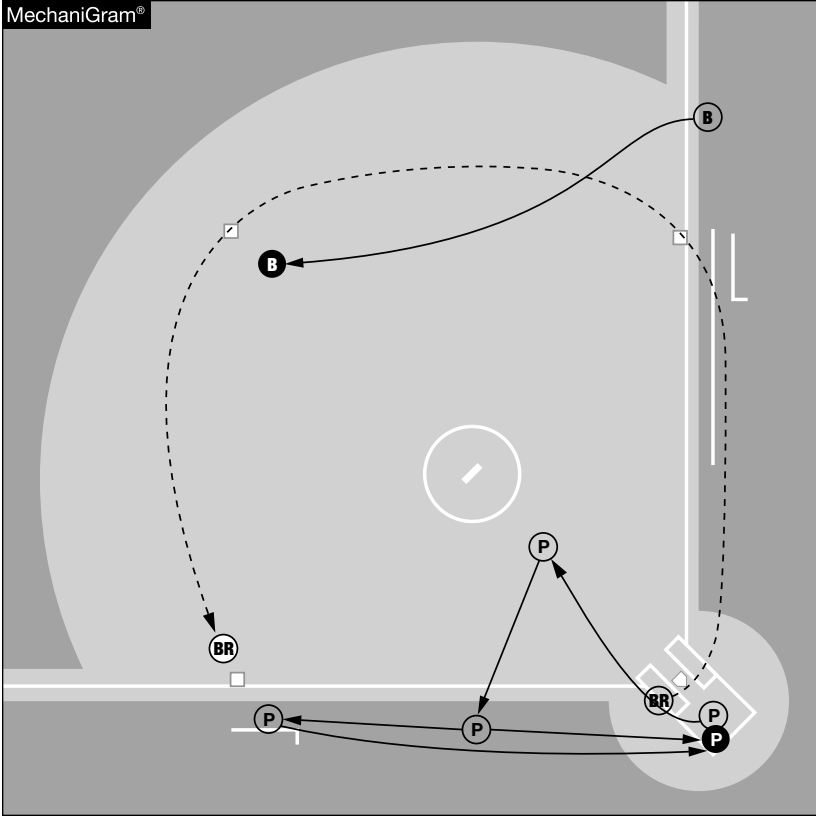

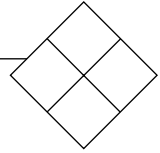

P:

- Move into the infield in the direction of the flight of the ball.
- When the ball is not caught move to the holding zone between third base and home plate.
- Make all calls at third base and home plate.

B:

- Move into fair territory staying outside the diamond or pivot inside the diamond, if necessary, to keep all the elements of the play in front of you as the BR rounds first base.
- Make all calls at first base.
- As the BR is approaching second base with the ball still in the outfield, move inside the diamond behind the BR.
- Make all calls at second base.



Runner on First

Working Between Pitches, Pickoff

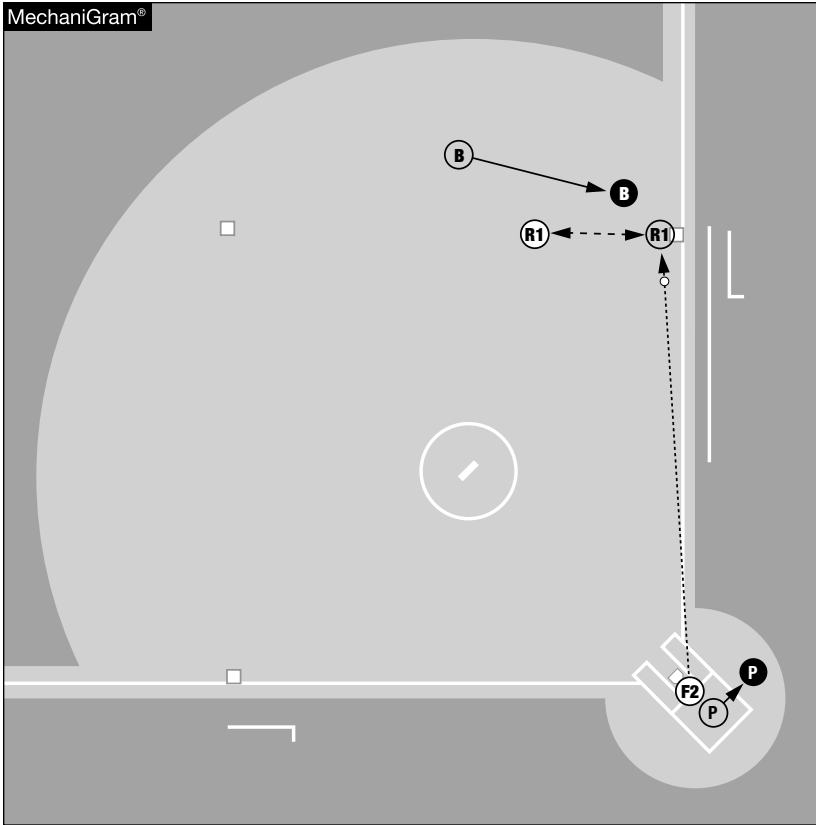

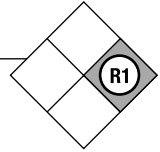

Working between pitches

P:

- Move out of stance when the pitch is over completing verbal and/or signal.
- Remain alert to the batter's actions and the catcher for any play.

B:

- Move out of the set position, move toward first base parallel to the baseline, or slightly diagonal depending on the starting depth, toward the primary position at first base.
- When the ball is in circle with pitcher and R1 has returned to first base, return to starting position.

Pickoff

P:

- When the pitch is over, watch the catcher's attempt to throw and look for batter interference.
- After the throw, step out clearing the catcher and batter to watch the play at first base.

B:

- Move out of the set position, move to as close to the primary position as possible, read the play as it develops and adjust positioning as necessary to make the call.
- Take any play at second or third base.



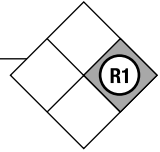

Steal

P:

- When the pitch is over, watch the catcher's attempt to throw and look for batter interference.
- After the throw is released, move up toward third base in foul territory.
- If R1 steals as a result of a passed ball, do not move any farther than the holding area between home plate and third base avoiding any throwing lanes to third base.
- Keep tracking the ball and make the call on any play on the ball (blocked, interference, dead ball).
- Make all calls at third base if the BR advances.

B:

- Move out from the set position, move to a primary position, read the play as it develops and adjust positioning as necessary to watch the applied tag or any play at second base.
- Take any subsequent play at second base.





Runner on First Hit to the Infield

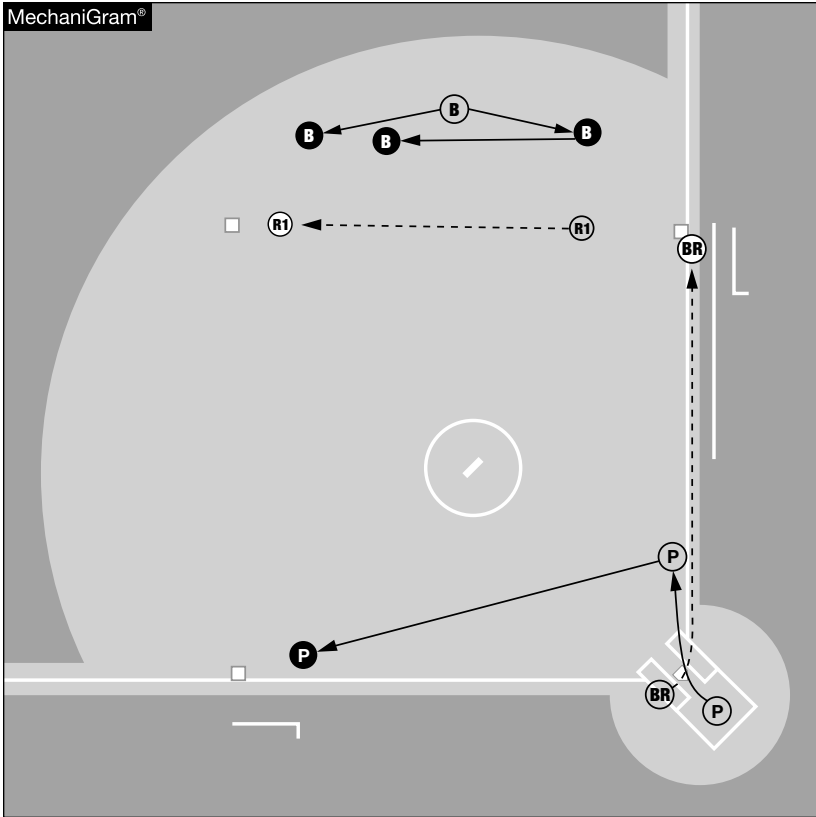

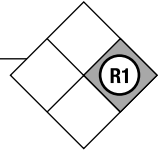

P:

- On a throw to first base, trail the batter-runner in fair territory no more than 10 feet up the line; be set to watch the play at first base.
- Do not trail if there is no throw to first base. Move to a primary position for a tag play at third base.
- Take any play on R1 at third base and home plate.

B:

- Make all calls on R1 at second base and the BR at first, second and third base.
- When the initial throw is to second base with no possibility for a double play, commit to a primary position for the force play.
- When a double play is attempted, open up to watch the force play at second base. Immediately turn with the throw to first base, close the distance, and be set to make the call at first base.
- When the initial throw is to first base, commit to a primary position for the force play.
- When the batter-runner is safe or there is no throw, watch the batter-runner approach, touch, overrun or round first base.
- After the play is finished at 1B, be ready to move toward 2B for a possible play on R1 rounding too far.



Runner on First

Fly ball/Line Drive - Ball is Caught

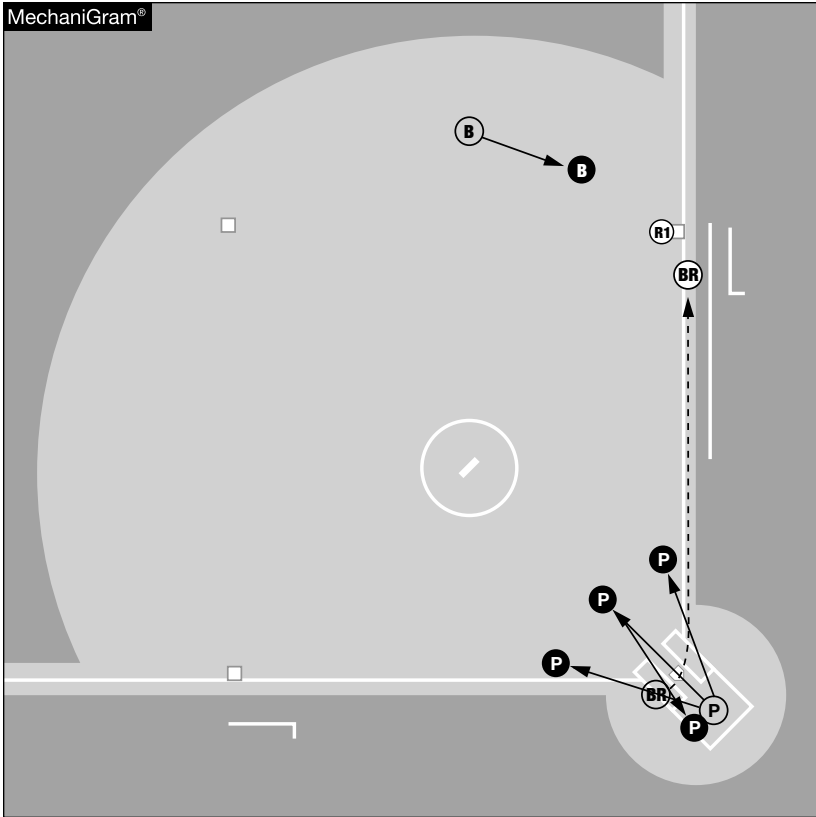

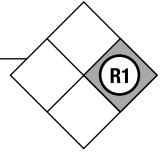

P:

- Move into the infield in the direction of the flight of the ball.

B:

- Move to get the best angle to watch R1 tag up.
- Make all calls on R1 at first, second and third base.

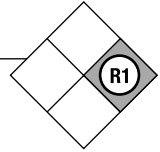

P:

- Move into the infield in the direction of the flight of the ball.
- When the ball is not caught either move to the foul holding area or all the way to third base.
- Make all calls on R1 at third base and home plate.

B:

- Stay outside the diamond or move inside.
- Make all calls at first and second base.
- Take any plays on the BR at third base.





Runner on Second

Working Between Pitches, Pickoff , Steal

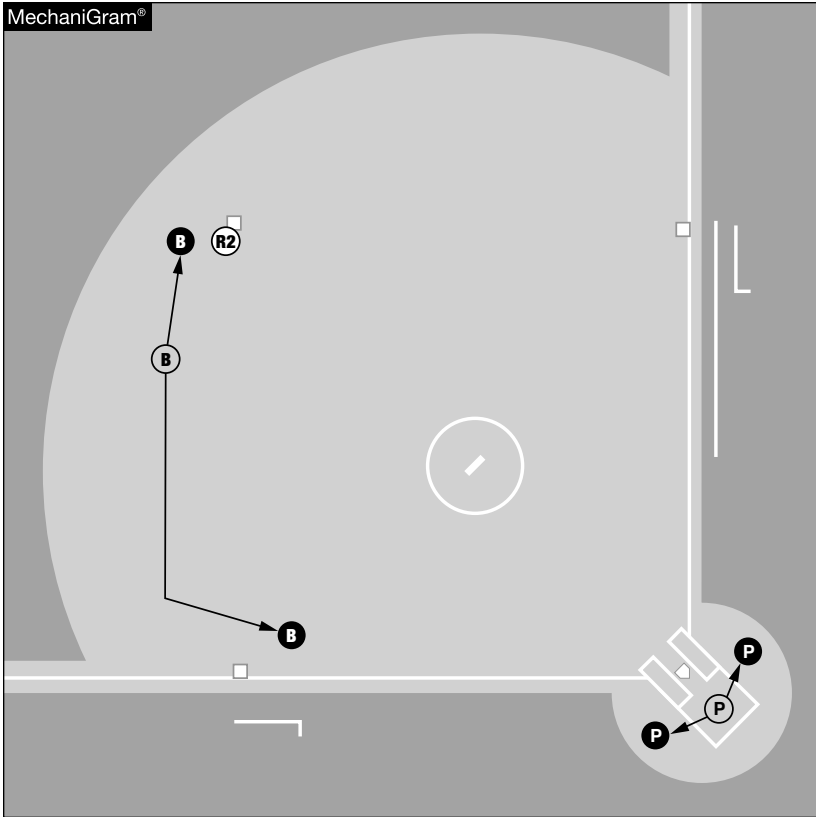

Working between pitches

P:

- Move out of stance when the pitch is over, completing verbal and/or signal.
- Remain alert to the batter's actions and the catcher for any play.

B:

- Move out of the set position, move toward second base parallel to the baseline, or slightly diagonal depending on the starting depth, toward the primary position at second base.
- Watch for a possible play or obstruction.
- When the ball is in the pitcher's circle and R2 has returned to first base, return to starting position.



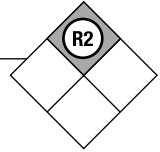

Pickoff

P:

- When the pitch is over, watch the catcher's attempt to throw and look for batter interference.
- After the throw, step out clearing the catcher and batter to watch the play at second base.

B:

- Move out of the set position, move toward second base parallel to the baseline, or slightly diagonal depending on the starting depth, toward the primary position at second base.
- Take any play on R2 at second base and third base.

Steal

P:

- When the pitch is over, watch the catcher's attempt to throw and look for batter interference.
- After the throw is released, step out to the left and watch the play at third base.
- If the pitch is a passed ball, remain in the plate area avoiding any throwing lanes to third base.
- Keep tracking the ball and make the call on any play on the ball (blocked, interference, dead ball).

B:

- Move out of the set position, move toward third base parallel to the baseline, or slightly diagonal depending on the starting depth, toward the primary position at third base.





Runner on Second Hit to the Infield

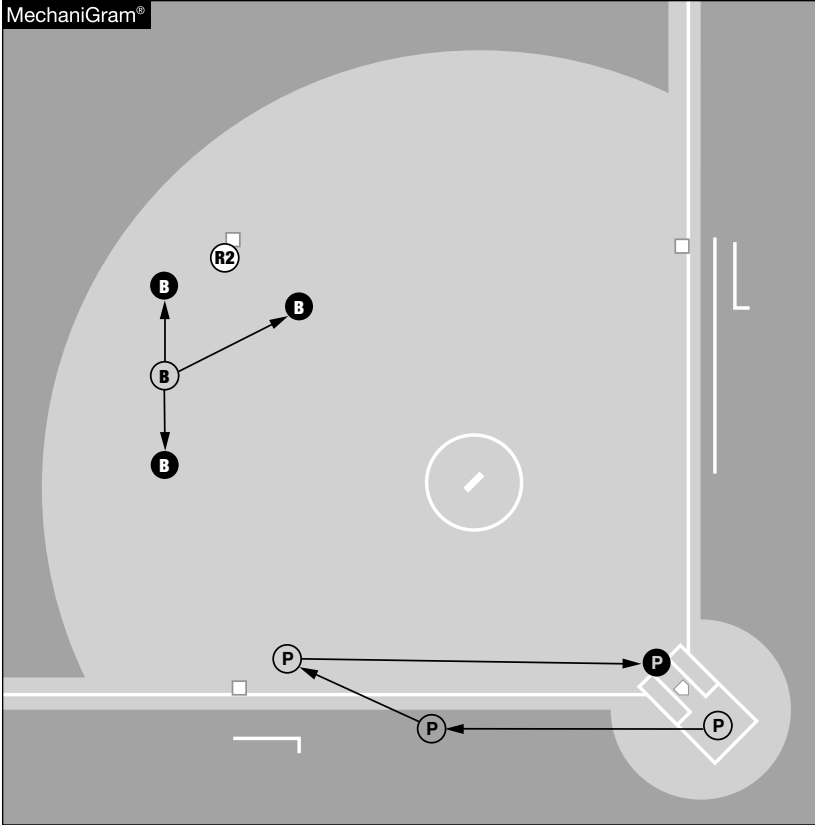

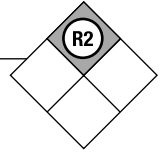

P:

- Start moving toward the holding area in foul territory between third base and home plate as you watch any play on R2 at second base or the BR at first base.
- Make any call on R2 at third base and home plate.

B:

- When the initial throw is to first base, move into the diamond as far as possible to get the best angle and distance for the force play at first base, staying out of throwing lanes.
- If the BR is out at first base, watch the play at third base.
- If the BR is safe at first base, commit toward the BR, staying out of throwing lanes.
- When the initial throw is to second or third base, move toward that base parallel to the baseline, or slightly diagonal depending on the starting depth, toward the primary position at that base.





Runner on Second

Fly ball/Line Drive - Ball is Caught

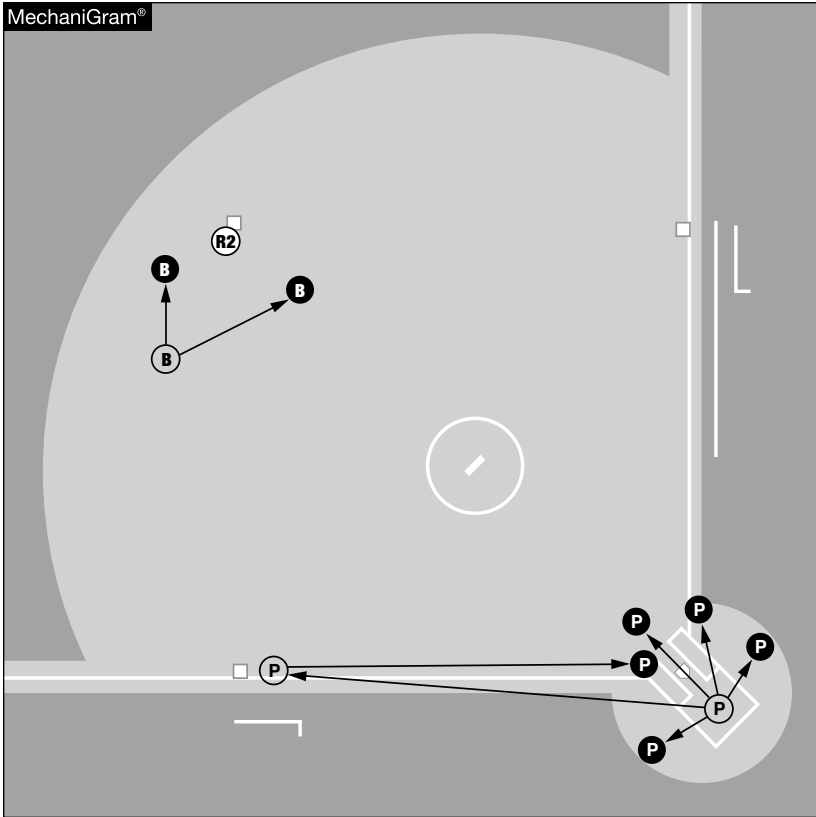

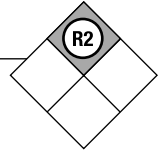

P:

- Move into the infield in the direction of the flight of the ball.
- If R2 advances to third base, commit to third base; make any call on R2 at third base and home plate.

B:

- Move to a straight line to the ball and R2 to see the tag up.
- Make all calls at second base. If the plate umpire is unable to cover third base due to the location of the fly ball be prepared to take R2 to third base.



Runner on Second Hit to the Outfield

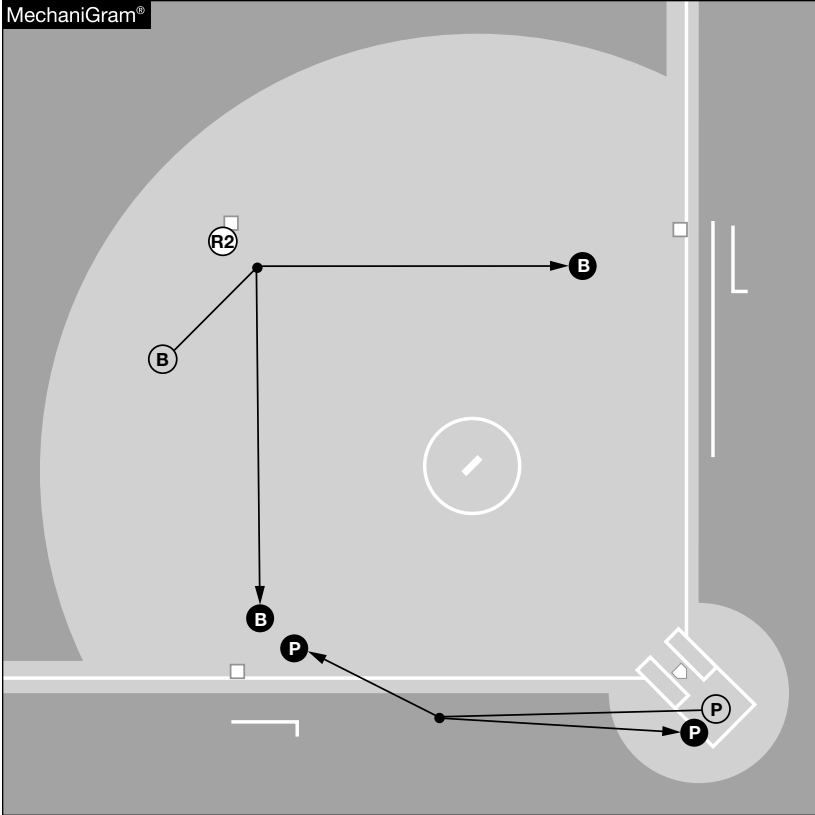

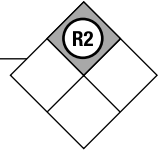

P:

- Start moving toward the holding area in foul territory between third base and home plate as you watch the play develop.
- Make all calls on R2 at third base.
- Make all calls at home plate.

B:

- Move into the diamond.
- Make all calls on the BR at first, second and third base.



Runner on Third

Working Between Pitches, Pickoff

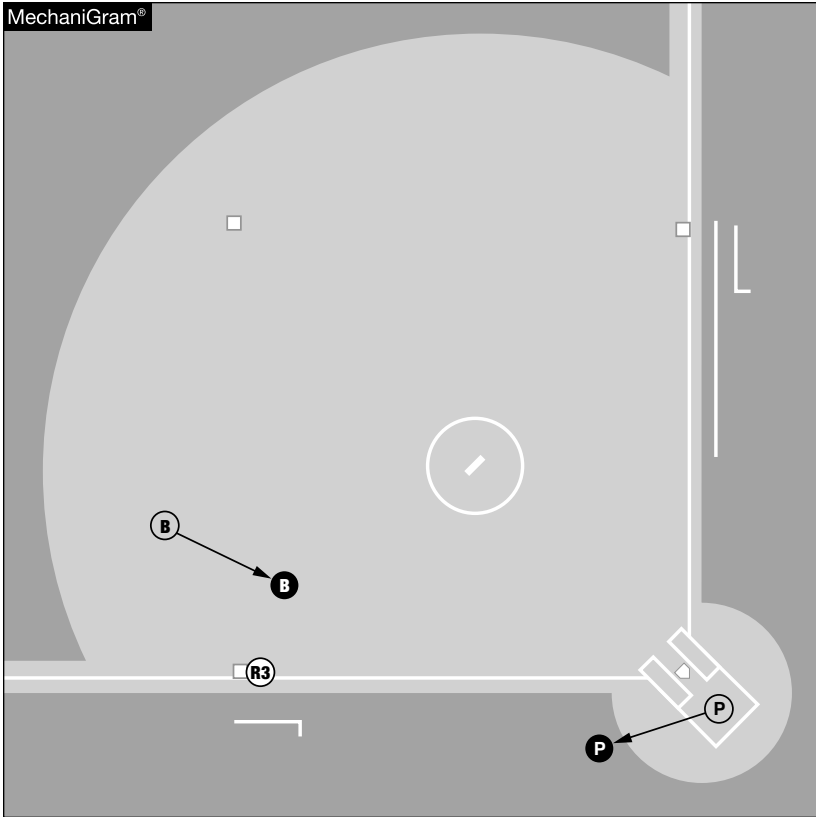

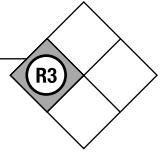

Working between pitches

P:

- Move out of stance when the pitch is over, completing verbal and/or signal.
- Remain alert to the batter's actions and the catcher for any play.

B:

- Move out of the set position, move parallel to the third/home baseline, or slightly diagonal depending on the starting depth, toward the primary position at third base.
- When the ball is in circle with pitcher and R3 has returned to first base, return to starting position.

Pickoff

P:

- When the pitch is over, watch the catcher's attempt to throw and look for batter interference.
- After the throw, step out clearing the catcher and batter to watch the play at third base; be prepared to give help if requested.

B:

- Move out of the set position, move parallel to the third/home baseline, or slightly diagonal depending on the starting depth, toward the primary position at third base.
- Watch for a possible play or obstruction.





Runner on Third Hit to the Infield

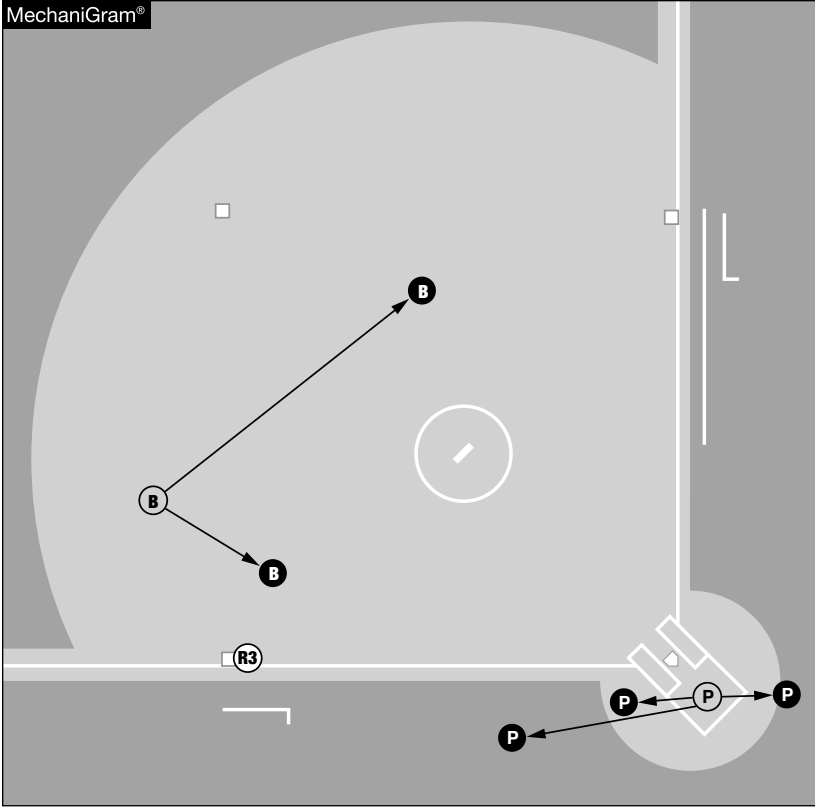

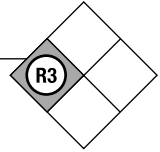

P:

- If the initial play is to the plate, make all calls at home plate.
- If the initial play is to first base, move toward the holding area as you watch the play.
 - Make all calls on R3 at third base or home plate.

B:

- When the initial throw is to first base, move into the diamond as far as possible to get the best angle and distance for the force play at first base. Make all calls on the BR at first base.
- If the BR is out at first base, watch the play at 3B.
- If the BR is safe at first base, commit toward the BR, staying out of throwing lanes.
- When the initial throw is to third base move straight into the diamond toward the primary position at third base, staying out of the throwing lane.





Runner on Third

Fly ball/Line Drive - Ball is Caught

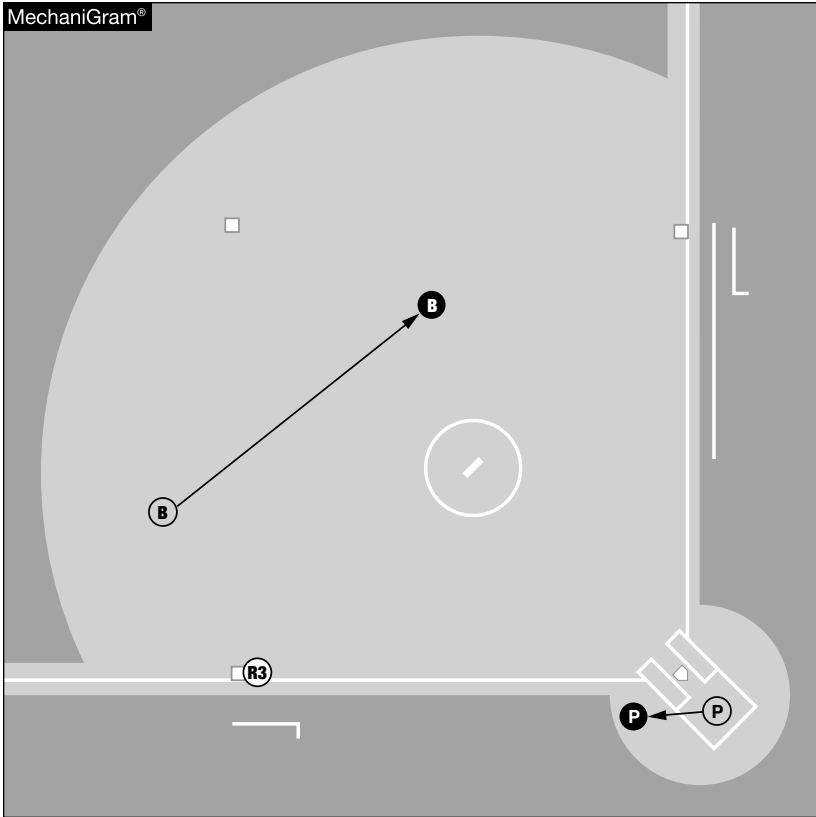

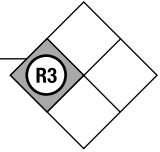

P:

- Move to obtain the best angle to watch the catch/no catch and the tag up at third base.
- Make all calls on R3 at third base and home plate.

B:

- Immediately move across the field toward first base.



Runner on Third Hit to the Outfield

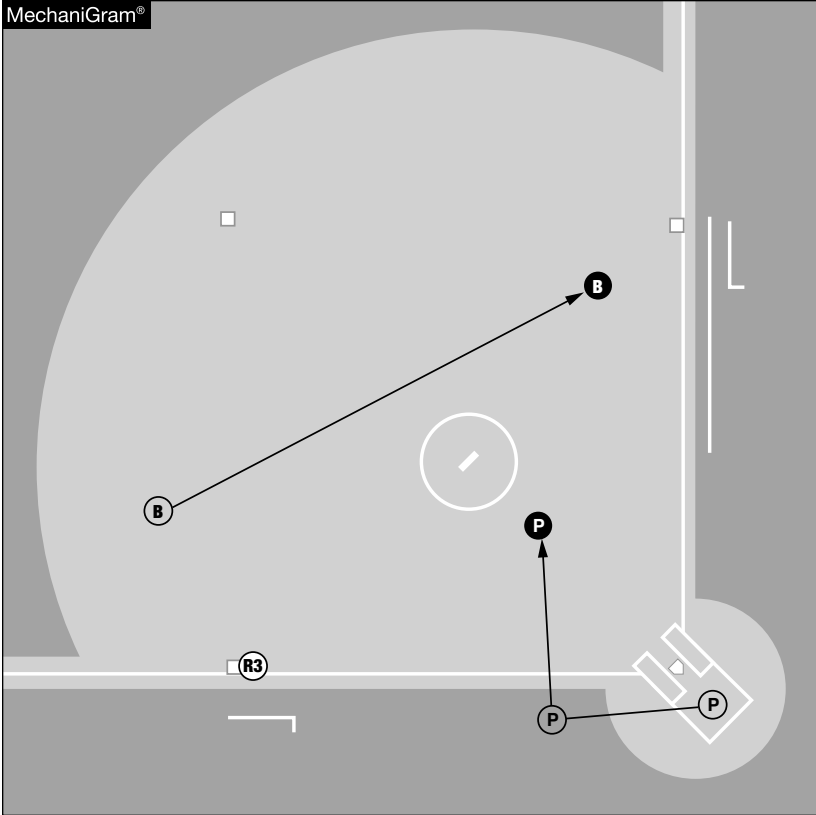

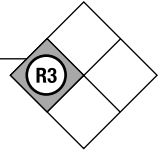

P:

- Watch R3 touch home then move into the diamond toward the holding area in front of the circle.
- As the BR advances to third base, move to the point of plate holding area.

B:

- Move into the diamond.
- Make all calls on the BR at first, second and third base.



Runners on First and Second

Working Between Pitches, Pickoff, Steal

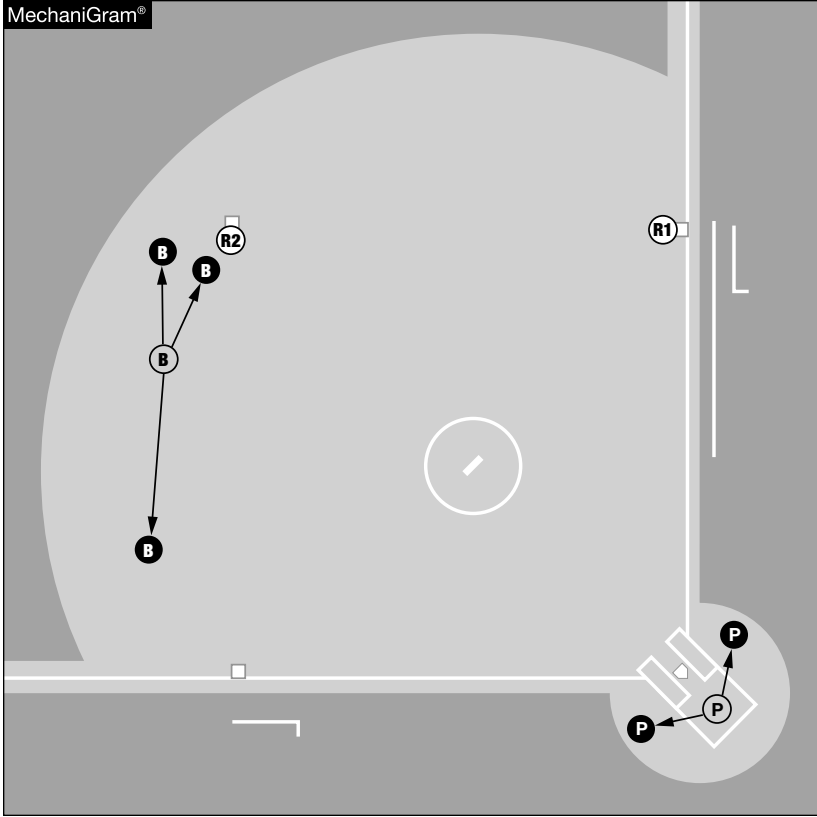

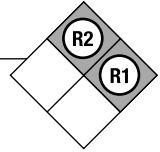

Working between pitches and pickoff attempt

P:

- Move out of stance when the pitch is over, completing verbal and/or signal.
- If there is a pickoff attempt watch the catcher's attempt to throw and look for batter interference. After a throw, step out clearing the catcher and batter to watch the play; be prepared to give help if requested, especially if the play is to first base. Be ready to help with a play at third base on R2 if the initial play is to first base.
- If the pitch is a passed ball, remain in the plate area avoiding any throwing lanes to third base.
- Keep tracking the ball and make the call on any play on the ball (blocked ball, interference, enters dead ball area, etc.).

B:

- Move out of the set position, move parallel to the second/third baseline or slightly diagonal depending on the starting depth, toward but not completely to the primary position at second base.
- If the play goes to first base continue forward and try to get closer to first base.

Steal of third base

P:

- Move out of stance when the pitch is over, completing verbal and/or signal.
- Step out clearing the catcher and batter to watch the play.
- Be ready to take a subsequent play at the plate on an overthrow.

B:

- Move out of the set position, move parallel to the second/third baseline or slightly diagonal depending on the starting depth, toward but not completely to the primary position at third base.





Runners on First and Second

Hit to the Infield

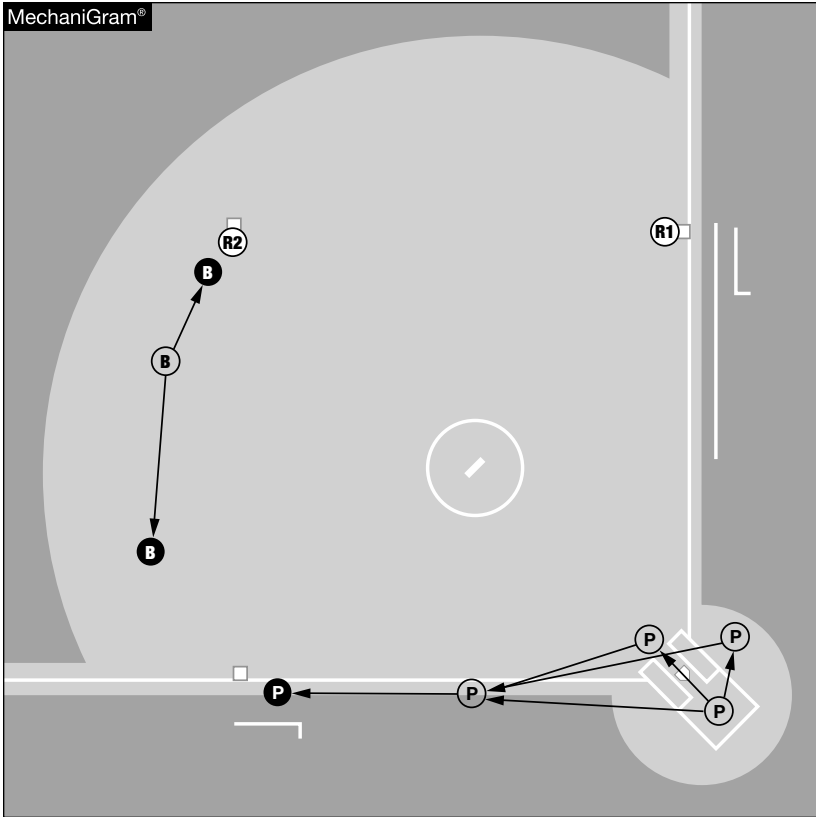

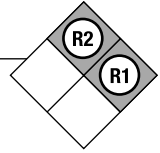

P:

- Start moving toward the holding area in foul territory between third base and home plate as you watch any play develop at any of the bases.
- If the first play is not to third base, commit to third base as you watch the play at first or second base.
- Make all calls at third base on any play after the initial play and a subsequent play at home.

B:

- Read the fielder and be ready to move quickly toward the play being made.
- After the play at first base, turn toward a potential play at second base and watch the play at third base.
- Be prepared for a double play attempt.



Runners on First and Second

Fly ball/Line Drive - Ball is Caught

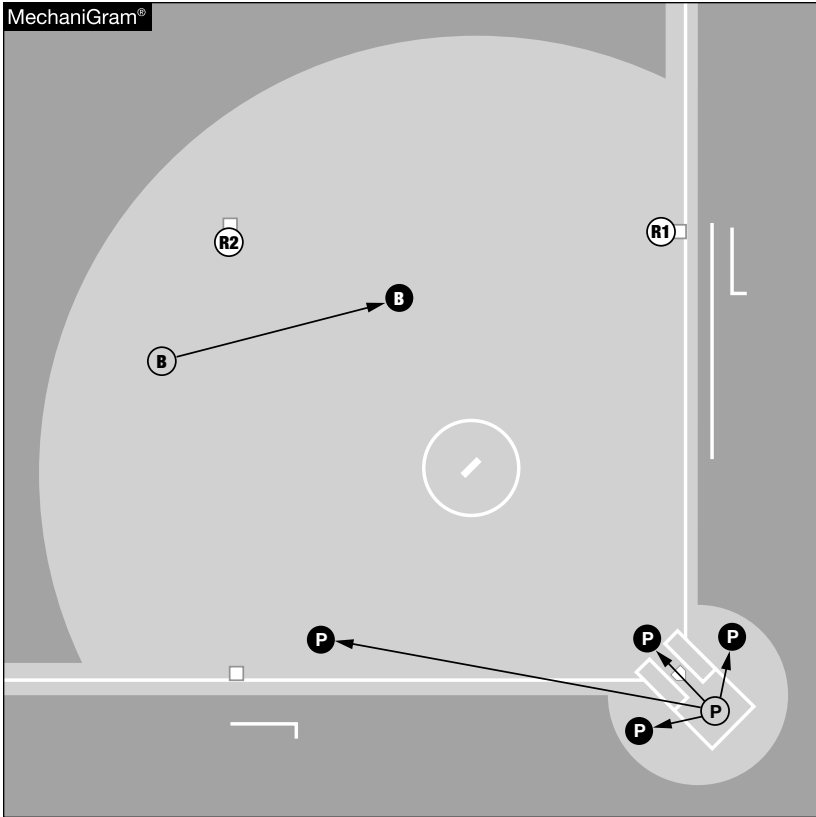

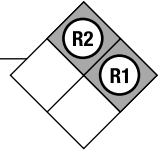

P:

- Move into the infield in the direction of the flight of the ball.
- Make all calls on R2 at third base and home plate.

B:

- Move to a position to allow you to see both R1 and R2 tag up.
- Make all calls at first or second base.
- Watch for a subsequent play at second and third base if the plate umpire is making the call at home plate.



Runners on First and Second

Hit to the Outfield

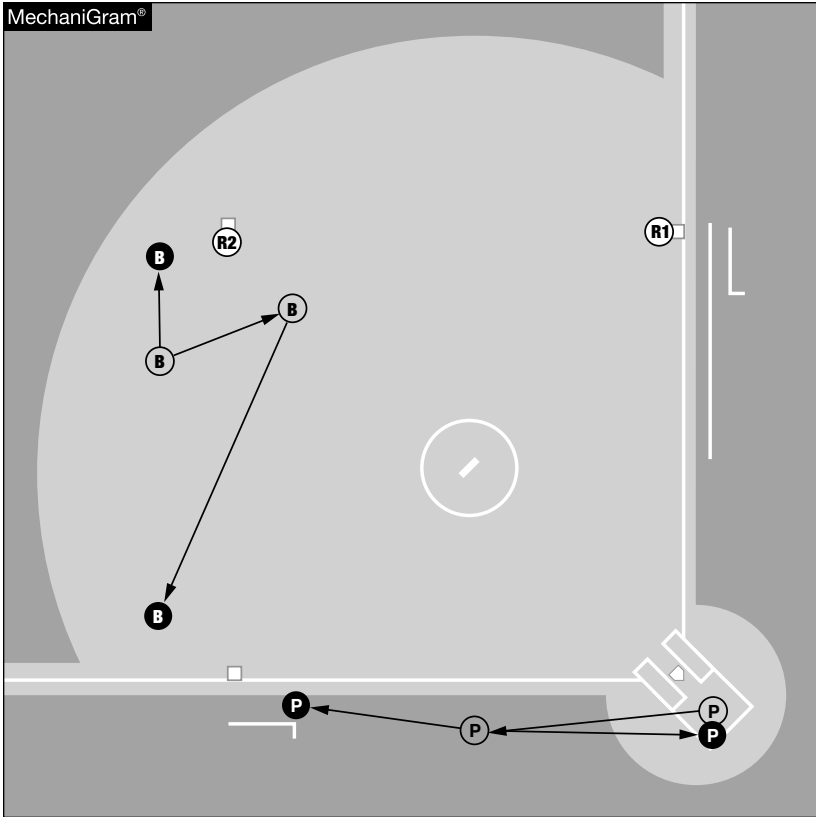

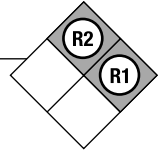

P:

- Move to the holding area in foul territory between home plate and third base; read the play and move closer to third base or home plate as appropriate.
- Make all calls at third base on R2 and R1, make all calls at home plate.

B:

- Stay outside the diamond or move inside, reading where the most possible play will be.
- Make all calls at second base.
- Make all calls on the BR at first, second and third base.
- Watch for a subsequent play at second and third base if the plate umpire is making the call at home plate.



Runners on First and Third Working Between Pitches, Pickoff, Steal

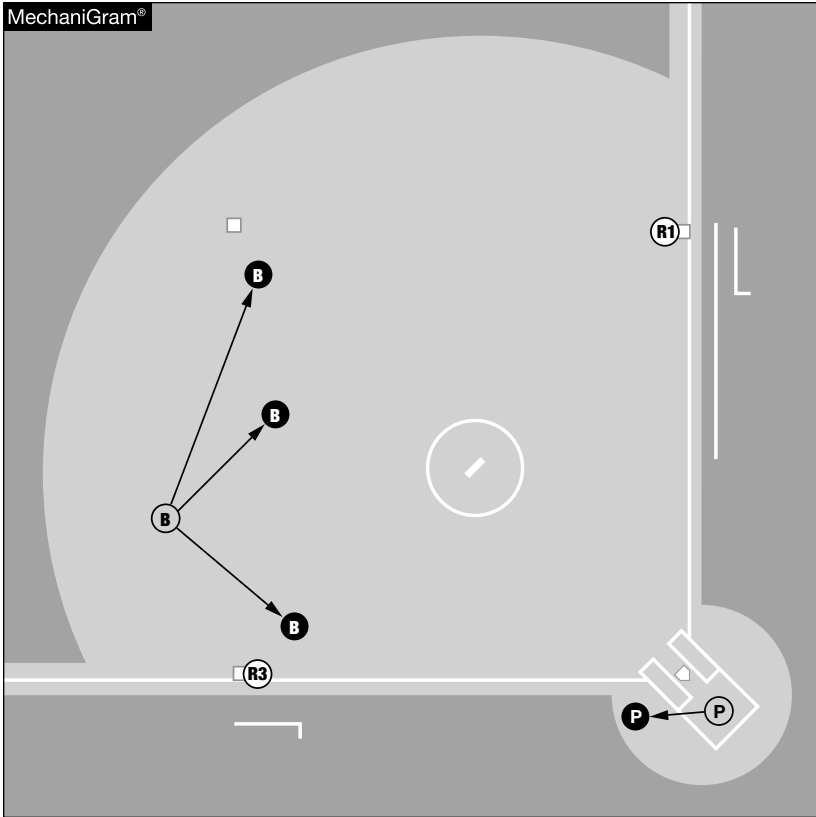

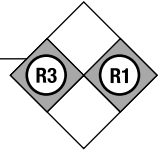

Working between pitches and pickoff attempt

P:

- Move out of stance when the pitch is over, completing verbal and/or signal.
- If there is a pickoff attempt watch the catcher's attempt to throw and look for batter interference.
 - After a throw, step out clearing the catcher and batter to watch the play; be prepared to give help if requested, especially if the play is to first base.
 - Be ready to help with a play at third base on R3 if the initial play is to first base.
- If the pitch is a passed ball, remain in the plate area avoiding any throwing lanes to third base.
 - Keep tracking the ball and make the call on any play on the ball (blocked ball, interference, enters dead ball area, etc.).

B:

- Move out of the set position, move toward the second/third baseline to achieve the angle for R3.
- If the play goes to first base continue forward and try to get closer to first base.
- If the initial play is to first base, be ready for a quick back-pick at third base.

Steal of 2b

P:

- Move out of stance when the pitch is over, completing verbal and/or signal.
- Step out clearing the catcher and batter to watch the play while moving toward the holding area.
- Read R3's actions.
- Move aggressively to third or the plate as appropriate; be prepared for a rundown.

B:

- Move out of the set position, move into the diamond to achieve the angle at second base.
- If the throw is to second base, move into the play to the best angle and distance possible.
- If the throw is cut off, read the play and be ready to stay with R1 or help with a rundown on R3.





Runners on First and Third Hit to the Infield

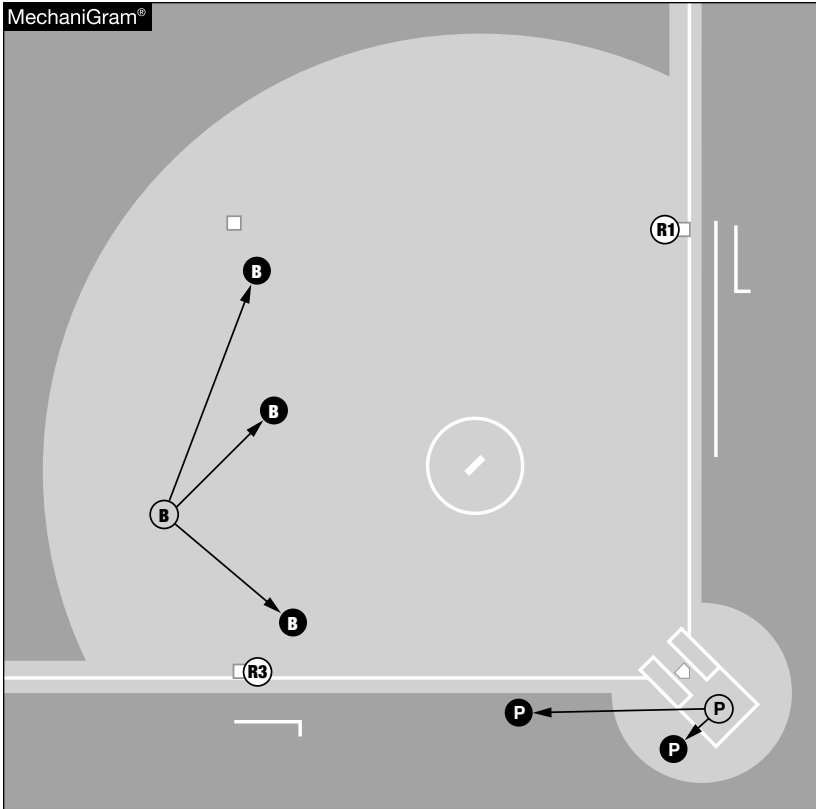

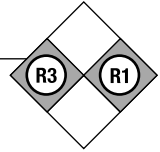

P:

- Read the play while moving toward the holding area in foul territory between third base and home plate.
- If R3 advances, move back to home plate to make the call.
- If the first play is to 2B or 1B:
 - If R3 stays at third base, move toward third base for a possible back-pick.
 - If R3 advances read the play and make all calls at home plate.

B:

- Read the fielder and be ready to move quickly toward the play being made.
- After the initial play at first base, turn toward a potential play at second base.





Runners on First and Third

Fly ball/Line Drive - Ball is Caught

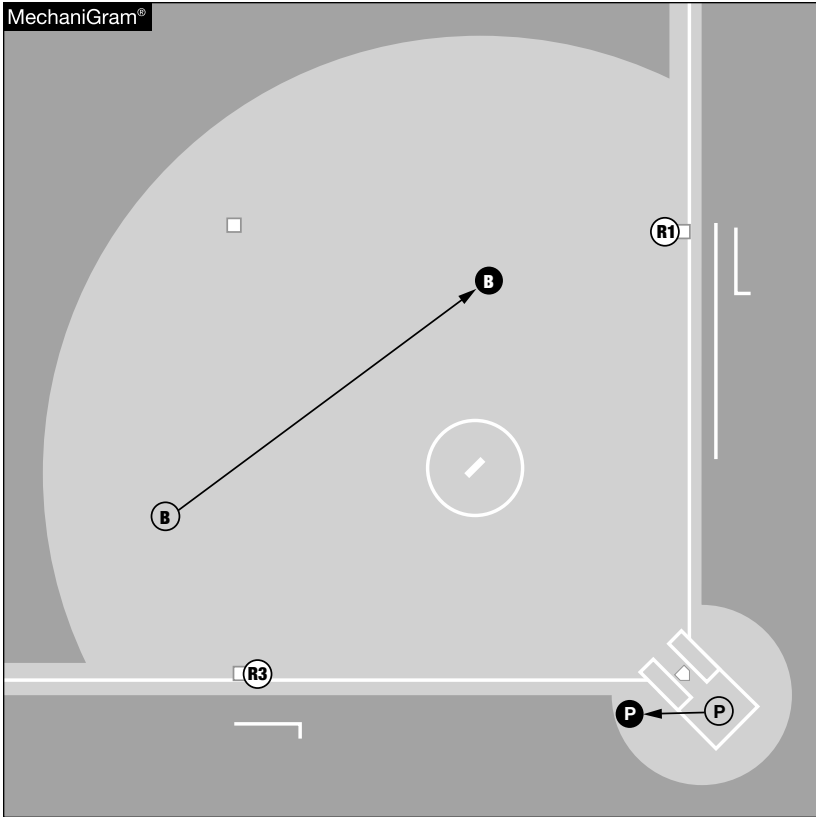

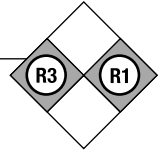

P:

- Move to obtain the best angle to watch the catch/no catch and the tag up at 3B.
- After the catch, read the action at third base:
 - If R3 stays at third base, commit to third base.
 - If R3 advances, read the play as it develops and make all calls at home plate.

B:

- Move to a position to allow you to see R1 tag up.
- Make all calls on R1 at first, second or third base.





Runners on First and Third Hit to the Outfield

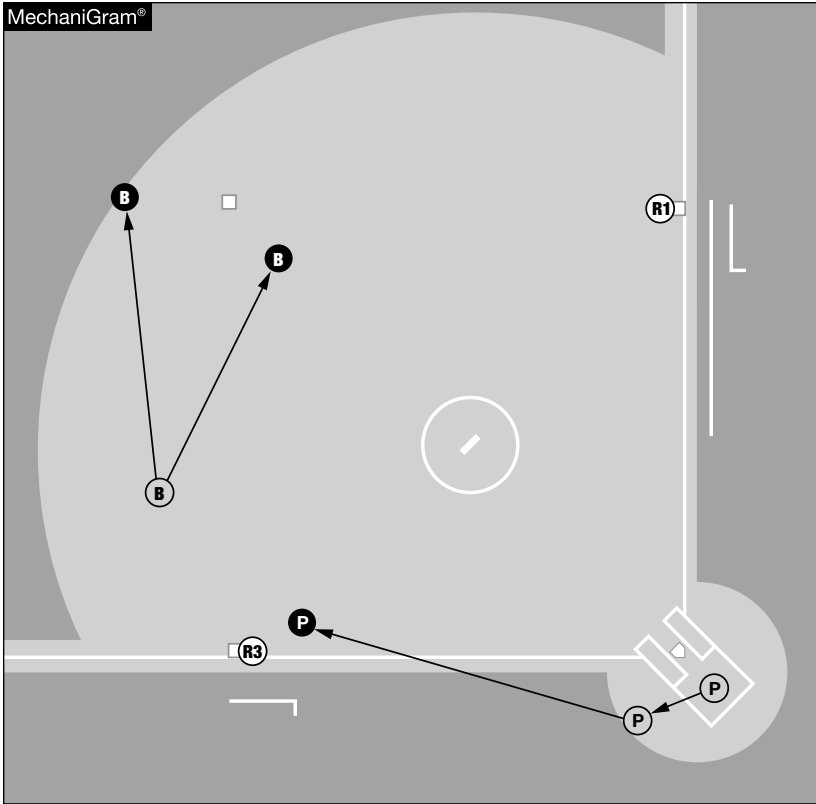

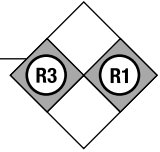

P:

- Watch R3 touch home plate.
- Move to the holding area in foul territory between third base and home plate.
- Make all calls on R1 at third base. Make all calls at home plate.

B:

- Stay outside the diamond or move inside, reading where the most possible play will be
- Make all calls at first and second base.
- Make all calls on the BR at third base.



Runners on Second and Third Working Between Pitches, Pickoff

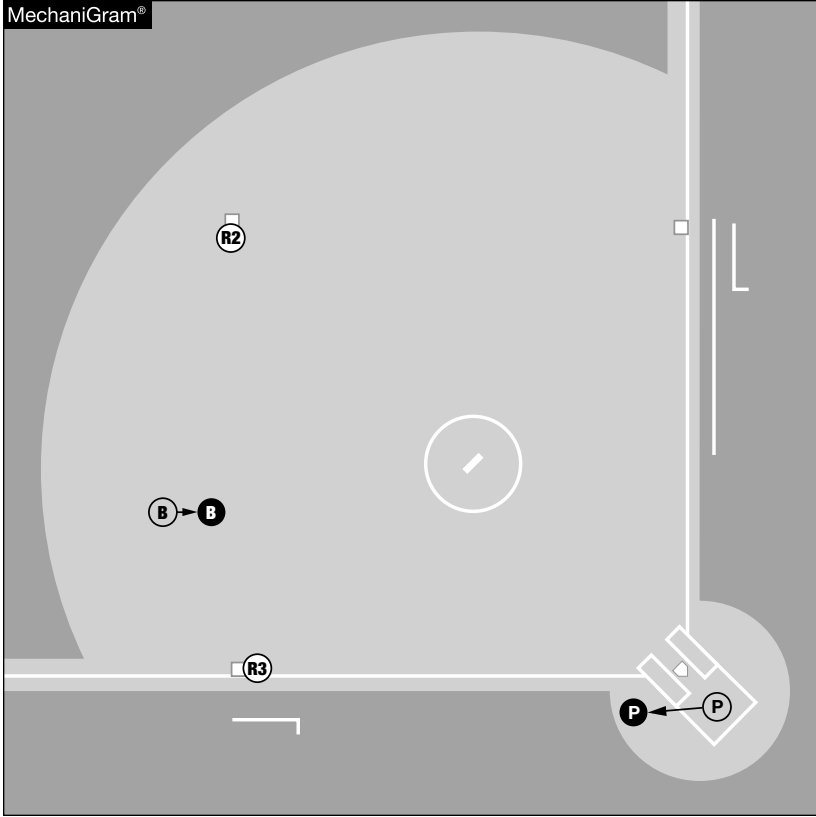

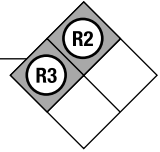

P:

- Move out of stance when the pitch is over, completing verbal and/or signal.
- If there is a pickoff attempt, step out clearing the catcher and batter to watch the play.
 - Be prepared to give help if requested.
- If the pitch is a passed ball, remain in the plate area avoiding any throwing lanes and the catcher.
 - Keep tracking the ball while watching R3 and the catcher.
 - Adjust to any play at home plate.

B:

- Move out of the set position and read the runners and catcher.
- Movement should be forward in the direction of the intersection with the imaginary line between the primary position at second and third base.
- React quickly if a play develops, getting the best angle and distance for the play.
- Be ready for a subsequent throw to the other base after the initial play.
- When the ball is in circle with the pitcher and all runners have returned to first base, return to starting position.



Runners on Second and Third Hit to the Infield

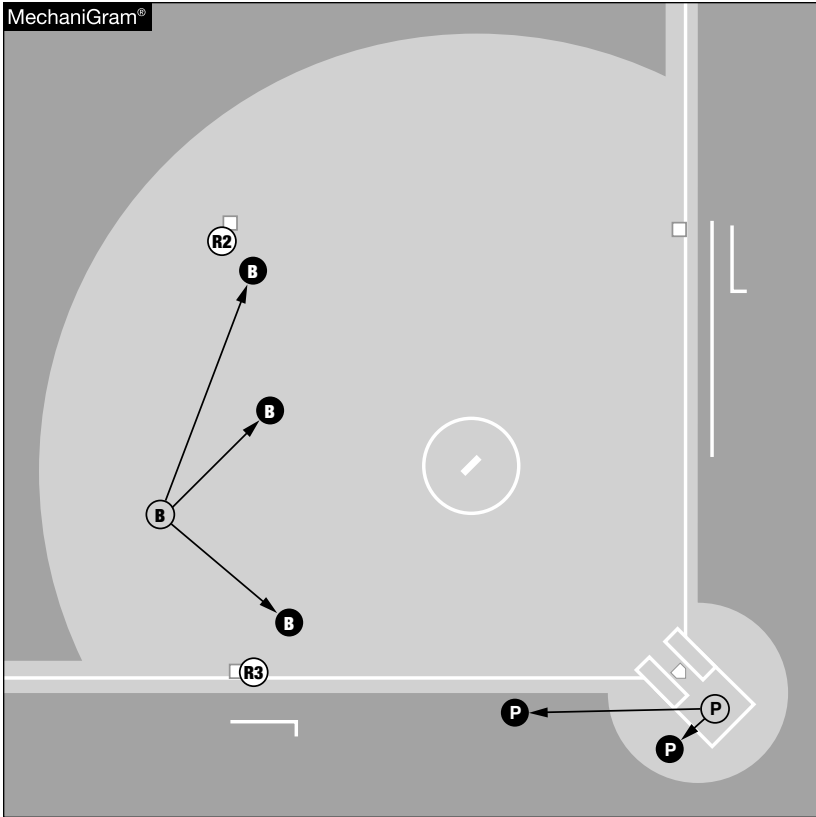

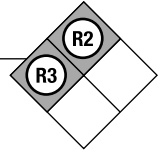

P:

- Take a few steps to your left and read R3.
- If R3 is advancing to the plate, make all calls at home plate.
- If the first play is to first base or second base:
 - If R3 stays at third base, move toward third base for a possible back-pick; make all calls at third base.
 - If R3 advances, move back to the plate area and make all calls.

B:

- Read the fielder and be ready to move quickly toward the play being made at any base.
- After the initial play at first base, turn toward a potential play at second base.



Runners on Second and Third

Fly ball/Line Drive - Ball is Caught

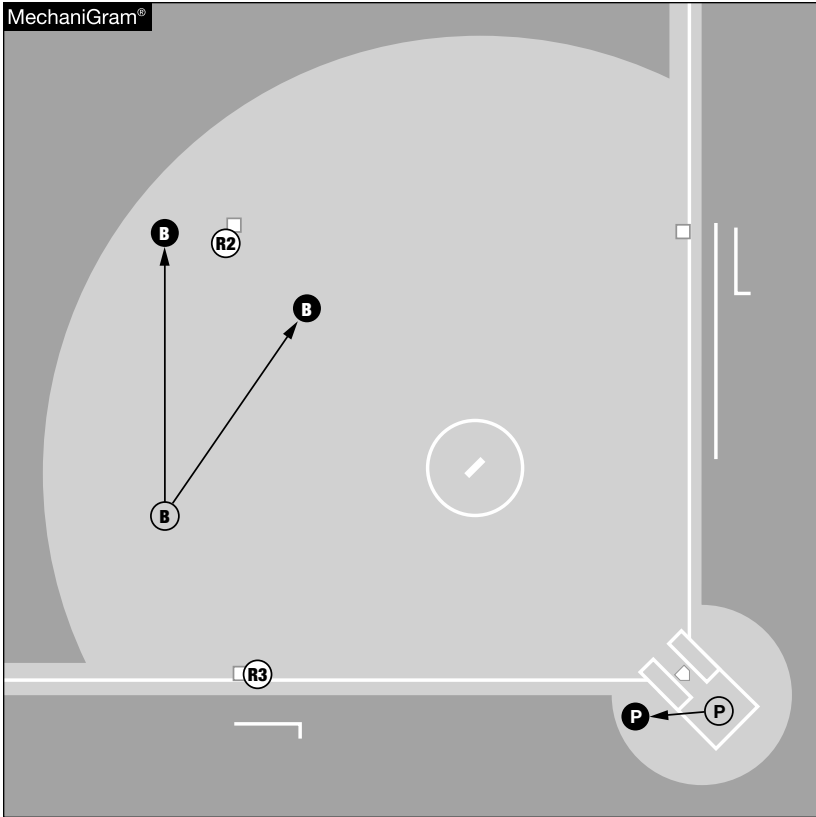

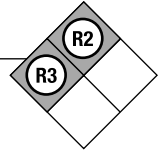

P:

- Move to obtain the best angle to watch the catch/no catch and the tag up at third base.
- After the catch, read the action at third base:
 - If R3 stays at third base commit to third base.
 - If R3 advances, make all calls at home plate.

B:

- Move to a position to allow you to see R2 tag up.
- Make all calls on R2 at second and third base.



Runners on Second and Third Hit to the Outfield

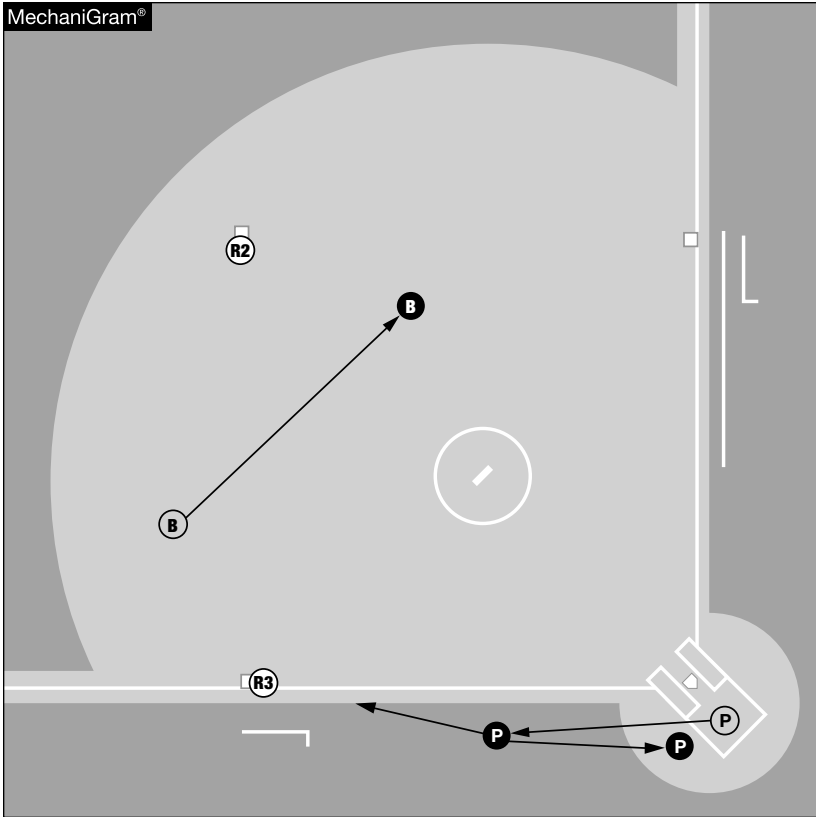

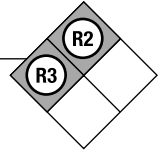

P:

- Move to the holding area in foul territory between home plate and third base while watching R3 touch home plate.
- Make all calls on R2 at third base.
- Make all calls at home plate.

B:

- Move inside the diamond.
- Make all calls on the BR at first, second and third base.



Bases Loaded

Working Between Pitches, Pickoff

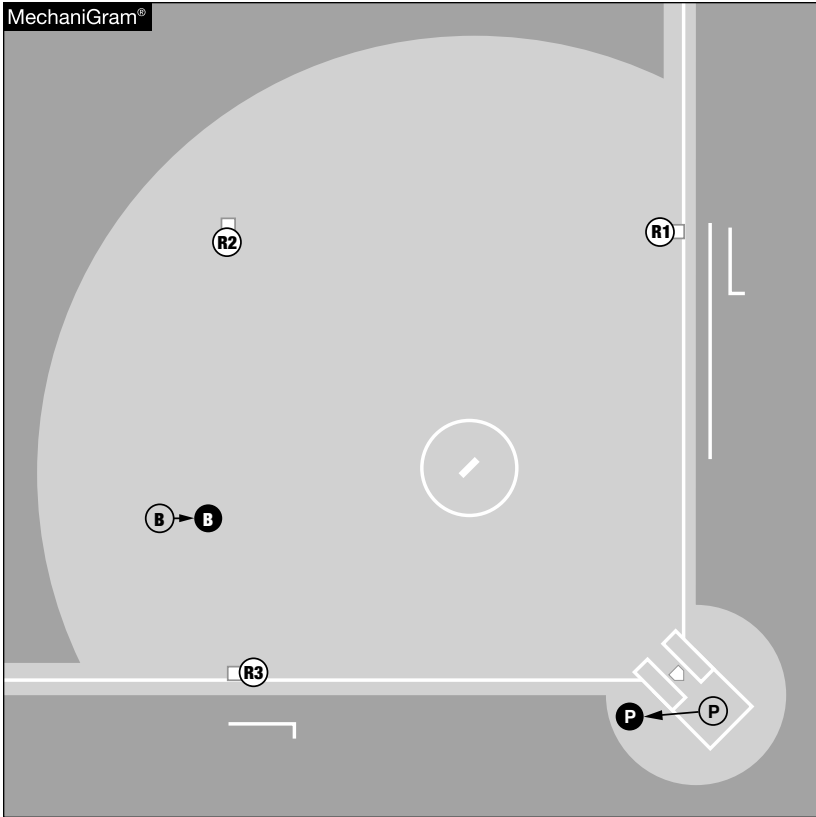

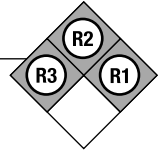

P:

- Move out of stance when the pitch is over, completing verbal and/or signal.
- If there is a pickoff attempt watch the catcher's attempt to throw and look for batter interference.
 - After a throw, step out clearing the catcher and batter to watch the play.
 - Be prepared to give help if requested, especially at first base.
 - Be ready for R3's attempt to advance to home plate.
- If the pitch is a passed ball, remain in the plate area avoiding any throwing lanes and the catcher.
 - Keep tracking the ball while watching R3 and the catcher.
 - Adjust to any play at home plate.

B:

- Move out of the set position and read the runners and catcher.
- Movement should be forward in the direction of the intersection with the imaginary line between the primary position at second and third base.
- React quickly if a play develops, getting the best angle and distance for the play.
- Be ready for a subsequent throw to other bases after the initial play.
- When the ball is in circle with the pitcher and all runners have returned to first base, return to starting position.





Bases Loaded Hit to the Infield

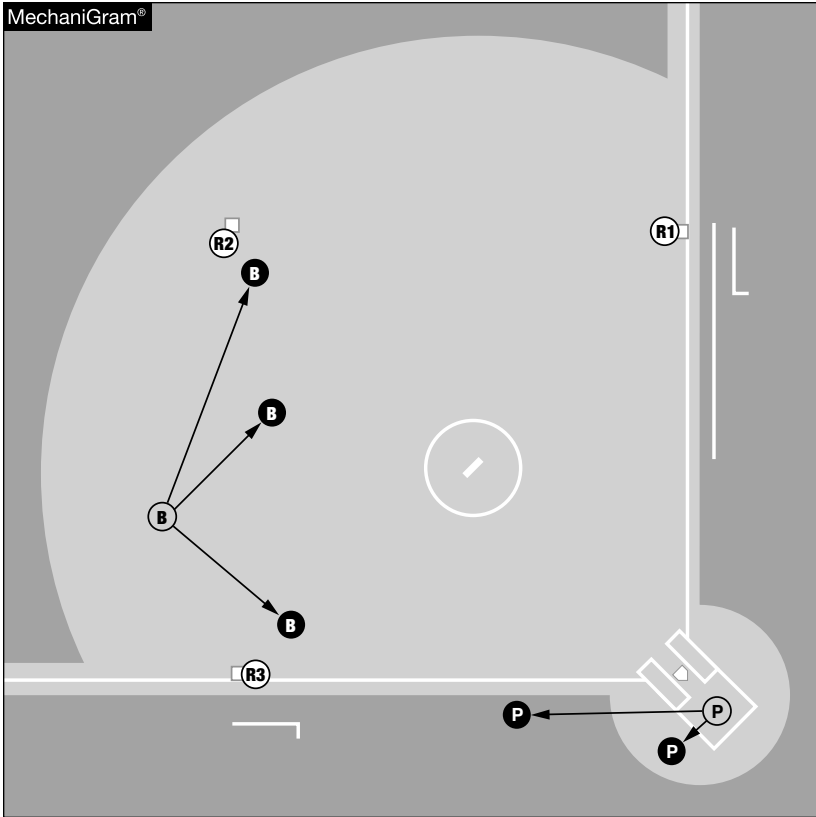

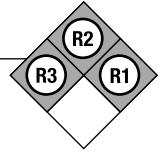

P:

- Make all calls at home plate.
- If the first play is not to the plate, watch R3 touch home plate.
- Be ready to move to third base for any subsequent play on R2 or R1.

B:

- Read the fielder and be ready to move quickly toward the play being made.
- If the initial play is to the plate, move aggressively toward first base staying out of running lanes for the potential double-play attempt at first base.
- If the initial play is to first base, when that play is over turn toward a potential play at second base.





Bases Loaded

Fly ball/Line Drive - Ball is Caught

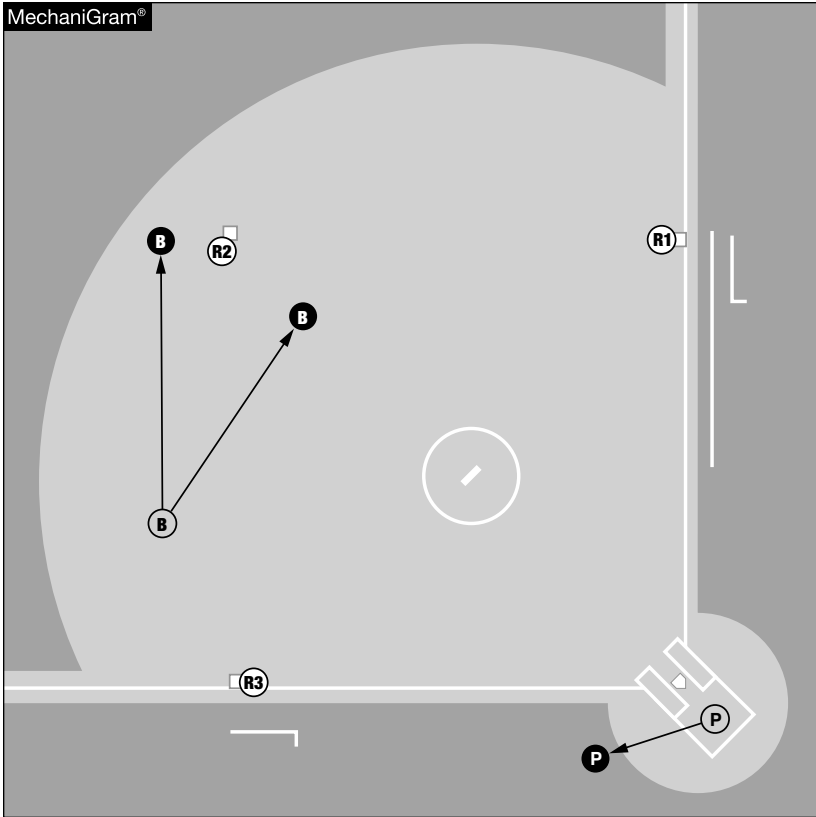

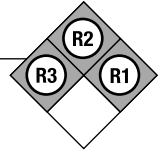

P:

- Move to obtain the best angle to watch the catch/no catch and the tag up at third base.
- After the catch, read the action at third base:
 - If R3 stays at third base, commit to third base.
 - If R3 advances, read the play.
- Make all calls on R2 at third base if the initial throw goes there.

B:

- Move to a position to allow you to see R1 and R2 tag up.
- Make all calls at first and second base.
- Be ready to take any play at third base until you hear the plate umpire verbalize coverage at third base.





Bases Loaded Hit to the Outfield

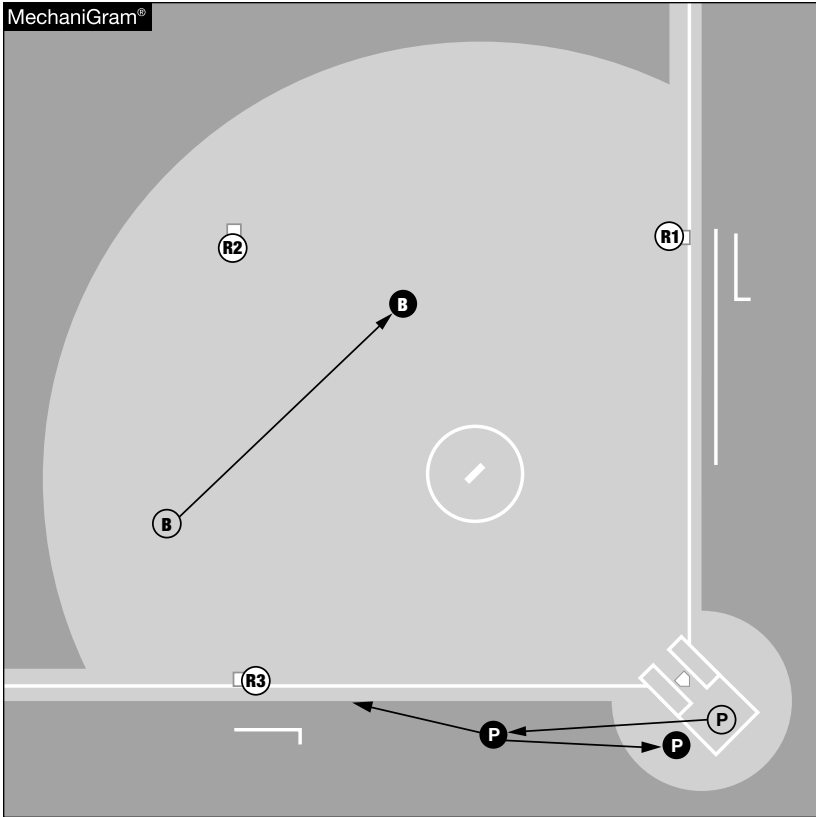

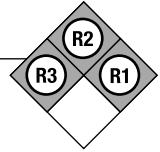

P:

- Move to the holding area in foul territory between home and third base.
- Watch R3 approach and touch home plate.
- If you read a possible play at third base on R2, watch R3 touch the plate then commit to third base.
- Take any play on R2 or R1 at the plate.
- As soon as you read that R2 will score without a play and there is a possible play on R1 at third base, commit to third base and adjust to the play; verbalize coverage at third base.
- As soon as you read that R1 will advance to the plate, move back to the plate and adjust to the play.

B:

- Make all calls at first and second base.
- Make all calls on the BR at third base.
- Be ready to take any play at third base until you hear the plate umpire verbalize coverage.



Section



Definitions

90-Degree Angle — Tag

The concept determines the umpire's location on tag plays. The path of the runner into a base or the application of the tag on a play not involving a base, together with the umpire's line of vision from a location 3-to-10 feet away, form a 90-degree angle.

90-Degree Angle — Throw

The concept determines the umpire's location on force plays. The path of the thrown ball to a base together with the umpire's line of vision from a location no closer than 18 feet from the base, form a 90-degree angle.

Accurate Zone

Interprets and calls a strike zone as defined in the NCAA rulebook.

Base Line

The imaginary straight line between the bases

Base Path

An imaginary straight line between the base and a base runner when a play is being made on that runner.

Calling Depth

The preferred distance from a play that enables the umpire to see all the necessary elements of the play.

- A force play should be viewed from a depth not closer than 18 feet, allowing the umpire to see, without moving their head, all three elements of a force play: the ball in the fielder's glove, the base runner touching the base, and the fielder's foot on the base.
- A tag play should be viewed from an approximate distance of 3 to 10 feet, allowing the umpire to see the elements of a tag play: the application of the tag, or the application of the tag and the runner touching the base. There may be times when the need to see multiple, diverse angles or the position of the players' bodies, necessitates that the umpire move closer or even look over the top of the play to see the action clearly.

Chase

The act of a base umpire who abandons their normal infield duties and assumes the responsibilities for a fly ball (catch/no catch, fair/foul, dead ball).



Counter-Rotated Starting Position

The starting position of the base umpires with runners on:

- Second only
- First and second
- First and third
- Second and third
- First, second and third

The first-base umpire: Start in a set position, squared to home plate, between 15 feet from second base and the 15 feet from first base, no more the 15 feet beyond the baseline or behind F4.

The third base umpire: Start in a set position, slightly angled towards the infield (opposite baseline between home and first base), completely in foul territory, close to the line, 6-12 feet beyond third base.

Crewness

The unspoken awareness, understanding, and acknowledgment that umpires are a team. Umpires are continually aware of the movement and position of partners and responds/reacts appropriately. Umpires use proper verbal and non-verbal communication with each other. Umpires have eye contact with partners between hitters and during developing plays. Umpires are cooperative, supportive, and respectful of each other in all areas.

Elements of Plays

One element play; a tag play that involves seeing a tag applied and does not involve a base.

Two element play; a tag play that involves seeing a runner touch a base and seeing a tag applied.

Three element play; a force play that involves seeing a fielder's foot on a base, a runner touch a base, and the ball into the fielder's glove.

Game management

Establishing and maintaining an appropriate game pace and tone. The umpire's ability to listen and handle game issues in a professional manner. To be alert to possible problems and resolve conflict correctly and in a timely manner.

Holding Area/Holding Zone

An area on the field where an umpire determines their next move.

Judgment

Rendering a decision based on what was seen when in the correct position.



Non-Slot Foot

The umpire's right foot on a right-handed batter and the left foot on a left-handed batter.

Off-field Conduct

Umpires conduct themselves and dress in a manner that reflects positively on themselves, fellow umpires and the NCAA. Uses good judgment to remove themselves from any potentially compromising situations and has the respect of fellow umpires

Onfield conduct

Umpires are respectful of all softball constituents. An umpire does not encourage, initiate or invite non-job related conversations with coaches or players. An umpire is respectful when approached by a coach.

Pivot

The efficient movement used by an umpire to get from one point to another or to open to the impending play. The pivot entails planting one foot, turning the body on this foot and ending in a shoulder width stance with the ability to move to the right or to the left.

Primary Position

The initial location used by an umpire to rule on a play as the base runner approaches a base or as a play develops. Primary positions are determined by the prospect of a traditional play. The umpire's line of vision forms a 90-degree angle perpendicular to:

- The path of the base runner on a tag play into a base
- The application of the tag on a tag play not involving a base
- The path of the flight of the ball on force plays

Rotated Starting Position

The starting position of base umpires with a runner on first base only. U1 is on the first-base line in foul territory at calling depth for a tag play. U3 is set up 10-18 feet from second base between the first and third baseline extended. Base your choice of position and depth on the probability of a steal, the current game situation including the count and number of outs, and your knowledge of the offense and defense. This starting position may change on a pitch by pitch basis, continue to evaluate it during the at bat.

Secondary Position

The next primary position assumed by the umpire after the initial play during continuous action.

Set: Bases

Body position of a base umpire prior to a pitch. The body is not moving, the feet are more than shoulder width apart and parallel to each other. The hands are drawn into or placed on the body in a locked position. Set refers to either a ready set or hands-on-knees set position.



Set: Hands-on-Knees

Body position of a base umpire prior to a pitch. The body is stopped, not moving, the feet are comfortably wider than shoulder width apart and parallel to each other. The hands, with thumbs on the inside of the leg, are grasping the knees. The umpire is bent at the knees in a sitting position.

Set: Plate

From the stance, a plate umpire drops into the set position just prior to the release of the pitch. The amount of drop necessary is determined by the width of the feet in the stance. The umpire's head is ideally just above the catcher's head. The umpire's chin is on a line with the top of the catcher's head. The umpire's chin should not be lower than the top of the catcher's helmet, but the top of the umpire's head should never be even with or below the top of the catcher's head. The umpire must be able to see the outside edge of the plate and the batter's knees. Some torso lean may be needed to achieve proper height. Hands/arms should be in close to the body. Their placement provides balance and assists in locking-in (not moving) during the pitch. A good lock-in relies on bone structure, not muscles. The umpire must be completely set when the pitch is released and remain motionless as the pitch is delivered. The same position should be mirrored on both sides of the plate. The set position must be balanced and comfortable, but it is not a relaxed position.

Slot

The area between the catchers's inside shoulder and the batter when the batter is in their natural batting stance, and the catcher is in their normal catching position behind the plate. To achieve a slot position in all stances, place the non-slot foot; right foot on right-handed batters, about midway between the catcher's feet. Spread the other foot; the slot foot slightly more than shoulder width, which brings the nose between the catchers's inside shoulder and the batter's body. To check the slot position, look at the outside corner and the batter's knees. The umpire must be able to see both clearly. The slot affords the umpire an excellent line of sight for seeing the zone, checked swings, hit batters, batter hit with batted ball, and catch/no-catch by the catcher.

Slot Foot

The umpire's left foot on a right-handed batter and the right foot on a left-handed batter.

Stance: Plate

The approved plate stances are the box stance, heel/toe stance, Gerry Davis, and modified Gerry Davis. The position and foot placement the plate umpire establishes behind the catcher prior to dropping set. The stance must allow the umpire to drop to a rock solid set position and remain motionless while the pitch is delivered. The stance must be in the slot and, after dropping set, afford the umpire an unobstructed view of the entire zone. The stance used for right-handed batters must be mirrored for left-handed batters.



Standard Starting Position

The starting position of base umpires with no runners on base or a runner on third base only. U1 is 18-to-20 feet beyond first base completely in foul territory. U3 is either 18-to-20 feet beyond third base completely in foul territory or, with a runner on third, in a set position 6-to-12 feet beyond third base completely in foul territory.

Starting Depth

- With no runner on base: 18-to-20 feet beyond the base, on the line in foul territory.
- With a runner(s) on base: 6-to-12 feet beyond within a foot of the line, unless pushed foul by a runner at third to see a check swing.

Starting Position

The location of the umpires as the ball is readied for play prior to the next pitch. There are three Starting Positions:

- Standard
- Rotated
- Counter-Rotated

Third Dimension

The need to see simultaneous angles in order to see the play, move in and look over the top of the play.

Tracking: Plate

See the release of the pitch, follow it in to just in front of the plate, switch focus to the batter's zone, and then see the ball into the catcher's glove. Observe the entire flight of a pitch with only slight head movement as the ball is followed in.

Walk the Line

Walking the line is a method base umpire use to coordinate pre pitch to post pitch responsibilities. Coordinate the walk with the responsibilities. You can take one or two steps when walking the line. Finish your last step on the outside foot prior to the ball arriving at the the plate so you are ready for any action.

Wedge: Outfield Ball Coverage

The area within the imaginary lines drawn from the plate to the right fielder and the plate to the center fielder. This is a coverage area for U1 when counter-rotated.

Working Between Pitches

Movement of the umpire toward a possible play after a pitch is not hit. If there is no immediate play to a base by the catcher on a pitch not hit, the umpire should move toward a position for a possible delayed play on a base runner for which they are responsible.

